



POLARIS II LAMINATOR OPERATOR MANUAL

Part Number: 930-115 REV: - REV Date: 7-27-04

© 2004 GENERAL BINDING CORPORATION. ALL RIGHTS RESERVED.

Do not duplicate without written permission.



The information in this publication is provided for reference and is believed to be accurate and complete. General Binding Corporation is not liable for errors in this publication or for incidental or consequential damage in connection with the furnishing or use of the information in this publication, including, but not limited to, any implied warranty of fitness or merchantability for any particular use.

General Binding Corporation reserves the right to make changes to this publication and to the products described in it without notice. All specifications and information concerning products are subject to change without notice.

Reference in this publication to information or products protected by copyright or patent does not convey any license under the rights of General Binding Corporation or others. General Binding Corporation assumes no liability arising from infringements of patents or any other rights of third parties.

This publication is copyrighted © 2004 by General Binding Corporation. All rights reserved. The information contained in this publication is proprietary and may not be reproduced, stored, transmitted, or transferred, in whole or in part, in any form without the prior and express written permission of General Binding Corporation.

Table of contents

1.0 Safety	
1.1 Explanation of symbols	1-1
1.2 General rules of safety	1-1
1.3 Labels	1-3
Figure 1.3.1 Safety label placement	1-5
2.0 Warranty	
2.0 Warranty	2.1
3.0 Specifications	
3.1 Film and sheet size	3-1
3.2 Functions	3-1
3.3 Weight	3-1
3.4 Dimensions	3-1
3.5 Electrical requirements	3-1
3.6 Recommended work space	3-1
Figure 3.4.1 Dimensions	3-2
4.0 Installation	
4.1 Pre-installation	4-1
4.2 Setting up your laminator	4-2
Figure 4.2.1 Paper Guide	4-2
5.0 Operations	
5.1 Components on the laminator	5-1
Figure 5.1.1 Power Switch	5-1
Figure 5.1.2 Feed Table Details	5-1
Figure 5.1.3 Catch Table	5-2
Figure 5.1.4 Vacuum Adjustment	5-2
Figure 5.1.5 Air and Vacuum Gauges	5-2
Figure 5.1.6 Guide Wheels	5-2
Figure 5.1.7 Heat Roller and Shield	5-3
Figure 5.1.8 Pull Roll	5-3
Figure 5.1.9 Paper Pin	5-4
Figure 5.1.10 Film Support Arm	5-4
5.2 Control panel	5-5
Figure 5.2.1 Control panel	5-6
5.3 Operator screens	5-7
5.4 Supply shaft	5-9
5.5 Separator knife	5-9
5.6 Film alignment	5-9
5.7 Film Tension	5-9
Figure 5.7.1 Manual Tension Knob	5-10

6.0 Applications

6.1 Film loading and threading	6-1
Figure 6.1.1 Suction Cup Control	6-1
Figure 6.1.2 Suction Cups and Paper Stack	6-1
Figure 6.1.3 Film Leader	6-2
6.2 Helpful hints	6-3
6.3 Important points to remember	6-3
Quick Set up	6-5
Application Guide	6-6

7.0 Maintenance and Troubleshooting

7.1 Cabinets and cover	7-1
7.2 Clean the rollers	7-1
7.3 Misc Maintenance	7-2
7.4 Troubleshooting	7-2
Figure 7.3.1 Troubleshooting guide	7-3

1.0 Safety



CAUTION: Do not attempt to operate your Polaris Laminator until you completely read and understand this Operations Manual.

Your safety, as well as the safety of others, is important to General Binding Corporation. This section contains important safety information which must be adhered to while operating, cleaning and performing basic maintenance in and around the machine.

1.1 Explanation of symbols



INFORMATION: *[This symbol is used prior to, during and/ or after a step. Following this symbol is important information pertaining to current subject.]*



CAUTION: *[This symbol is used prior to a step. The information following this symbol is to inform you of how to avoid harm to you and others around you]*



WARNING: *[This symbol is used prior to a step. The information following this symbol is to inform you of how to avoid a dangerous situation.]*



ELECTRICAL HAZARD: *[This symbol is used prior to a step. The information following this symbol is to prevent an electrical shock condition that may be caused by an operators action or machine function.]*

1.2 General rules of safety



ELECTRICAL HAZARD: Do not operate the laminator if power cord is damaged or frayed. You can be severely shocked, electrocuted or cause a fire.



WARNING: Do not operate this laminator if you are not physically, psychologically or emotionally fit. Do not operate this machine until you have been trained and read this manual in it's entirety.



WARNING: Do not wear ties, loose fitting clothes or dangling jewelry while operating or servicing the laminator. These items can get caught in the nip and choke you or you can be crushed or burned.



WARNING: Never tamper with the safety devices to increase the laminator's production capacity. In the event a safety device should fail, never attempt to bypass it for operation. Consult a service representative immediately.



WARNING: Never use this machine for any other purpose than its intended design and function.

CAUTION: Do not make any modifications to this laminator. Unauthorized changes will void your warranty and may cause extensive repairs or create poor output quality.



WARNING: Do not attempt to repair or service the laminator. Disconnect the plug from the power receptacle and contact your local sales/ service representative.



CAUTION: Only use acceptable materials through this laminator. Unacceptable materials may cause damage to the rollers or cause poor output quality.



CAUTION: Always observe all warning labels placed at various points on the laminator. If you do not completely understand a label, contact your local service representative for further explanation.



CAUTION: Avoid contact with the heat roller during operation or shortly after power has been removed from the laminator.



CAUTION: When moving the laminator, avoid quick stops, excessive force and uneven floor surfaces.



INFORMATION: Always disconnect the power plug from the receptacle to which it is connected and keep the power supply cord in your possession when moving the laminator.



INFORMATION: Any concerns for safety or operation should be brought to the attention of your local service representative immediately.

1.3 Labels

Safety warning labels are placed at various locations on the laminator. Do not remove any of these labels. They are placed for your safety as well as the safety of those working around you.

Below are illustrations of the safety labels and a description of their meanings.

Hot rollers

– The safety labels below mean that you could be burned and your fingers and hands could be trapped and crushed in the rollers. Jewelry and long hair could be caught in the rollers and you could be pulled into them.



One of each label is placed on each side from the front operating position just in front of the heat rollers nip.

Electrical hazard

– The safety label below means that you could be seriously hurt or killed if you open the product and expose yourself to hazardous voltage.



This label is located on the rear panel in the center of the laminator just below the film supply shaft between the pull rollers and decurling bar.

- The safety label below means that you should always replace a fuse with the same size and type of fuse. This will reduce the risk of fire.

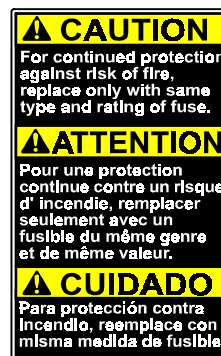

This label is located on the side cover near the fuse panel located on the rear of the machine.

Pinch point

– The safety label below means use extreme caution when placing your hands in the proximity of the pull rollers nip. You should never place your fingers or other items in this area while the machine is running.



This label is located between the pull rollers and the decurling bar center of the rollers.

– The safety label below means that you could be seriously injured if you come in contact with the moving chain and sprockets of the drive system.



This label is located near all drive sprockets on the machine.

Sharp knife

– The safety label below means that you could cut yourself if you are not careful.



This label is located on the rear panel in the center of the laminator just above the Electrical hazard safety label and below the rear slitter.

Refer to Figure 1.3.1 Safety label placement for illustration.

Figure 1.3.1 Safety label placement



(2) One on each side of the laminator



(1) Between pull rollers and decurling bar

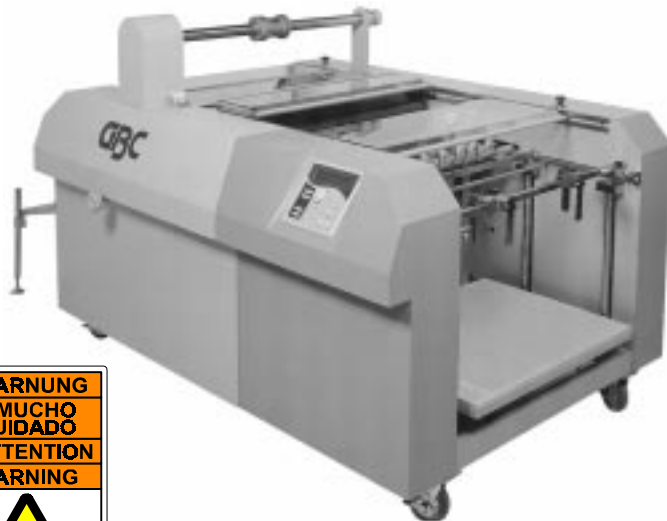

(1) Center rear panel below film unwind.



Near all sprockets



Located near Fuse Holder

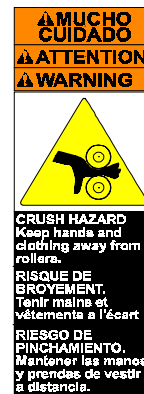

(2) One on each side of the laminator



2.0 Warranty

GBC warrants to the original purchaser for a period of ninety days after installation that this laminator is free from defects in workmanship and material under normal use and service. GBC's obligation under this limited warranty is limited to replacement or repair, at GBC's option, of any part found defective by GBC without charge for material or labor.

THIS LIMITED WARRANTY IS IN LIEU OF ALL OTHER WARRANTIES EXPRESSED OR IMPLIED. WARRANTIES OF MERCHANTABILITY OR FITNESS FOR A PARTICULAR PURPOSE ARE EXPRESSLY EXCLUDED. ANY REPRESENTATIONS OR PROMISES INCONSISTENT WITH, OR IN ADDITION TO, THIS LIMITED WARRANTY ARE UNAUTHORIZED AND SHALL NOT BE BINDING UPON GBC. IN NO EVENT SHALL GBC BE LIABLE FOR ANY SPECIAL, INCIDENTAL, OR CONSEQUENTIAL DAMAGES, WHETHER OR NOT FORESEEABLE.

This limited warranty shall be void if the laminator has been misused; mishandled; damaged by negligence, by accident, during shipment, or due to exposure to extreme conditions; repaired, altered, moved, or installed by anyone other than GBC or its authorized agents; or if incompatible film was used. GBC's obligation under this limited warranty does not include routine maintenance, cleaning, adjustment, normal cosmetic or mechanical wear, nor freight charges.

Without limiting the generality of the previous paragraph, GBC's obligation under this limited warranty does not include:

- 1. Damage to the rollers caused by knives, razors, or other sharp tools; by any foreign objects falling into the working area of the laminator; or by cleaning the laminator with solutions or materials that harm its surfaces;***
- 2. Damage caused by adhesives; nor***
- 3. Damage caused by lifting, tilting or attempting to position the laminator other than rolling it on its castors across even surfaces.***

For European Union Residents Only: This guarantee does not affect the legal rights which consumers have under applicable national legislation governing the sale of consumer goods.

This page intentionally left blank.

3.0 Specifications

This section provides specific information regarding the laminator. Any specification not provided must be requested from GBC.

3.1 Film and sheet size

Film – Single side films
(ie., GBC LAYFLAT, GBC HI-TAC)

Core – 3 in. (7.6 cm)

Sheet Size – Min. 11.0 in. x 8.5 in. (28x 20 cm)
– Max. 25 in. x 25 in. (64 x 64 cm)

Sheet Weight – Min. 24 lb. bond
– Max. 10 pt. board

Pile Height – 17 in. (44 cm)

Main Roll Diameter- 10.0 inches (24 cm)

3.2 Functions

Speed < up to 50 ft./ min (6 m/ min.)

Temperature – 7 Settings
225, 240, 250, 260, 270,
280, 290 deg. F

3.3 Weight

Unpacked – 1870 lbs. (850 kilograms)

Shipping Weight – 2156 lbs. (980 kilograms)

3.4 Dimensions (W x H x D)

Refer to **Figures 3.4.1 Dimensions.**

Machine – 50.5 in. x 54 in. x 85 in.
– (128.25 cm. x 137 cm. x 216 cm)
– 105” long with delivery table

3.5 Electrical requirements



INFORMATION: Refer to the serial plate located on the rear of the laminator for specific electrical ratings applicable to the unit.

Voltage – 230VAC ~ 60Hz
Current – 42A (50 Amp Circuit Breaker)
Power – 9660 W
Wall Receptacle – NEMA 6-50R

3.6 Recommended Work Area

The Polaris should have a working area of 12 ft X 16 ft for ease of operation and safety purposes.

Figure 3.4.1 Dimensions

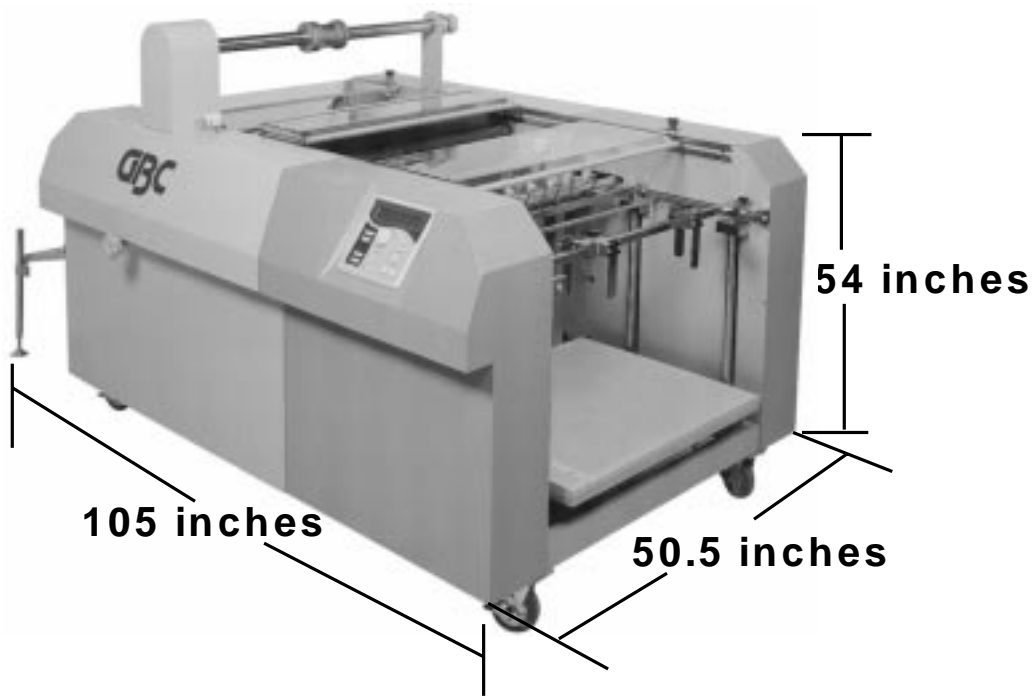

4.0 Installation

GBC Films Group is committed to a program of ongoing product improvement. As a result, we are providing these instructions so you can insure that your new Polaris Laminator is properly and securely unpacked, moved, and installed.

Before the Polaris Laminator can be installed, there are a few requirements that must be met. Make certain that each of the requirements listed in the following pre-installation checklist are met before beginning installation.

4.1 Pre-installation

- Are doorways and hallways wide enough for the laminator to be moved to the installation site?
- Is there ample room for the laminator?
- A work area must be established that allows for operation in both the front and rear of the laminator and provides space for efficient material flow.
- Is the environment appropriate for the laminator? The laminator requires a clean, dust and vapor free environment to operate properly. It must not be located where there is air blowing directly on the machine.
- Have you contacted a certified electrician to both wire the laminator and ensure that adequate power is being supplied, having the appropriate capacity, over current protection and safety lockouts are available?



CAUTION: Too high or too low of an operating position can lead to serious bodily injury and/ or cause poor output quality.

1. All support feet should be positioned completely on the supporting surface.



CAUTION: The laminator is a heavy piece of equipment and may cause injury and/ or require extensive repair work if it falls.

The supporting surface may also be strong enough to hold the material being laminated.

2. The supporting surface should be large enough to support the feed table and catch table comfortably.

3. Avoid locating the laminator near sources of heat or cold. Avoid positioning the laminator in the direct path of forced heated or cooling air.



INFORMATION: This effects the performance of the heating system and could result in poor output quality.

4.2 Setting up your laminator

After placing your Polaris laminator, the catch table must be installed.

1. To assist in the installation of the catch table, a set of tools has been provided. The tools are sent with the machine and can be found wrapped up on the front feed table.

2. Locate rear feed table and inspect for any damages that may have been caused during shipping. Locate Four bolts, two C-clamps, two flat mounting plates, two legs, and four nuts.

3. Place the table leg between the C-clamp and the flat mounting plate. Secure the legs to the table using bolts and nuts. **NOTE:** These legs may have been pre-assembled at the factory.

4. At this time the feed table legs can be adjusted to desired height (approx 16"). Table height (angle) depends on the paper stock being laminated. Tighten nuts.

5. After the feed table is set to desired height, mount the table on the machine using the front table hooks. To apply the rear catch table, first locate the catch table support bar located at the rear of the machine. The catch table hooks directly to the catch table support bar

6. At this time the paper guides can be mounted onto the catch table. **See Figure 4.2.1.**

Figure 4.2.1 Paper Guide

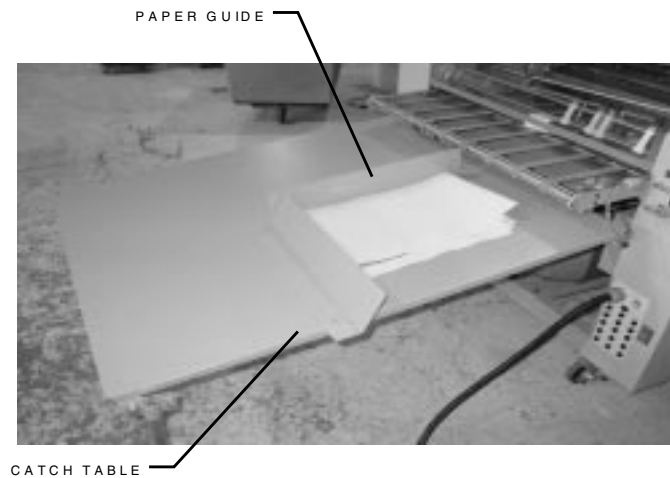

Once the catch table is in place, connect the air/ vacuum pump (rated 230V @ 10 Amps or less) to the receptacle located under the separator. The receptacle is identified by the label shown below.

Refer to Section 3.5 Electrical requirements



5.0 Operation

This section covers the components of the laminator, the control panel, feed table, supply shaft, knife assembly film alignment and tension knobs.

5.1 Components on the laminator

(1) **POWER ON/OFF:** This is located to the lower right of the catch table. When set to the “I” position, applies power to the laminator. When set to the “O” position, removes power from the laminator. See Figure 5.1.1.

Figure 5.1.1 Power Switch



(2) **FEEDER :** The feeder is completely automatic in operation. After set up, minor pile height adjustments will be necessary for changes in pile characteristics.



INFORMATION: The feed table will only allow one sheet to enter the machine at a time. The Polaris will accommodate an 17 inch pile height.

(3) **TABLE SIDE GUIDE:** The side guides are adjustable to ensure accurate feeding. The Polaris is left justified. All settings should be set from left to right. See Figure 5.1.2.

CAUTION: The feed guide should be set outside the width of the film. The film should be completely inside the sheet being fed.

(4) **SUCTION CUPS:** The Feed Table works with a series of suction cups. The suction cup bar can be adjusted to allow operator to increase or decrease suction. See Figure 5.1.2.

(5) **PILE BLOWER:** There are a series of air blow holes located on a support bar for the infeed plate, which blows air into the sheet pile. This helps in the separation of sheets and allows one sheet to be fed into the machine at a time. See Figure 5.1.2.

(6) **PILE HEIGHT SENSORS:** The Pile Height Sensors control the feed table by automatically raising the table as images are being fed into the laminator. This is adjusted by the operator while the machine is running. See Figure 5.1.2.

Figure 5.1.2 Feed Table Details

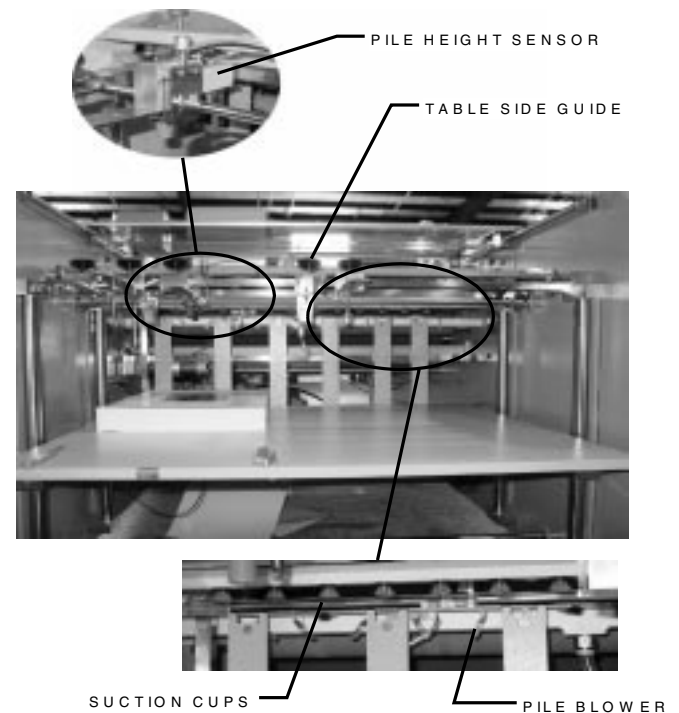

(7) **CATCH TABLE:** The catch table is located at the rear of the machine and collects finished sheets. See **Figure 5.1.3.**

Figure 5.1.3 Catch Table

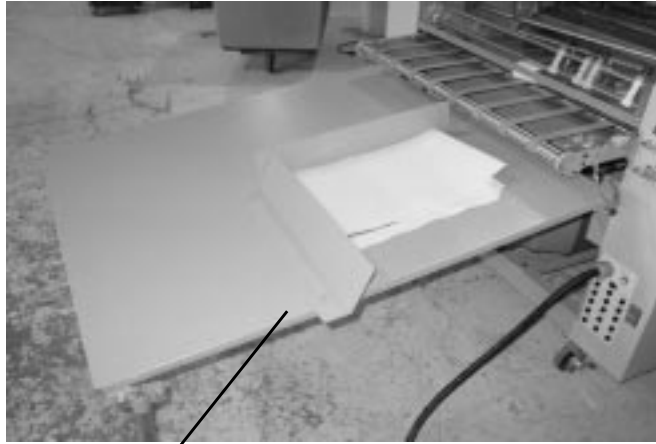

CATCH TABLE

(8) **VACUUM AND BLOWER ADJUSTMENT KNOBS:** The vacuum to the suction cups and the pile blower can be controlled by increasing or decreasing air adjustment knob of your compressor. See **Figure 5.1.4.**

Figure 5.1.4 Vacuum Adjustment



VACUUM AND BLOWER
ADJUSTMENT KNOBS

(9) **AIR GAUGE & REGULATOR AND VACUUM GAUGE:** The air pressure gauge and regulator indicate and control the amount of air being blown into the feeder stack.

The vacuum gauge indicates how much suction is applied to the suction assembly. See **Figure 5.1.5.**

Figure 5.1.5 Air and Vacuum Gauges

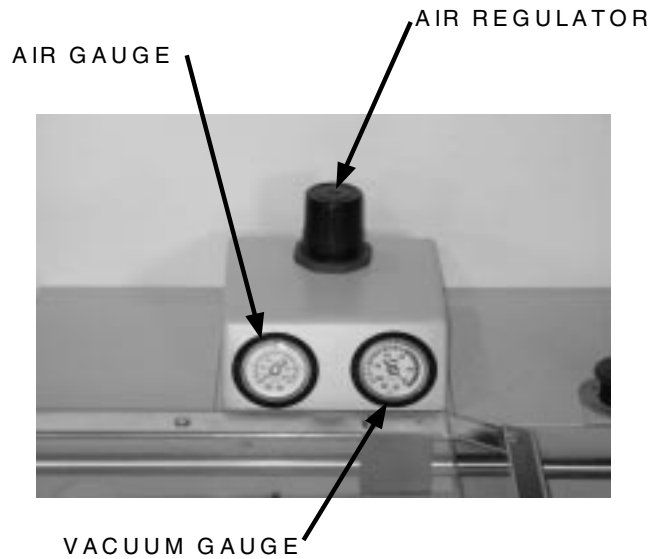

(10) **GUIDE WHEELS:** The guide wheels assist in the entering and exiting of sheets. The guide wheels should be adjusted prior to running a job. Adjustments may have to be made as jobs change. The guide wheels are to be equally spaced to fit on the sheet to be run. See **Figure 5.1.6.**

Figure 5.1.6 Guide Wheels



GUIDE WHEELS

(11) HEAT ROLLER SAFETY SHIELD: Reduces entanglement, entrapment and inadvertent contact with the heat rollers. See **Figure 5.1.7**.



INFORMATION: The Heat Roller Safety Shield is designed to cover the heat roller while machine is running.

To move the main roller safety shield, simply tilt up. The laminator will stop.

(12) HEAT ROLLER: Teflon coated steel tube. Used to heat the laminating film and compress the film to the items being laminated. Heat is provided by 3 internal infrared elements. See **Figure 5.1.7**.

Figure 5.1.7 Heat Roller and Shield

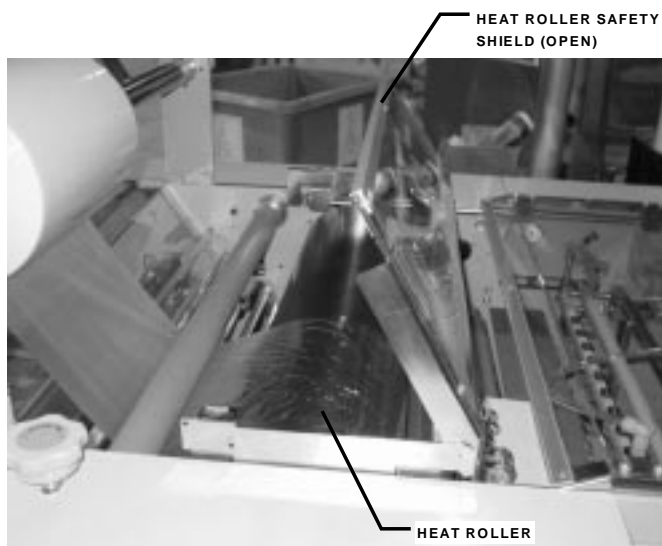

WARNING: Avoid contact with the heat roller. Direct contact with the heat roller can burn you.

(13) PULL ROLLERS: The bottom pull roller, located in the middle of the laminator, is motor driven. When Rollers are in the down position, they simultaneously pull the film and improve the quality of the laminated item. See **Figure 5.1.8**.

(14) FILM TENSION IDLER ROLLER: Located to the rear and next to the Teflon Heated Roller, it directs the film around to the Teflon Roller and has a brake to apply film tension to eliminate film wrinkles. See **Figure 5.1.8**.

(15) DECURLING BAR: The decurling bar is located in the middle of the machine, just past the main rolls. The decurling bar can be adjusted with the decurling bar adjustment knob to ensure a flat output.

(16) KNIFE ASSEMBLY: The knife assembly is located in the back of the machine. The knife automatically cuts and separates the sheets as they are run through the machine. See **Figure 5.1.8**.

(17) KNIFE SEPARATOR SAFETY SHIELD: Reduces entanglement, entrapment and inadvertent contact with the separator knife.

To raise the knife separator safety shield, gently lift. Once the safety latch has been retracted, power to the motor is removed. See **Figure 5.1.8**.

To close the safety shield, gently lower the shield until it is in its closed position. The motor will revert to its condition prior to the safety shield being raised.



INFORMATION: The laminator will operate only when the knife separator, pull roll, decurling bar, film tension idler bar and feeder shields are in their closed position and the safety interlock latch is properly engaged. Power to the motor is removed when any safety shield is in the open position.

Figure 5.1.8 Pull Roll

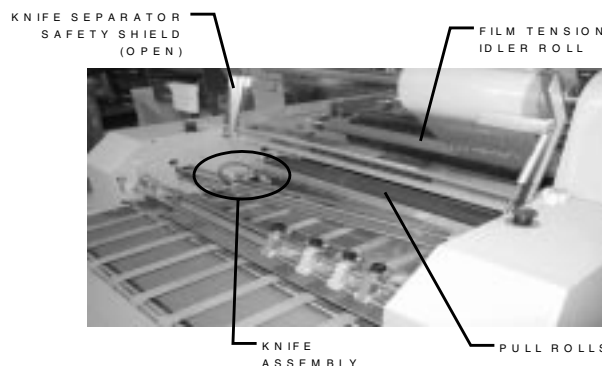

(18) PAPER GUIDE PIN: The paper guide pin allows the operator to raise the finish product up to the knife separator for a smooth feed into the knife separator. See **Figure 5.1.9**.

Figure 5.1.9 Paper Pin

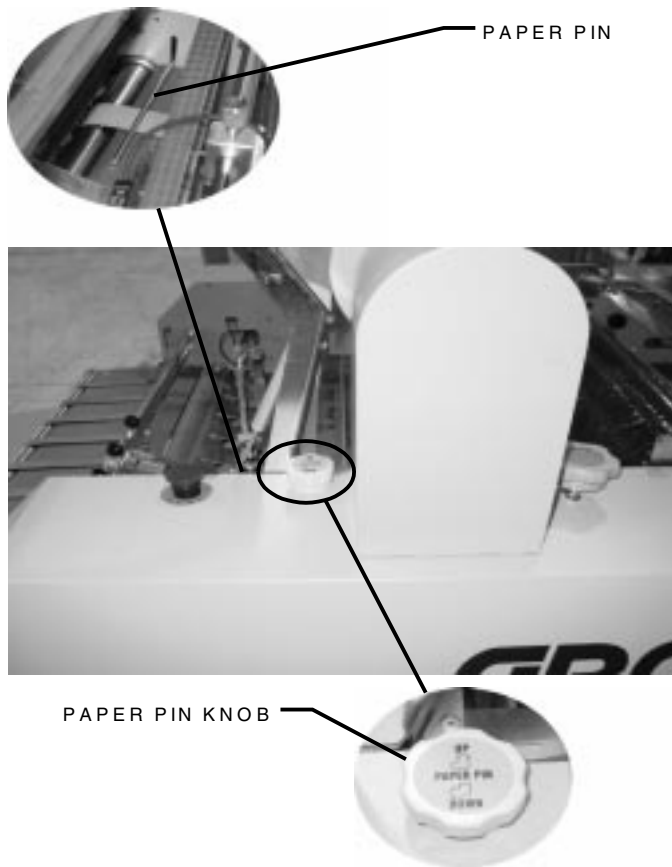

(19) SUPPLY SHAFT: The supply shaft holds the film supply and the core adapters hold the rolls of film on the film shaft.

(20) CORE ADAPTERS: The film shaft holds the supply roll while the core adapters hold the rolls of film on the shaft.

(21) FILM TENSION CONTROL: Allows the operator to increase or decrease film web tension as necessary to reduce curl and wrinkles. Refer to Section 5.2 Film Tension for more information on tension.

(22) EMERGENCY STOPS: The emergency stops are located on top of the laminator. They can be located

by the yellow hazard stickers and should be used to stop the machine in the event of an emergency. The emergency stop removes power from the machine.

(23) NIP POINT: The point at which two rollers come into contact. The nip point of the heat rollers is the place at which the items for lamination are introduced into the laminator.



CAUTION: Only feed acceptable materials through the nip of the rollers. Unacceptable materials may create unsafe conditions.

(24) FILM WEB: Laminating film loaded into the machine

(25) CONTROL PANEL: The control panel is located on the top, control side of the machine.

(26) FILM SUPPORT ARM: Arm used to support the drive side of the air shaft. See **Figure 5.1.10**.

(27) SUPPORT LOCKING PIN KNOB: Located on film support arm. Turn knob to lock air shaft to support arm. See **Figure 5.1.10**.

Figure 5.1.10 Film Support Arm

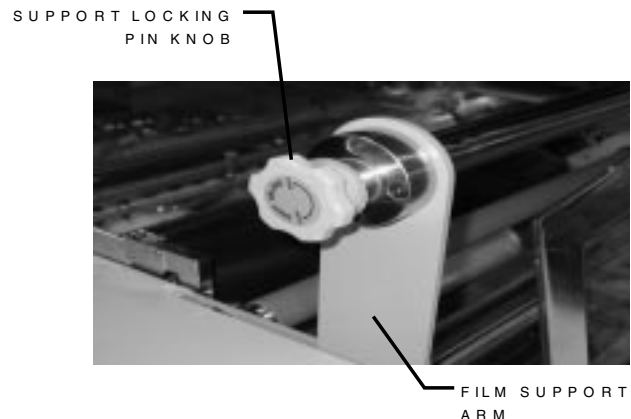

5.2 Control panel

Refer to Figure 5.2.1 Control panel

(1) START/SPEED UP: This button has a dual function. When the machine is stopped and all safety covers are closed, press and hold the START button to begin operation. The feeder head will cycle home while the START button is pressed. Once the feeder head is home, press the START button for 1 second. The nip roller will start to raise and after about 2 seconds, the laminator will start.

Once the laminator is running, pressing the START button again will increase the running speed by 3 ft/min.

(2) STOP: Pressing the STOP button while the laminator is running will stop the laminator. Pressing the STOP button a second time (when machine is stopped) will lower the nip roller. Be sure to lower the nip roller when the job is complete.

(3) DECREASE SPEED: If the laminator is running, pressing this button decreases the speed by 3 ft/min.

(4) BLADE RETURN/INCH: This is a three position switch with two functions. When the switch is in the vertical position, the machine runs normally. Turning the switch to the right (clockwise) and holding will inch the laminator roll forward at 3 ft/min. Turning the switch to the left (counter clockwise) will send the knife to the home position if all covers are closed.

(5) BRAKE PRESSURE ADJUSTMENT: This dial is used to adjust the pressure on the film brake. Turning the dial to the left (counter clockwise) decreases the film tension. Turning the dial to the right (clockwise) increases the film tension.

(6) TOUCH SCREEN: The Touch screen has five operator screens. To navigate through the screens, use the left and right arrow keys displayed on the bottom of each screen. Hitting the arrow keys continuously will wrap the screens around to the beginning. The “Speed” screen is considered the base screen.

Refer to 5.3 Operator Screens for a description of each screen.

Figure 5.2.1 Control panel

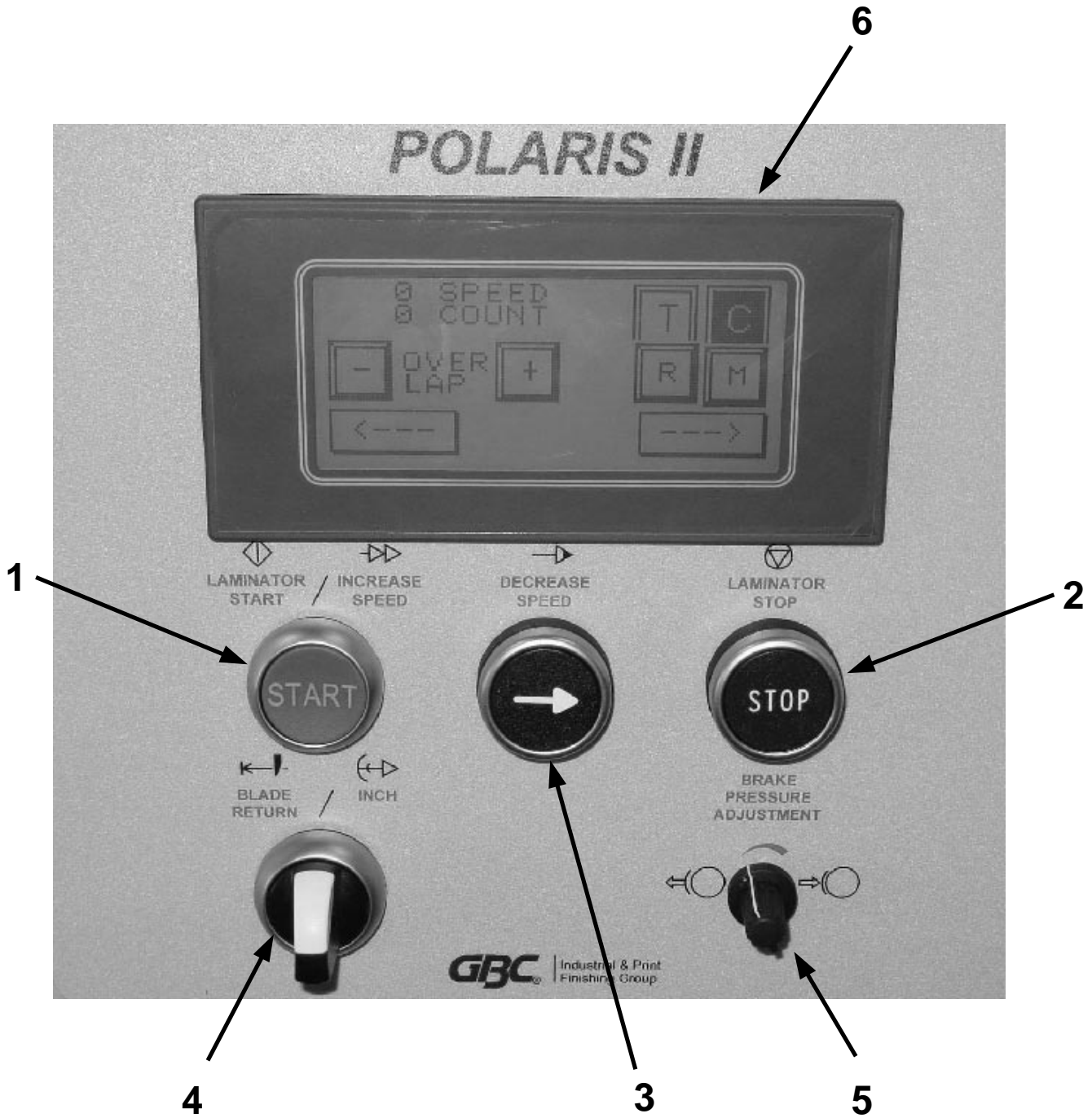

5.3 Operator Screens

The Touch screen has five operator screens. The following is a description of each screen:

SPEED SCREEN

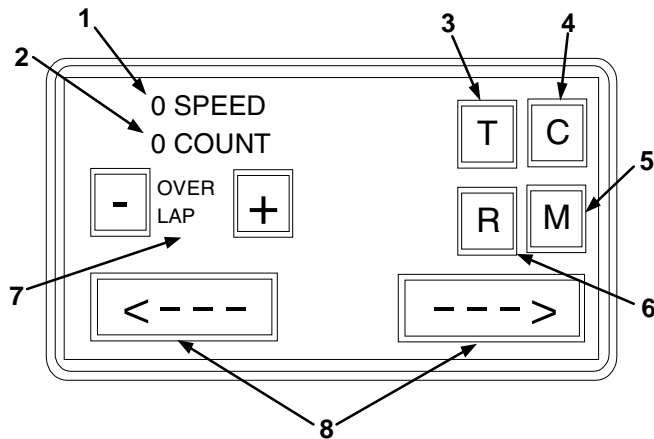

(1) **SPEED:** Displays current speed of machine in ft/min.

(2) **COUNT:** Displays the current job count. The counter increments every time the knife makes a pass over the conveyor while the laminator is running. To reset the counter, press the “R” button on this screen.

(3) **T:** This is a display tool only. When the symbol turns to a black background with a white “T”, the temperature of the lamination roll had reached the set point and laminator is ready to run.

(4) **C:** This is a display tool only. The symbol turns to a black background with a white “C”, when all of the safety covers are closed.

(5) **M:** Misfeed override. When setting up the feeder, the operator may want to override the misfeed sensor. Pressing this button will override the alarm and allow the machine to run while allowing gaps between the sheets. When the button is black with a white “M”, the misfeed sensor is active and will stop the machine when gaps between the sheets are larger than 1/4”. When the button is white with a black “M”, the misfeed sensor is overridden. It is not recommended to laminate while the misfeed sensor is overridden because film may stick to the nip roll and cause a wrap up.

(6) **R:** Reset Counter. This button resets the current job counter to 0.

(7) **OVER LAP +/-:** Pressing the “+” button increases the over lap between sheets while pressing the “-” button decreases the over lap.

(8) **SCREEN NAVIGATION:** The arrow buttons move from one screen to the next. These buttons work the same on all of the operator screens.

MISC SERVICE SCREEN

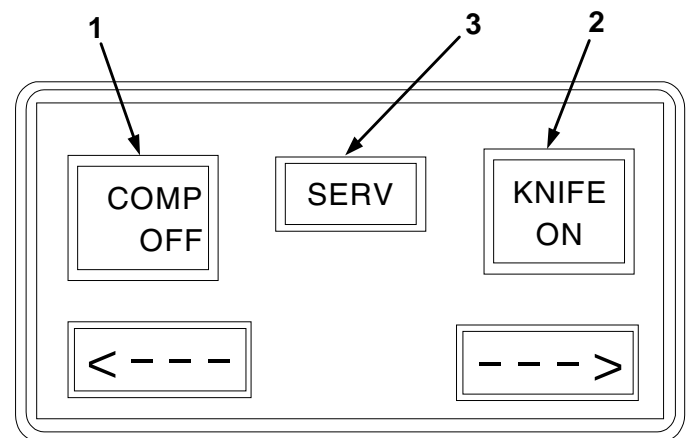

(1) **COMP OFF/COMP ON:** This button toggles the compressor on and off.

(2) **KNIFE ON/KNIFE OFF:** This activates the knife to cut when the over lap sensor is covered. Turning the knife off prevents the knife from activating when the over lap sensor is covered.

(3) **SERV:** These buttons are reserved for GBC Service Technicians.

TEMPERATURE SCREEN

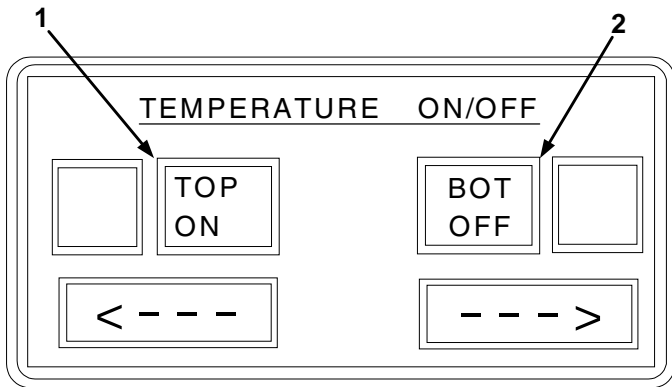

(1) TOP ON/OFF: This button toggles the heater for the top roll on and off. Be sure to go to the PAPER AND FILM screen and select the correct film type for the job running. The symbol to the left of the button indicates when the heater coils are pulsing on (black) and off (white).

(2) BOT ON/OFF: This button toggles the heater for the bottom roll on and off. This heater will only be active when the film type of “HiTac” is selected on the PAPER AND FILM screen. The symbol to the right of the button indicates when the heater coils are pulsing on (black) and off (white)

PAPER AND FILM SCREEN

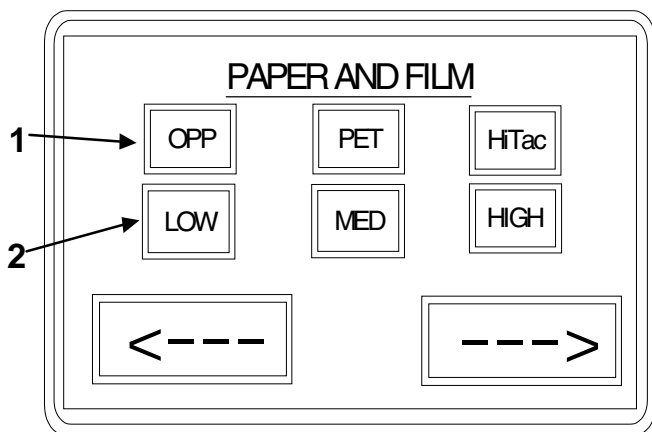

(1) FILM TYPE: Use these buttons to select the film type that is loaded. This is important in that this is what sets the temperature set point for the lamination roll.

(2) PAPER WEIGHT: Use these buttons to select the nip pressure for the machine. Almost all paper stock can be run at HIGH pressure. If you experience wrinkles in the paper, stop the machine and select a lower pressure. You can not adjust the nip pressure while the machine is running.

PILE TABLE SCREEN

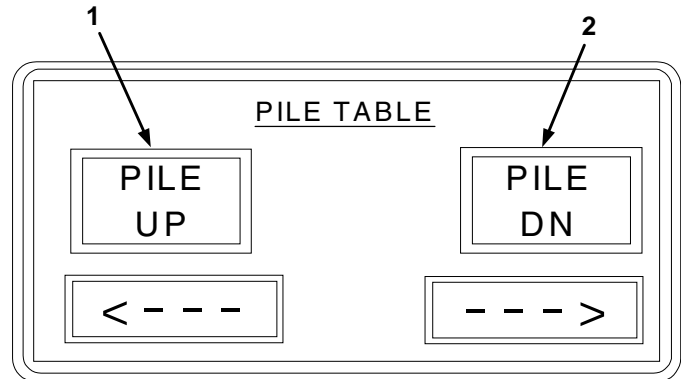

(1) PILE UP: Continually pressing the PILE UP button brings the paper pile up. This button is only active when the laminator is stopped. The table will automatically stop when you release the button, the pile up sensor is activated, or the top limit switch is activated.

(2) PILE DN: Pressing and releasing the PILE DN button will send the pile down until the PILE DN button is pressed again or the pile down limit switch is activated. The operator can also stop the pile down by placing their hand under the pile height sensor for 1 second.

ALARM SCREENS

There are a number of alarm screens that appear if there is a problem with the laminator. The following is a list of these screens:

MISFEED - This alarm is indicated when the misfeed sensor is activated and the laminator will stop. Press ACCEPT to acknowledge the alarm.

KNIFE JAM - When the knife does not travel from home to the return sensor within 3 seconds, the knife jam

alarm will activate and the laminator will stop.

TOP HEAT SENSOR BLOCKED - When the top heat sensor is blocked for more than 5 seconds, this alarm will activate. When the alarm is displayed, the heat automatically shuts off and must be manually reset.

BOTTOM HEAT SENSOR BLOCKED - When the bottom heat sensor is blocked for more than 5 seconds, this alarm will activate. When the alarm is displayed, the heat automatically shuts off and must be manually reset.

COVER ALARMS - There are 5 cover alarms. Feeder Cover, Laminator Cover, Draw Cover, Cutter Cover and Tension Roller. When the start button is pressed with a cover open, this alarm will activate. The operator can either accept the alarm or close the cover.

E-STOP ALARM - When the start button is pressed with an E-STOP button activated, this alarm will display. Reset the E-STOP to continue operation.

5.4 Supply Shaft

To remove film

- 1.. Release any tension from the supply shaft.
2. Unscrew the Support Locking Pin Knob until the Film Supply Shaft is free.
3. Gently lower the film support arm.
4. Loosen and remove core chuck end.
5. Remove film at this time.

To replace

1. Slide the film over the supply shaft adhesive side away from the roller.
2. Tighten core ends to secure film on supply shaft.
3. Raise the film support arm.

4. Screw in the Support Locking Pin Knob until the locking pin is secured into the film supply shaft.

5. Spin roll to insure smooth rotation.

5.5 Separator Knife:

The integrated sheet separator is able to run with continuous web flow for high production output. The precision knife separates sheets while lamination web is moving.



INFORMATION: The laminator will operate only when the knife separator, pull roll, decurling bar, film tension roller and feeder shields are in their closed position and the safety interlock latch is properly engaged. Power to the motor is removed when any safety shield is in the open position.

5.6 Film Alignment

The Polaris laminator is a left justified machine. Film should be aligned from the left going to the right. Film should not be centered on the supply shaft.

5.7 Film Tension

On the Operator Control Panel, use the Film Tension Knob to adjust the amount of brake tension applied to the Film Idler Roller. Clockwise will increase the brake. Counter-clockwise will decrease the brake. Refer to Section 5.2 Control Panel for information on setting the film tension.

If the Film Idler Roller is not providing enough film tension, additional tension can be set using the manual tension knob on the supply shaft. See **Figure 5.7.1**.

Figure 5.7.1 Manual Tension Knob

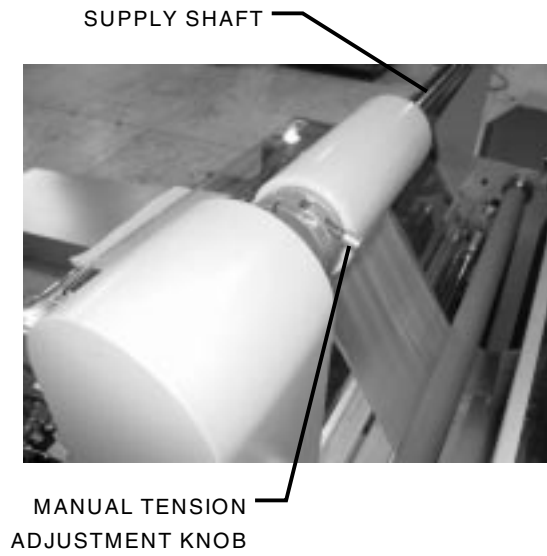

6.0 Applications

The Polaris will accommodate rolls of film on a 3 inch core. This section will describe how to load and thread film and start an application. This section will also give some helpful hints and important points to remember.



WARNING: Do not wear ties, loose fitting clothes or dangling jewelry while operating or servicing the laminator. These items may get caught in the nip and choke you or you can be crushed or burned.

6.1 Film loading and threading

- (1) Turn power ON.
 - (2) Slide the roll of laminating film onto the unwind shaft so the adhesive is facing away from the heat roller when placed on the laminator.
- CAUTION:** The dull side of the film contains the adhesive. Use extreme caution when loading delustered (matte) film as both sides appear dull.
- (3) Load the sheet stack on the feed table. Make sure to “fan” the paper when loading to ensure proper feeding. Left justify the paper and adjust paper guides as required.

- (4) Adjust suction cups on the feeder so that only the suction cups needed are being used. To adjust, turn off the first suction cup that does not come in contact with the paper stack. See **Figures 6.1.1 and 6.1.2**

Figure 6.1.1 Suction Cup Control

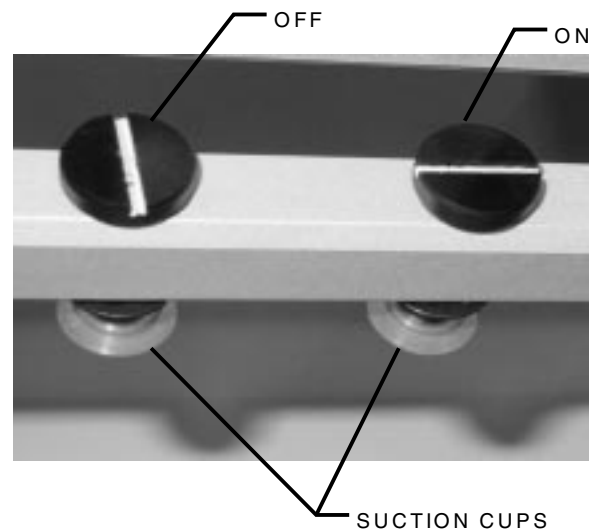
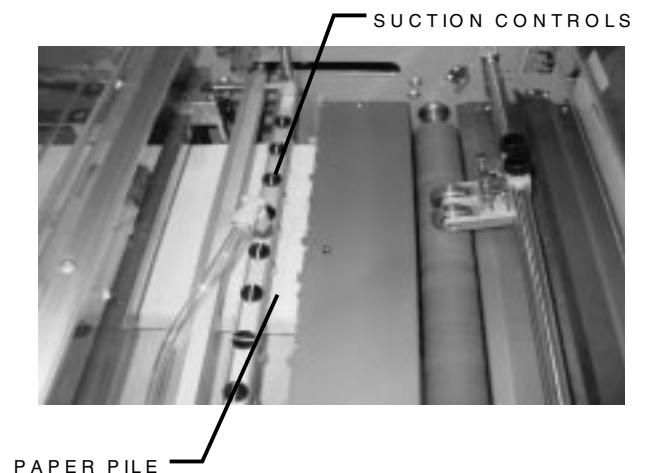

Figure 6.1.2 Suction Cups and Paper Pile



- (5) Adjust suction cup pressure and blower pressure. As a starting point, the blower should be set at 20 Kpa and the suction should be set to -40 Kpa. This may have to be adjusted for different applications.

- (6) Select paper length on main control panel.

- (7) Select Nip Pressure on main control panel. See “Application Guide” for settings.

- (8) The Polaris is left justified and the film should be lined up from the left to the right. Once the film is mounted, secure in place by tightening the screws on the locking collars.

(9) The cutter On/Off indicator is to be off during the webbing process.



WARNING: Roller are **HOT**. Use extreme caution when loading film. Direct contact with the rollers can burn you!

(10) Lift the main roller safety shield for ease of webbing the film.

(11) Pull the laminating film down under the rubber idler, and over the heat roller and allow film to drape down freely.

(12) Adhere a threading card (a piece of heavy stock paper, card board, or similar product) to the film to help guide the film through the nip. See **Figure 6.1.3**.

CAUTION: The threading card should exceed the width of the film to prevent activated adhesives from adhering to the bottom roller.

(13) Slide the threading card between the nip roller and the heat roller. Push the threading card into the nip of the main rollers and through the main rollers.

(14) Guide the threading card under the idler roller in front of the decurling bar, then over the decurling bar.

(15) Guide the threading card through the pull rolls. See **Figure 6.1.3**.

(16) Lower the pull roller with the pull roller knob.

(17) Insert another sheet into the nip of the main roller and the nip roller.

(18) Close all guards.

(19) Home the knife by pressing Cutter ON/OFF.



CAUTION: Ensure the safety shields are in the fully closed position.

Figure 6.1.3 Film Leader

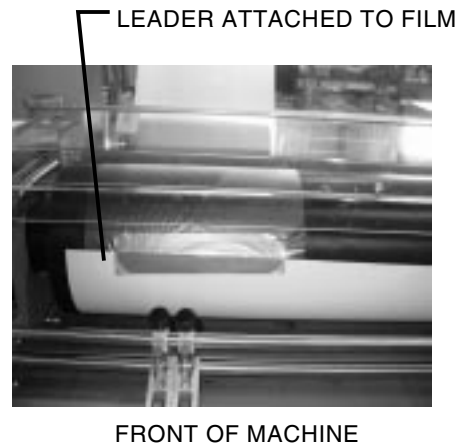

(20) Press Start.

(21) Press Cutter ON/OFF to turn off the knife.



INFORMATION: When Start is pressed, the machine will have a short pause. This allows the operator to walk to the rear of the machine to help guide the threading card through the machine.

(22) After the second sheet passes through the nip, the automatic feed table will feed the nextsheet on the stack. As the secondsheet travels through the nip, it passes a paper sensor. When the paper passes the sensor, it allows the nextsheet to be laminated to enter the laminator. This feature allows the feeder to automatically set an overlap.

(23) After a web of film and paper are running through the laminator, turn the knife on by pressing Cutter ON/OFF.

(24) At this time adjustments can be made such as speed, film tension, air pressures and decurl.

CAUTION: Anything obstructing the path of the film exiting the rear of the laminator may cause a film jam (wrap-up).



INFORMATION: The roll guard is to be closed over the heat roller when running this machine.

(25) Before the last laminated item has completely cleared the nip rollers, press Stop. This prevents adhesive from getting on the rolls.

(26) Turn the laminator off by pushing On/Off to the “O” position.



INFORMATION: You do not need to un-web the laminator after turning power off except to clean the rollers. Refer to Section 7.2 Cleaning the Rollers.

6.2 Helpful hints

Good consistent lamination is a result of combining proper heat, speed, tension, and dwell time. Dwell time is the amount of time the material to be laminated is compressed between the heat rollers. The longer the dwell time, the more the adhesive will liquify. The result is a better bond.

If you are ever unsure that your laminator is set at the proper setting, run a test piece (scrap) of the same or similar material through the laminator.

Always use the minimum brake tension necessary to

achieve the desired results. Using the maximum amount will yield unwanted results after close inspection. You may see stretching, waves in the laminate, distortion of the image and/or curling.

For more helpful hints, please refer to the “*Quick Reference Guide*” included at the end of this section. This guide can be copied and posted next to the machine for reference.

6.3 Important points to remember

CAUTION: Do not press RUN until READY has illuminated.

CAUTION: To cut film or web, only use an enclosed blade around the laminator. DO NOT cut directly on the teflon or nip rollers.

CAUTION: Do not force items into the laminator. An item that is not easily drawn into the laminator is probably too thick to laminate.

CAUTION: Do not attempt to laminate abrasive or metal objects such as staples, paper clips, or glitter as they may damage the heat rollers.



WARNING: Do not attempt to laminate adhesives marked “FLAMMABLE”



CAUTION: Avoid direct contact with the heat rollers when changing the supply roll after the laminator has been running.

CAUTION: Do not stop the laminator before an item has completely exited the pull rollers. Even a momentary stop will cause a dwell line (heat line) on the laminated item.



INFORMATION: Wrinkles may result if an attempt is made to reposition an item once it has entered the nip of the heat rollers.



INFORMATION: Wrinkles may result if an attempt is made to reposition an item once it has entered the nip of the heat rollers.



INFORMATION: When feeding long items, Skewing may occur if the item is not fed into the laminator straight. Use the feed guide and guide wheels to help prevent this from happening.



INFORMATION: If the machine is not working, always check if the safety shield is closed, emergency stops are not engaged, or fuses have not blown, before placing a service call.

Quick Setup

1. Place sheets in feeder with the grain parallel with the Nip.
2. Be sure that the pile is flat within 1/8”.
3. Move feeder up and stop the pile 1” from the infeed plate.
4. Adjust back and side guides.
5. Move pile up until top sheet is 1/8” from infeed plate.
6. Set pile sensor.
7. Turn compressor on and regulate until top sheet floats up to the infeed table.
8. Turn vacuum cups on or off according to the sheet width.
9. Set the sheet length, nip pressure and heat temperature for the application. (See “Application Guide” later in this section.)
10. Test feed sheets through the nip without film or heat. Adjust as necessary.
11. Web film and turn on heat to correct temperature.
12. Bring knife out of the paper path.
13. Start machine and run 4-5 sheets without cutting.
14. Adjust film location if needed. Film should be 1/4” from the edge of sheet.
15. Set up exit wheels. One on each edge of sheet and two in middle.
16. Set up knife return sensor 5” from edge of sheet.
17. Bring knife into paper path.
18. Start machine with knife on.
19. Make adjustments according to “Operation Tips” to follow.

Operation Tips**Feeding:**

- Keep the top of the pile 1/8” from the infeed plate by using wooden wedges.
- Keep the front of the pile flat within 1/8”.
- Place 10-15 sheets of scrap paper on top of the job for setup and start.
- Place 1” of scrap paper under the job to insure all sheets are fed.
- Supply only enough air to the paper stack to float sheets up to the infeed plate.

Laminating:

- Run paper with the grain parallel to the nip to avoid side curl.
- Set temperature of heat roll according to the “Application Guide”
- Set nip pressure according to the “Application Guide”.
- To remove silvering, increase heat or nip pressure.
- All HI-TAC films must run 21 ft/min for best quality.
- If paper has curl in one corner, shift paper and film to the middle of the laminator.

Cutting:

- Place the first wheel half way on the edge of the sheet at a slight inward angle.
- Place the last wheel fully on the far edge of the sheet at a slight inward angle.
- Place the two inner wheels straight with no pressure on the springs.
- Adjust springs on the outer wheels to achieve a flat sheet.
- Run lamination 3/8” from the edge of the paper for better knife engagement.
- Run paper with 1/4” overlap.
- Use the paper pick for lighter sheets.
- Flat sheets will cut better than curled sheets.

Application Guide

The following chart is intended to be used as a guide to set up the machine for different applications. These are starting points for the setup process. Factors such as humidity and media/film quality can effect the final setting to obtain the best quality.

HiTac Films For Digital Printers

Media	Top Roll Temp	Machine Settings		Nip Pressure	Speed
		Bot. Roll On/Off			
24lb Bond (75 gms)	290 Deg. F	ON		Heavy	21 ft/min
80lb Cover (218 gms)	290 Deg. F	ON		Medium	21 ft/min
90lb Cover (244 gms)	290 Deg. F	ON		Medium	21 ft/min

OPP Films for Offset Presses

Media	Top Roll Temp	Machine Settings		Nip Pressure	Speed
		Bot. Roll On/Off			
24lb Bond (75 gms)	225 Deg. F	OFF		Heavy	27 ft/min
80lb Cover (218 gms)	225 Deg. F	OFF		Medium	40 ft/min
90lb Cover (244 gms)	240 Deg. F	OFF		Medium	50 ft/min

LayFlat Films for Offset Presses

Media	Top Roll Temp	Machine Settings		Nip Pressure	Speed
		Bot. Roll On/Off			
24lb Bond (75 gms)	240 Deg. F	OFF		Heavy	27 ft/min
80lb Cover (218 gms)	250 Deg. F	OFF		Medium	40 ft/min
90lb Cover (244 gms)	260 Deg. F	OFF		Medium	50 ft/min

PET Films for Offset Presses

Media	Top Roll Temp	Machine Settings		Nip Pressure	Speed
		Bot. Roll On/Off			
24lb Bond (75 gms)	240 Deg. F	OFF		Heavy	27 ft/min
80lb Cover (218 gms)	250 Deg. F	OFF		Medium	40 ft/min
90lb Cover (244 gms)	260 Deg. F	OFF		Medium	50 ft/min

7.0 Maintenance & Troubleshooting

General Binding Corporation laminators require minimal maintenance. However, regular maintenance is essential to keep any piece of precision machinery at peak performance. A maintenance schedule and a section of procedures are included in this section.



WARNING: Do not wear ties, loose fitting clothes or dangling jewelry while operating or servicing the laminator. These items can get caught in the nip and choke you or you can be crushed or burned.



INFORMATION: Improper maintenance can result in poor output quality.

General Binding Corporation offers Cleaning kits (P/N 1711515) as well as Extended Maintenance Agreements.

The only maintenance required by the operator is to maintain clean and adhesive free nip rollers and overall cleanliness of the laminator itself.



ELECTRICAL HAZARD: Do not use liquid or aerosol cleaners on the laminator. Do not spill liquid of any kind on the laminator. You can be severely shocked, killed or cause a fire. Use only a damp cloth for cleaning unless other wise specified.

7.1 Cabinets and cover



ELECTRICAL HAZARD: Remove power from the laminator before cleaning. You can be severely shocked, killed or cause a fire.

Use a damp (use water only to dampen the cloth) white terry cloth towel to wipe dust from the cabinets and cover.

7.2 Clean the rollers



CAUTION: This procedure is performed while the laminator is HOT! Use extreme caution. Direct contact with the rollers can burn you!

CAUTION: Hardened adhesive deposits on the rollers can cause damage to the rollers.

CAUTION: Do not apply cleaning fluids or solvents to the rollers! Fluids and solvents will have a direct effect on the rubber coated rollers and will require replacement.

CAUTION: Do not use metal scouring pads to clean the rollers! Scouring pads will damage the rollers and require replacement.

CAUTION: Never clean the rollers with sharp or pointed objects.

1. Remove the film from the laminator.
2. Preheat the laminator to 240 deg. F.
3. Rub the top and bottom heat rollers with a clean, lint free cloth and mineral spirits.
4. Use the “Inching” function to rotate the heat rollers to a new area for cleaning. Continue this process until the complete surface of both rollers are clean.
5. Use a damp cloth to clean the teflon roller.

7.3 Misc maintenance

- Clean and lubricate chains with standard chain lubricant four times per year.
- Lubricate the gear reducers once a year with standard grease.
- Inspect and replace the suction cups as needed.
- Follow the recommended maintenance for the Becker air pump, as provided in the Becker instruction sheet.

7.4 Troubleshooting

As an operator, you can perform some basic troubleshooting before contacting your local service representative.



WARNING: Never remove the side panels in attempt to troubleshoot the laminator. You may cause damage to other components or injury to yourself.



WARNING HAZARD: Do not open the side panels. You will be exposed to dangerous voltage which can shock.



CAUTION: Only trained technicians should perform service related work on the laminator.

Refer to **Figure 7.3.1 Troubleshooting Guide** on page 7-3.

Figure 7.3.1 Troubleshooting guide

Symptom	Solution
Laminator won't run.	Verify that unit is plugged in and power is present. Check control panel for machine status. Check fuses. Feed pile light must be on.
Feeder not picking up sheets.	Check pick up heads. Check suction at pick up heads. Check air blast. Check pile height proximity switch. Insure that paper is properly stacked and fanned.
Feeder head not moving.	Check fuse. Verify sheet feed eye (1st eye) is clean.
Sheets not feeding straight.	Check Pile Height pinching leading edge under tray Check for uneven pressure on in-feed rollers. Check side guides on table. Check for obstructions on in-feed plate. Check Air Blast
Sheets wrinkled.	Film tension not set properly. Adhesive or paper on rollers. Roller pressure uneven. Crooked infeed. Pull out roller pressure uneven.
Film stretching or shrinking.	Speed too slow. Film tension too high. Film tension too high on core chuck. Binding of core chuck on shaft.
Film not sticking.	Machine not up to heat. Running too fast. Nip roller pressure not set properly. Using incorrect film.
Excessive upward curl.	Brake or film tension set too high. Decurling bar not set properly.
Excessive downward curl.	Decurling bar not set properly.
Cutter not cutting.	Cutter not in home position. Check fuse. Cutter and detector out of alignment with film web. Film web to close too edge of paper. Web running over blade. Overlap too small Use paper pin
Sheets not exiting the back of the machine.	Check fuse. Pressure on pull out rollers not set properly. Obstructions in cutter area. Use exit clips. Sheet not flat.

