

1.0 Guardian Installation/Operating Procedures

IMPORTANT SAFETY INSTRUCTIONS

Your safety as well as the safety of others is important to GBC. In this instruction manual and on the product are important safety messages. Read these messages carefully.



 The safety alert symbol precedes each safety message in this instruction manual and on the product. This symbol indicates a potential personal safety hazard that could hurt you or others, as well as cause product or property damage. The following warning is found on the bottom of the product.

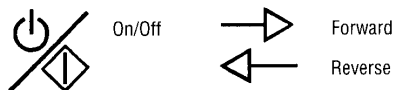

This safety message means that you could be seriously hurt or killed if you open the product and expose yourself to hazardous voltage.

The following ISO and IEC symbols appear on this product, and their meanings are as follows:



-  This means you should be careful because long hair can become entangled in the cutting head. This could hurt you.
-  This means don't reach into the feed opening of the cutting head. This could hurt you.
-  This means be careful of ties and other loose clothing which could become entangled in the

cutting head. This could hurt you.

-  This means you should be careful of loose jewelry which could become entangled in the cutting head. This could hurt you.

ELECTRICAL SAFEGUARDS

- Unplug your shredder before moving it or when it is not in use for an extended period of time.
- Do not operate with a damaged power supply cord or plug, after it malfunctions, or after it has been damaged in any manner.
- Do not overload electrical outlets beyond capacity as this can result in fire or electrical shock.
- The socket-outlet shall be installed near the equipment and shall be easily accessible.
- Do not alter attachment plug. Plug configured for the appropriate electrical supply.

SERVICE

Do not attempt to service or repair the unit yourself. In the U.S. and Canada, if your shredder is under warranty return it to the point of purchase for replacement or repair. If your shredder is no longer under warranty, call (800) 790-7787 for service information. In other countries, contact an authorized GBC service representative for any required repairs.

SPECIFICATIONS

Electrical:	115V/60Hz
Throat Width:	8-3/4"
Shred Width:	5/32" x 1-1/2"
Sheet Capacity:	3-4 sheets/20# bond
Speed:	8 Feet/Minute
Amperage:	1.1 Amps
Duty Cycle:	2/30 Min (ON/OFF)

INSTALLATION

This shredder can be used on a desktop or mounted to a wall. Use the screws provided if a wall mount is desired. For screw mount installation, use the back of the shredder as a template to mark the hole locations.

NOTE: This shredder includes a safety interlock. If the drawer is not completely closed the interlock will not activate and the shredder will not operate.

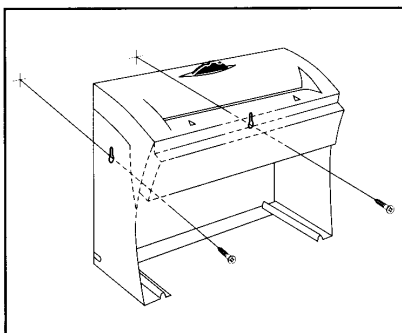

MATERIALS YOU CAN SHRED

Your shredder will handle most any type of office paper documents. You can safely shred documents containing staples, however, other metal items may damage the shredder.

ON/AUTO

Simply insert paper into the center of the throat. Once your document has activated the trigger switch, the unit will turn on and off automatically.

FORWARD AND REVERSE

Moving the switch to either of these positions will cause the unit to run in the corresponding direction.

CLEARING JAMS

If a paper jam occurs, switch the unit to the reverse position until the paper is out of the throat. In some cases, it may be necessary to alternate between FORWARD and REVERSE positions several times to help clear excess paper from the cutting area.

THERMAL CUT-OFF FEATURE

This shredder is designed for low volume shredding, and is not intended for continuous operation. This unit features a thermal cut-off device that automatically shuts off the shredder if run for an extended period of time. If this occurs, simply allow the shredder to cool for 30 minutes before resuming operation.