

**GBC 3064WF**  
**INSTALLATION & OPERATING MANUAL**  
**Part Number: 930-131, Rev A.**



<b>ENG</b>	<b>Operating Instructions</b>
<b>F</b>	<b>Mode d'Emploi</b>
<b>E</b>	<b>Instrucciones de Operación</b>

**Part Number: 930-131.REV.10-17-05**

**ENG**

The information in this publication is provided for reference and is believed to be accurate and complete. General Binding Corporation (GBC) is not liable for errors in this publication or for incidental or consequential damage in connection with the furnishing or use of the information in this publication, including, but not limited to, any implied warranty of fitness or merchantability for any particular use.

GBC reserves the right to make changes to this publication and to the products described in it without notice. All specifications and information concerning products are subject to change without notice. Reference in this publication to information or products protected by copyright or patent does not convey any license under the rights of GBC or others. GBC assumes no liability arising from infringements of patents or any other rights of third parties.

This publication is copyrighted © 2005 by GBC. All rights reserved. The information contained in this publication is proprietary and may not be reproduced, stored, transmitted, or transferred, in whole or in part, in any form without the prior and express written permission of GBC.

**F**

L'information contenue dans cette publication est fournie à titre de référence et elle est considérée exacte et complète. General Binding Corporation (GBC) n'est pas responsable des erreurs contenues dans cette publication ni des dommages indirects ou consécutifs portant sur l'utilisation ou la présentation de l'information de ce document, y compris, mais sans s'y limiter, toute garantie implicite de commercialité ou d'adaptation à un usage particulier.

GBC se réserve le droit d'apporter des modifications à cette publication et aux produits qui y sont décrits sans préavis. Toutes les spécifications et l'information au sujet des produits sont sujettes à changements sans préavis.

Toute référence à l'information ou aux produits protégés par un droit d'auteur ou un brevet présentée dans ce document ne porte aucune licence sous les droits de GBC ou d'autres parties. GBC n'assume aucune responsabilité découlant de contraventions aux brevets ou à tout autre droit de tierces parties.

Cette publication est protégée par un droit d'auteur © 2003 de GBC. Tous droits réservés L'information contenue dans cette publication est privative et ne peut pas être reproduite, mise en mémoire, transmise ou transférée, en partie ou en entier, sous quelque forme que ce soit sans la permission écrite préalable et expresse de GBC.

**E**

La información contenida en esta publicación es proporcionada a título de referencia y se considera que es precisa y completa. General Binding Corporation (GBC) no es responsable por errores contenidos en esta publicación o por daños consecuentes o incidentales relacionados con la disponibilidad o el uso de la información en esta publicación, incluyendo y sin limitarse a, cualquier garantía de aptitud y comerciabilidad para cualquier uso específico.

GBC se reserva el derecho de hacer cambios en esta publicación y a los productos descritos en la misma sin aviso previo. Todas las características y la información referente a los productos, están sujetas a cambios sin aviso previo.

Las referencias en esta publicación a información o productos protegidos por derechos de propiedad intelectual o por patentes no otorga ninguna licencia amparada por los derechos de GBC u otros. GBC no asume ninguna responsabilidad que se derive de la violación de patentes u otros derechos de terceras partes.

Copyright © 2003 Esta publicación está amparada por derechos de propiedad intelectual de GBC. Todos los derechos reservados. La información contenida en este documento es de propiedad exclusiva y no puede reproducirse, almacenarse, transmitirse o transferirse, en su totalidad o en partes, y de ninguna manera, sin la autorización previa y por escrito de GBC.

<b>TABLE OF CONTENTS</b>
--------------------------

Description	Page No.	Description	Page No.
<b>Cover</b>	<b>1</b>	<b>Sequence of Operations</b>	<b>14</b>
<b>Legal Disclaimer</b>	<b>2</b>		
<b>Table of Contents</b>	<b>3</b>	<b>Operating Instructions</b>	<b>15</b>
<b>Important Safety Instructions</b>	<b>4</b>	Film Loading and Threading	<b>15</b>
<b>Important Safeguards</b>	<b>4</b>	Load a Roll of Film	<b>15</b>
General		Webbing Thermal Film using	
Electrical		Threading Card	<b>16</b>
Service		Webbing PSA Film / Mount Adhesive	
		Using Threading Card	<b>17</b>
<b>Warranty</b>	<b>4</b>	Start Laminating	<b>18</b>
<b>Specifications</b>	<b>5</b>	Method for Tacking new Film to	
<b>Pre- Installation</b>	<b>5</b>	Existing Film	<b>19</b>
<b>Installation</b>	<b>6</b>	To Unweb The Laminator	<b>19</b>
<b>Control Guide</b>	<b>7</b>	Clearing a Film Jam (Wrap- Up)	<b>20</b>
<b>Power ON/OFF</b>	<b>7</b>		
<b>Control Panel</b>		<b>Applications</b>	<b>21</b>
LCD Display		Tips for Pre-Coating Boards	<b>21</b>
Display Reset Switch	<b>7</b>	Tips for Mounting Pre-Coated Boards	<b>21</b>
Display	<b>7</b>	Tips for Single Sided Lamination	<b>21</b>
Main Switch (TOP Heater)	<b>7</b>	Tips for Creating a Decal	<b>22</b>
Display	<b>7</b>	Tips for Mounting a Decal	<b>22</b>
Main Switch (Bottom Heater)	<b>7</b>	Thermal Encapsulation	<b>22</b>
Fan Switch	<b>7</b>	AccuShield™	<b>23</b>
Main Roller (Up / Down)	<b>7</b>		
Pull Roller (Up / Down)	<b>7</b>	<b>Speed/Temperature Control</b>	<b>24</b>
Laminator main Control Switch	<b>7</b>		
Machine Power On Light	<b>7</b>	<b>The Art of Lamination</b>	<b>24</b>
Laminator Directional Motion	<b>7</b>	Basic Rules	<b>24</b>
Control Switch	<b>7</b>	Film Tension	<b>24</b>
Laminator Speed Control	<b>7</b>	Heat	<b>25</b>
	<b>7</b>	Output	<b>25</b>
<b>Features Guide</b>			
Emergency-Stop Buttons	<b>8</b>	<b>Maintenance</b>	<b>26</b>
Media Tray Table	<b>9</b>		
Rewind Take up	<b>9</b>	<b>Trouble Shooting Guide</b>	<b>27</b>
Swing out Film Unwind Shaft	<b>9</b>		
Unwind / Rewind Combo	<b>9</b>	<b>Service Agreement</b>	<b>27</b>
Rewind Take Up	<b>9</b>		
Removable Chill Idler	<b>10</b>		
Upper Tension Idler	<b>11</b>		
Lower Tension Idler	<b>11</b>		
Pull Rollers	<b>11</b>		
Heated Main Rollers	<b>12</b>		
Table Idler	<b>12</b>		
Main On / Off Switch	<b>12</b>		
Swing around Control	<b>12</b>		
Panel Arm	<b>12</b>		
Control Panel Box	<b>12</b>		
Electric Safety Beam	<b>12</b>		
Nip Pressure Adjustment	<b>13</b>		
Pull roll Lift handle	<b>13</b>		
Main Roller Lift Handle	<b>13</b>		
Pull Role Clutch Adjustment Knob	<b>13</b>		

**IMPORTANT SAFETY INSTRUCTIONS**

YOUR SAFETY AS WELL AS THE SAFETY OF OTHERS IS IMPORTANT TO GBC. IN THIS INSTRUCTION MANUAL AND ON THE PRODUCT, YOU WILL FIND IMPORTANT SAFETY MESSAGES REGARDING THE PRODUCT. READ THESE MESSAGES CAREFULLY. READ ALL OF THE INSTRUCTIONS AND SAVE THESE INSTRUCTIONS FOR LATER USE.

**⚠ THE SAFETY ALERT SYMBOL PRECEDES EACH SAFETY MESSAGE IN THIS INSTRUCTION MANUAL. THE SYMBOL INDICATES A POTENTIAL PERSONAL SAFETY HAZARD TO YOU OR OTHERS. THE FOLLOWING WARNINGS ARE FOUND UPON THIS PRODUCT.**

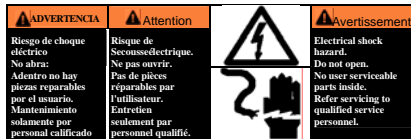

THIS SAFETY MESSAGE MEANS THAT YOU COULD BE SERIOUSLY HURT OR KILLED IF YOU OPEN THE PRODUCT AND EXPOSE YOURSELF TO HAZARDOUS VOLTAGE.



THIS SAFETY MESSAGE MEANS THAT YOU COULD BE BURNED AND YOUR FINGERS COULD BE TRAPPED AND CRUSHED IN THE HOT ROLLERS. CLOTHING, JEWELRY AND LONG HAIR COULD BE CAUGHT IN THE ROLLERS AND PULL YOU INTO THEM.



THIS SAFETY MESSAGE MEANS THAT YOU COULD CUT YOURSELF IF YOU ARE NOT CAREFUL.

**⚠ WARNING: THIS SAFETY ALERT SYMBOL PRECEDES EACH SAFETY MESSAGE IN THIS INSTRUCTION MANUAL. THE SYMBOL INDICATES A POTENTIAL PERSONAL SAFETY HAZARD TO YOU OR OTHERS.**

**⚠ WARNING: DO NOT ATTEMPT TO SERVICE OR REPAIR THE 3064 WF LAMINATOR.**

**⚠ WARNING: DO NOT CONNECT THE LAMINATOR TO AN ELECTRICAL SUPPLY OR ATTEMPT TO OPERATE THE LAMINATOR UNTIL YOU HAVE COMPLETELY READ THESE INSTRUCTIONS. MAINTAIN THESE INSTRUCTIONS IN A CONVENIENT LOCATION FOR FUTURE REFERENCE.**

**IMPORTANT SAFEGUARDS**

**⚠ WARNING: TO GUARD AGAINST INJURY THE FOLLOWING SAFETY PRECAUTIONS MUST BE OBSERVED IN INSTALLATION AND USE OF THE LAMINATOR.**

**General:**

Keep hands, long hair, loose clothing, and articles such as necklaces or ties away from the front of the heat and pull rollers to avoid entanglement and entrapment.

The heat rollers can reach temperatures over 300°F (150°C). Avoid contact with the heat rollers during operation or shortly after power has been removed from the laminator.

Keep hands and fingers away from the path of the sharp film cutter blade located at the film exit.

Do not use the laminator for other than its intended purpose.

Avoid moving the Laminator on uneven floor surfaces. Never tilt the laminator.

Do not defeat or remove electrical and mechanical safety equipment such as interlocks, shields and guards.

Do not insert objects unsuitable for laminating or expose the equipment to liquids.

**Electrical:**

The Laminator should be connected only to a source of power as indicated in these instructions and on the serial plate located on the rear of the laminator. Contact an electrician should the attachment plug provided with the Laminator not match the receptacles at your location.

**⚠ WARNING: THE RECEPTACLE MUST BE LOCATED NEAR THE EQUIPMENT AND EASILY ACCESSIBLE.**

Do not operate the Laminator with a damaged power supply cord or attachment plug, upon occurrence of a malfunction, or if the laminator has been damaged. Contact GBC's Technical Service Department or your dealer/distributor for assistance.

**Service:**

Perform only the routine maintenance procedures referred to in these instructions

**⚠ WARNING: DO NOT ATTEMPT TO SERVICE OR REPAIR THE LAMINATOR**

Disconnect the plug from the receptacle and contact GBC's Technical Department or your dealer/distributor when one or more of the following has occurred.

- The power supply cord or attachment plug is damaged.
- Liquid has been spilled into the laminator.
- The laminator is malfunctioning after being mishandled.
- The laminator does not operate as described in these instructions.

**WARRANTY**

**Limited 90- Day Warranty**

GBC warrants to the original purchaser for a period of ninety days on labor and one year on parts after installation that this laminator is free from defects in workmanship and material under normal use and service. GBC's obligation under this limited warranty is limited to replacement or repair, at GBC's option, of any part found defective by GBC without charge for material or labor.

**THIS LIMITED WARRANTY IS IN LIEU OF ALL OTHER WARRANTIES EXPRESSED OR IMPLIED. WARRANTIES OF MERCHANTABILITY OR FITNESS FOR A PARTICULAR PURPOSE ARE EXPRESSLY EXCLUDED. ANY REPRESENTATIONS OR PROMISES INCONSISTENT WITH, OR IN ADDITION TO, THIS LIMITED WARRANTY ARE UNAUTHORIZED AND SHALL NOT BE BINDING UPON GBC. IN NO EVENT SHALL GBC BE LIABLE FOR ANY SPECIAL, INCIDENTAL, OR CONSEQUENTIAL DAMAGES, WHETHER OR NOT FORESEEABLE.**

This limited warranty shall be void if the laminator has been misused; mishandled; damaged by negligence, by accident, during shipment, or due to exposure to extreme conditions; repaired, altered, moved, or installed by anyone other than GBC or its authorized agents; or if incompatible film was used. GBC's obligation under this limited warranty does not include routine maintenance, cleaning, adjustment, normal cosmetic or mechanical wear, or freight charges.

Without limiting the generality of the previous paragraph, GBC's obligation under this limited warranty does not include:

1. Damage caused to the rollers by knives, razors, or other sharp tools: by any foreign objects falling into the working area of the laminator; or by cleaning the laminator with solutions or materials that harm its surfaces;
2. Damage caused by adhesives; nor
3. Damage caused by lifting, tilting or attempting to position the laminator other than rolling it on its castors across even surfaces.

**FOR EUROPEAN UNION RESIDENTS ONLY:** This guarantee does not affect the legal rights which consumers have under applicable national legislation governing the sale of consumer goods.

**SPECIFICATIONS**

Operating Speed	Up to 20 fpm (5.5 mpm) MAX
Maximum Temperature	300°F (149°C)
Maximum Mounting Thickness	1 in. (25.4 mm) Max.
Maximum Film Width	64 in. (162.5 cm)
Dimensions (W x D x H)	Unit alone: (Uncrated) 86in. x 34.5in. x 57in. (218cm x 88cm x 145cm.) Depth of 3064 WF is 44 in (112 cm) with tables in up position.
Weight	Unit alone: 1500 lbs. (680 Kgs.). Shipping: 1700 lbs. (771 Kgs.).
Electrical Requirements	Refer to the serial plate located on the rear of the laminator for the specific electrical rating applicable to the unit.
Agency Approval	cULus
Voltage	220 V, 60 Hz
Current	32 A
Power	7000 W
Phase	Single
FCC NOTE	<p><b>FCC Class A Notice - Notification pour les Etats-Unis</b></p> <p><b>Note:</b> This equipment has been tested and found to comply with the limits for a Class A digital device, pursuant to part 15 of the FCC rules. These limits are designed to provide reasonable protection against harmful interference when the equipment is operated in a commercial environment. This equipment generates, uses, and can radiated radio frequency energy and, if not installed and used in accordance with the instruction manual, may cause harmful interference to radio communications. Operation of this equipment in a residential area is likely to cause harmful interference in which case the user will be required to correct the interference at his own expense.</p> <p><b>Canada Class A Notice - Avis Canada, Classe A</b></p> <p>This Class A digital apparatus complies with Canadian ICES-003. Cet appareil numérique de la classe A est conforme à la norme NMB-003 du Canada.</p> <p><b>Modifications</b></p> <p>Any modifications made to this device that are not approved by General Binding Corporation may void the authority granted to the user by the FCC and/or by Industry Canada to operate this equipment.</p> <p>Toutes modifications apportées à ce dispositif et non approuvées par General Binding Corporation annuleront le droit accordé à l'utilisateur par le FCC et/ou par Industrie Canada de faire fonctionner cet équipement.</p>

## PRE-INSTALLATION

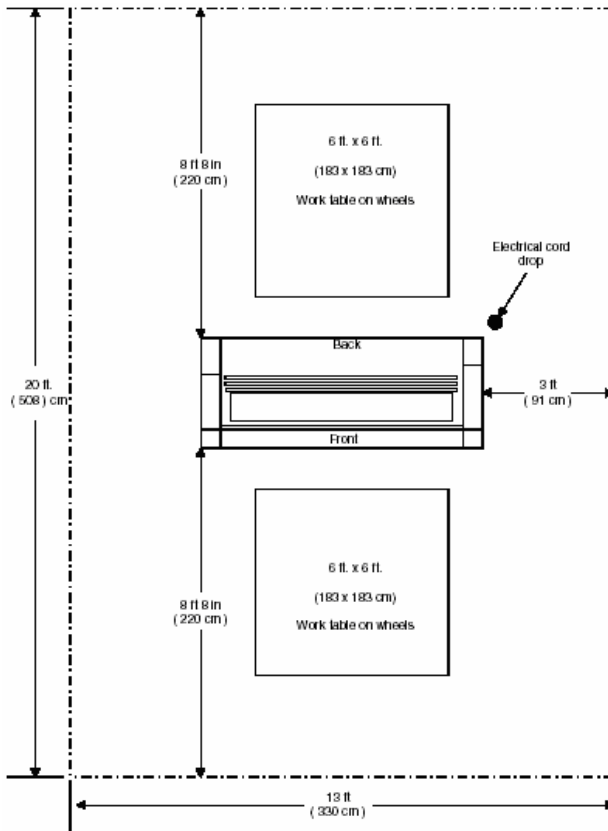

Before a 3064 Laminator can be installed, ensure the following requirements are met:

1. Are doorways and hallways wide enough for the laminator to be moved to the installation site?
2. Is there ample room for the laminator?
  - A work area must be established that allows for operation in both the front and rear of the laminator and provides space for efficient material flow.
3. Is the environment appropriate for the laminator?
  - The laminator requires a clean, dust and vapor free environment to operate properly.
  - Avoid locating the laminator near sources of heat or cold. Avoid locating the laminator in the direct path of forced, heated or cooled air.

**CAUTION: Air flow can cause uneven heating / cooling of the rollers and result in poor output quality.**

4. Have you contacted a certified electrician to wire the receptacle and ensure that adequate power is being supplied, having the appropriate capacity, over current protection and safety lockouts available?

### GBC 3064 WF Requires:

- 220V at 60Hz with 32 amps single phase.
- Nema 6-50 R 50 A 250 V Receptacle

This Machine is supplied with a Nema 6-50 male Plug

## INSTALLATION

1. Shipping damage should be brought to the immediate attention of the delivering carrier.
2. With assistance, carefully roll the laminator into position over flat and even surfaces.
3. The laminator should be positioned to allow exiting film to flow freely to the floor or a work table. Accumulation of laminate immediately behind the laminator as it exits the equipment may cause the film to wrap around the pull rollers, resulting in a "jammed" condition.
4. Avoid locating the laminator near sources of heat or cold. Avoid locating the laminator in the direct path of forced, heated or cooled air.
5. Once the laminator has been properly positioned, lock the castors in place. Locking the castors prevent the machine from rolling during set up, operation or servicing.
6. Connect the attachment plug provided with the laminator to a suitably grounded outlet. Avoid connecting other equipment to the same branch circuit to which the laminator is connected, as this may result in nuisance tripping of circuit breakers or blowing fuses.

**Note:** Machine must be leveled to ensure best performance. Level the machine by lowering both the main and pull rolls. Lay A level on top of the main and pull rolls. Then, check level from main roll to pull roll on right and left side of the roll. Finally, check by placing the level diagonally across lower main to lower pull rolls.

## CONTROL GUIDE



Figure 5

**A. Power ON/OFF (I/O):**

Located at the back left of the machine applies power to the laminator. The control panel display will illuminate when position marked "I" is pushed. The Off position, marked "O" removes power from the laminator.

**B. Control Panel (Figure 5)****1. Main Roll Nip Pressure relevant pressure in percentage:****2. Top Roll Display**

- Displays Temperature in "°C" or "°F" of the Top Heater (Both Set Temperature and Current Temperature)
- LED Marked "°C" if Illuminated indicates reading in "°C"
- LED Marked "°F" if Illuminated indicates Temperature reading in "°F"
- LED Marked "Ready" illuminates when set temperature is reached.

**{a}. Control Switches:**

▲ - When Pressed Increases the Temperature

▼ - When Pressed Decreases the Temperature

MEAS- Press and Hold to Display Current Top Roller Temperature

**3. Main Switch (TOP Heater):**

- ◊ When pressed to the position turns On the top heater, when pressed to the
- ⊗ position turns Off the top heater.

**4. Bottom Roll Display**

- Displays Temperature in "°C" or "°F" of the Bottom Heater (Both set Temperature and Current Temperature when MEAS switch is pressed)
- LED Marked "°C" if Illuminated indicates reading in "°C"
- LED Marked "°F" if Illuminated indicates Temperature reading in "°F"
- LED Marked "Ready" illuminates when set temperature is reached.

MEAS- Press and Hold to Display Current Bottom Roller Temperature

**{b}. Control Switches**

▲ - When Pressed Increases the Temperature

▼ - When Pressed Decreases the Temperature

MEAS- Press and Hold to Display Current Bottom Roller Temperature

**5. Main Switch (Bottom Heater):**

- ◊ position turns On the bottom heater, when pressed to the
- ⊗ position turns Off the bottom heater.

**6. Fan Switch:****7. Laminator Main Control Switch:**

Switches the laminator between "RUN" ◊ and "STOP" ⊗ modes.

**8. Machine Power On Light:**

⊗ Green light illuminated – Machine On.

**9. Laminator Direction Motion Control Switch:**

Controls the forward and rearward movement of the laminator.

**10. Laminator Speed Control:**

Regulates the speed of laminator feed.

- Outer Scale in Feet/Minute.

**FEATURES GUIDE**

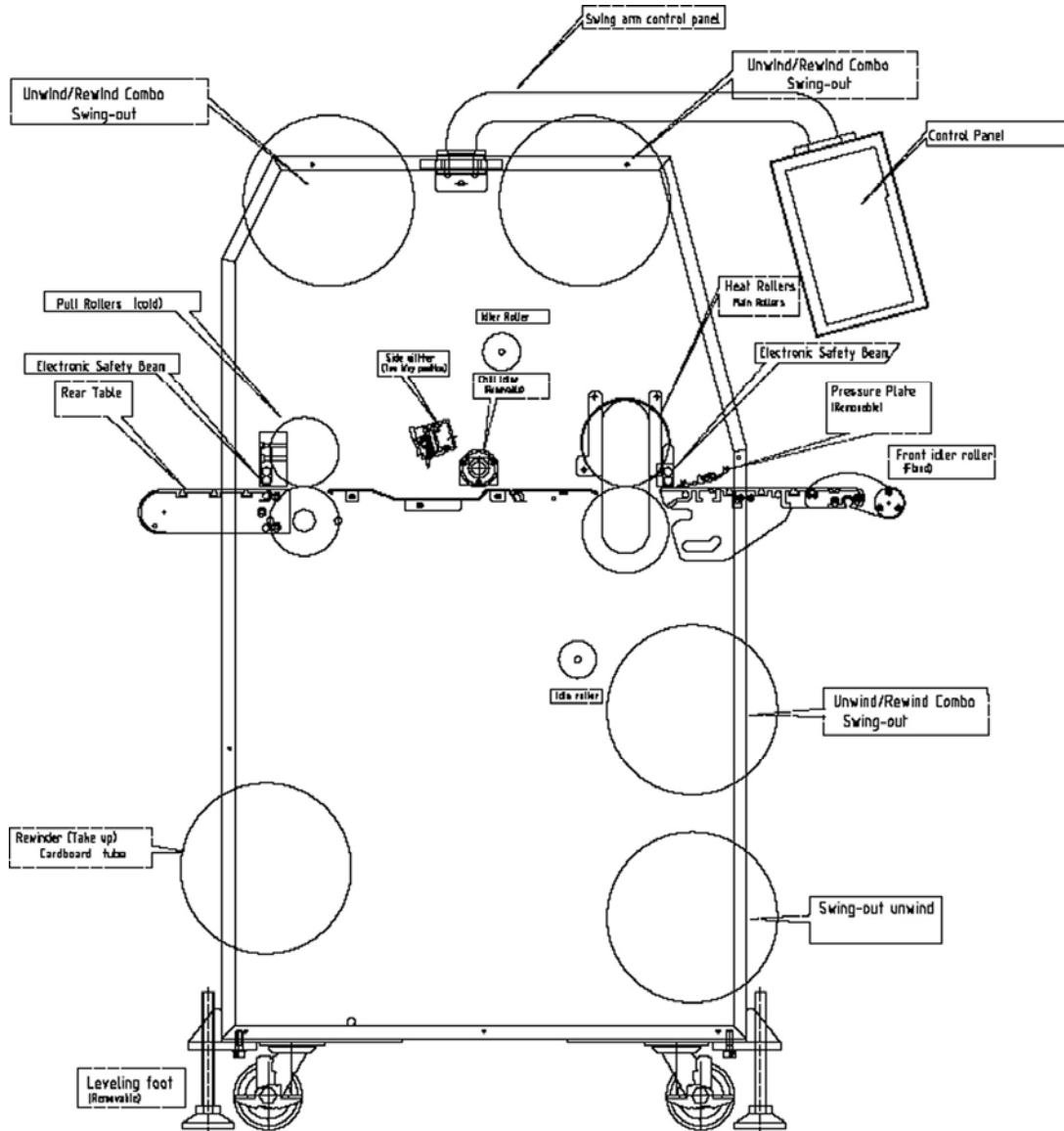

Refer to the following pages for detailed information on the above Features

**FEATURES GUIDE (DETAILED DESCRIPTION)**

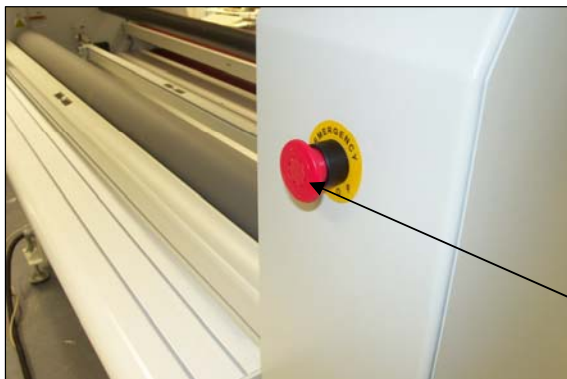

Figure 1

**EMERGENCY STOP BUTTONS**

(Fig. 1 – Item A)

Four emergency stop buttons are available on the Laminator on the top four corners of the Laminator.

To engage Emergency -stop button, Press any emergency -stop safety push button to stop the roller movement

To disengage, turn the push button clockwise after the emergency condition has been resolved.

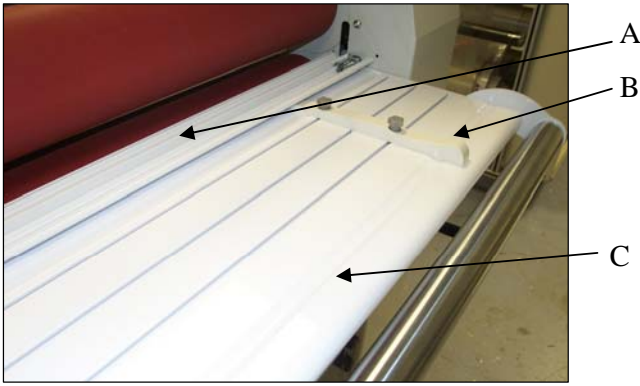

Figure 2



Figure 3

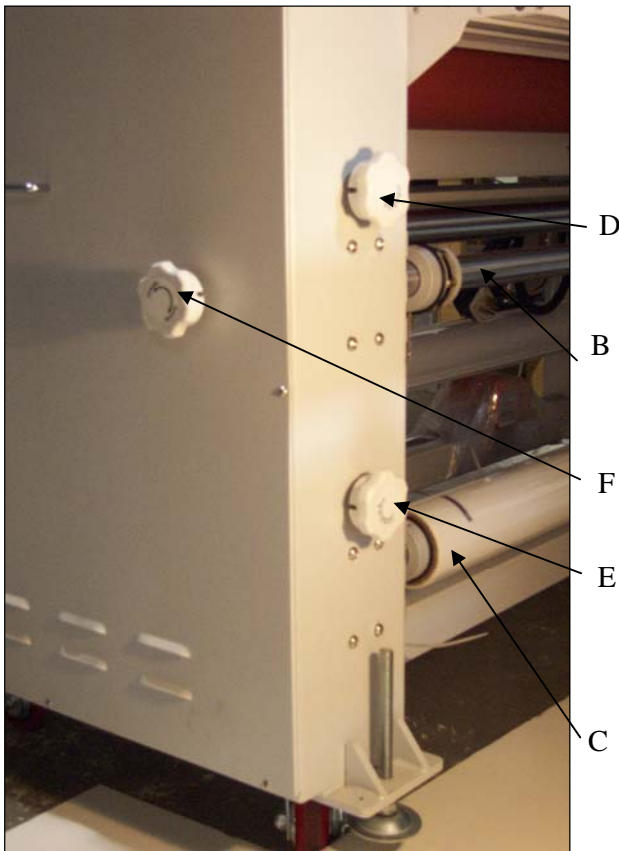

Figure 4

**Media Tables:** (Fig. 2C & 3C)

On both the Front Media & Rear Media tables, the safety interlock switch will not allow the Laminator to operate at full speed unless the tables are properly installed.

The Media tables are used to position items for Lamination. There are two media tables on the machine one on the front & one on the rear of the Laminator. The Front Media table incorporates an Idler on the leading edge of the table. This is used for roll to roll applications during lamination

**Note:**

The Laminator will operate only when the Media Table and Media Table Latch are Properly Installed.

**The Accessories Include:**

1. **Straight Slitter:** Used for slitting the media after lamination -- Rear Table. (Fig. 3 – Item B)
2. **Feed Guide:** Used for guiding Media through the laminator (Fig. 2B)
3. **Pressure Plate:** Used for guiding stock and ensuring a wrinkle free feed into the roller Nip. (Fig 2A)

**Rewind Take up:** (Fig. 3 – Item A)

This machine has one dedicated rewind film take up positioned on the lower back of the machine

**Swing out Film Unwind Shaft:** (Fig. 4C)

Swing out film unwind shaft is used to provide tension to materials going into the lamination roles. The unwind is located on the lower front of laminator. (Fig. 4 – Item C)

The swing out unwind shaft brake knob varies the tension. (Fig. 4E)

**Unwind / Rewind Combo:** (Fig. 4 & 5)

There are three unwind/rewind combo shafts, Two Top Combo Unwind/Rewind shafts, one on the top front and one on the top back of the machine (Fig. 5A) and the third combo unwind/rewind shaft is located below the front table (Fig. 4B).

Unwind / rewind combo shafts can be used as a standard swing out unwind for material supply or be used as a rewind for liners and final products.

The conversion from unwind to rewind just requires the release of the upper brake adjust knob (Fig. 4D) and tightening the rewind adjustment knob. (Fig. 4F)

**CAUTION:** When using the combo unwind / rewind shaft as a rewind, the upper brake adjust knob (Fig. 4D) must be released to limit the load on the motor, and wear & tear on the machine.

The film shaft clutch is then engaged to the turn with the motor to wind up film.

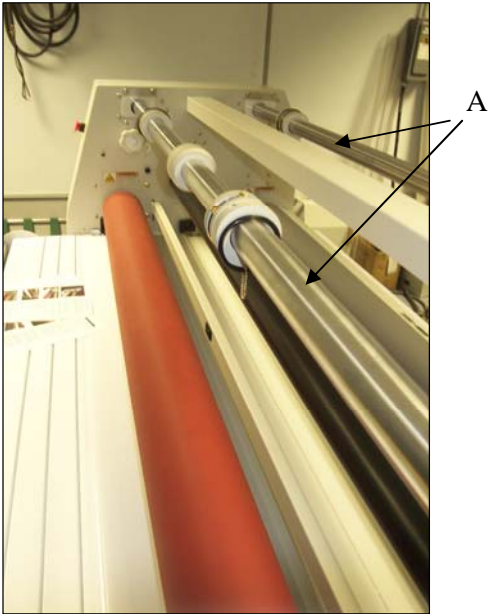

Figure 5

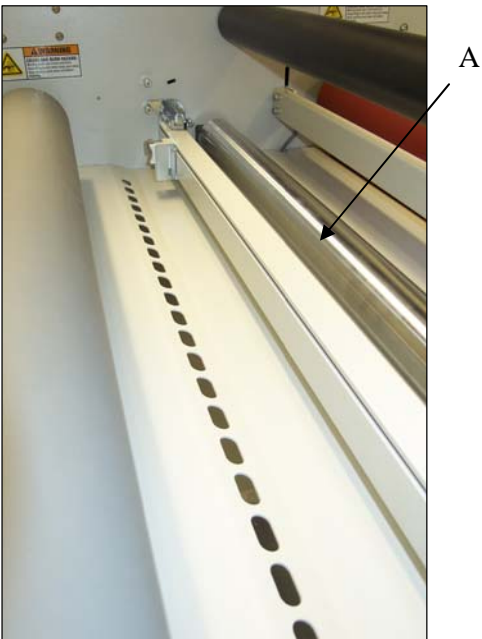

Figure 6

**Removable Chill Idler: (Fig. 6 – Item A)**

The removable chill Idler is used to help smooth out the laminating film during the cooling process.



Figure 7

**Upper Tension Idler:** (Fig. 7 – Item A)

Upper tension Idler guides the laminating film on to the main roll insuring a consistent amount of wrap on the upper rolls.



Figure 8

**Lower Tension Idler:** (Fig. 8 - Item B)

Lower tension idler guides the lower lamination film on to the lower roller.

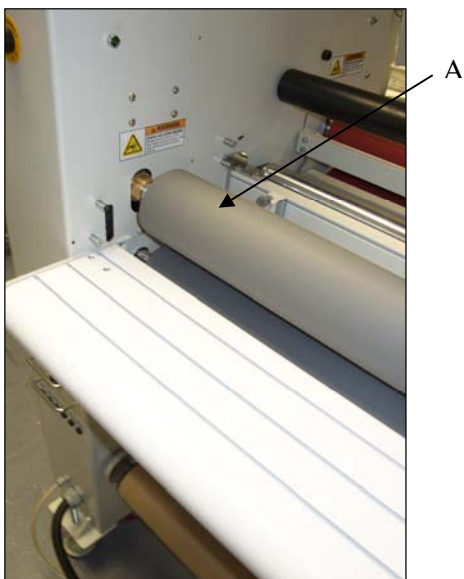

Figure 9

**Pull Rollers:** (Fig. 9 - Item A)

The Pull rollers located at the back of the laminator are motor driven. They simultaneously pull the film and improve the quality of the laminated item.

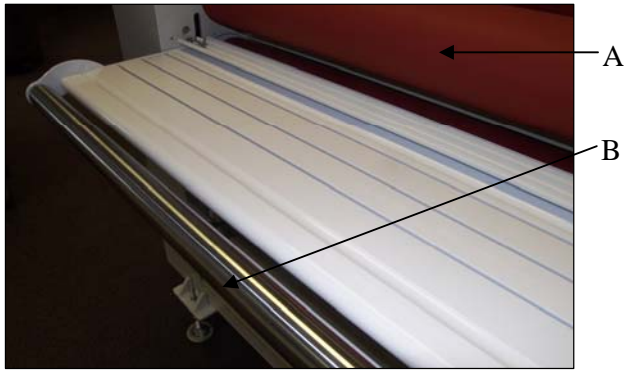

Figure 10

**Heated Main Rollers:** (Fig. 10 – Item A)

Silicone rubber coated steel tubes heat the laminating film and compresses the heated film to the items being laminated. Heat is provided by an internal heating element.

**Table Idler:** (Fig. 10 – Item B)

The Table Idler is used to assist in bringing the material up to the nip.

The table Idler is helpful in roll to roll operation and helps move large ridged panels through the nip.



Figure 11

**Main On  $\diamond$  /  $\otimes$  Off (I/O) Switch:**  
(Fig. 11 – Item A)

Located on the lower back of the control panel side of the GBC3064WF is the main power switch.

“I” means ON, “O” means OFF.



Figure 12

**Swing around control panel arm:**  
(Fig. 12 – Item A)

The Control panel is on a swing around arm which will allow the operator to move the necessary control to each side of the machine.

**Control Panel:** (Fig. 12 – Item B)

The Control panel has most of the machine controls to operate the machine.

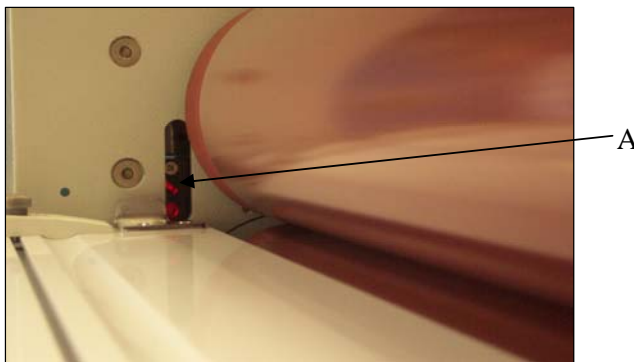

Figure 13

**Electronic Safety Beam:** (Fig. 13 – Item A)

Safety light beam is used to protect the Nip area with out being, in the way of normal lamination operation. Please see the following chart for sequence of operations on Page 14.



Figure 14

**Nip Pressure Adjustment:**  
(Fig. 14 & 15 –Item A)

The Nip pressure adjustment allows the operator to adjust the downward pressure of the pull rolls and main rolls.

**Pull Roll Lift handle:**

Turn the handle clockwise to lower the upper pull roll. (Fig. 14A)

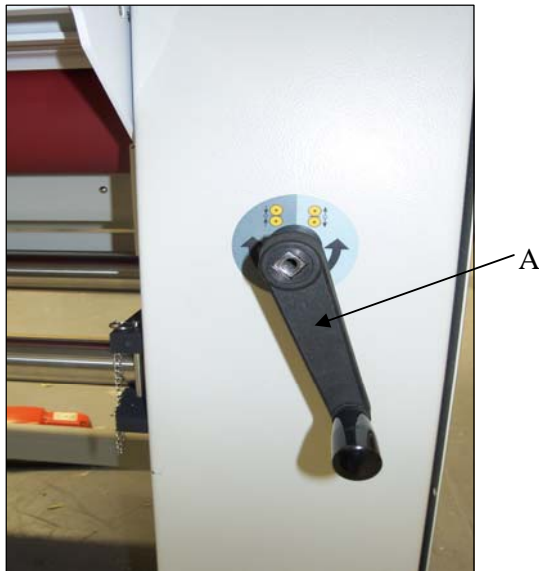

Figure 15

**Heated Main roll Lift handle:**

Turn handle clockwise to lower main roll & adjust the Nip Pressure (Fig. 15A)



Figure 16

**Pull Roll Clutch Adjustment Knob:**

The Pull Roll Clutch provides tension on the laminated film between the main rolls and pull rolls as the material is cooling. (Fig. 16A)

**SEQUENCE OF OPERATIONS**

**GBC U.S & CE 3064WF**

**Effect of Fiber Optics on sequence of operation**

Modes	Situation 1	Situation 2	Situation 3
Machine Run Mode	Normal operation (No Interruption to any safety circuitry & Fiber optic beam) <b>High speed.</b>	Interrupted fiber optic beam or opened any safety circuitry.	Fiber optic beam cleared + all safety circuitries are closed
Forward Mode Press push button forward switch	Control panel: Forward Speed: Zero to Max. Press "RUN" push button to switch over from foot switch to the control panel.	<b>Machine stops Instantly.</b> Use foot pedal to override @ 3f/m.	Machine will remain stationary until run switch is pressed. Push <b>RUN</b> button switch to run machine again (Normal operation) mode.
	Foot switch: Forward Speed: Zero to Max. <b>Note:</b> Press variable foot pedal to change mode and take over from control panel at preset speed.	<b>Machine Runs @ 3f/m.</b> (Automatic override from high to low voltage)	Machine still remains at low voltage speed of 3f/m. Steps required to run at (various speed): The operator will have two choices,  <b>Choice A:</b> 1. Release foot pedal to stop machine. 2. Press foot pedal again to start machine at original preset control panel knob speed (pot).  <b>Choice B:</b> 1. Press and hold "RUN" push button switch on the control panel while foot is still on pedal. 2. Release foot pedal. 3. Adjust speed using "speed knob"
Reverse Mode Press Reverse Push button switch.	Reverse speed: Zero to Max. Press "Run" push button to switch over from Foot switch to the Control panel.	<b>Machine stops Instantly.</b> Use Foot pedal to override @ 3f/m.	Machine must not run. It will remain stationary. Push <b>RUN</b> button switch to run machine again at Normal operation mode.
	Reverse speed: Zero to Max. <b>Note:</b> Press foot pedal to change mode and take over from control panel.	Machine Runs @ 3f/m. (Automatic override from high to low voltage)	Machine still remains at low voltage speed of 3f/m. Steps required to run at (various speed): The operator will have two choices,  <b>Choice A:</b> 1. Release foot pedal to stop machine. 2. Press foot pedal again to start machine at original preset control panel knob speed (pot).  <b>Choice B:</b> 1. Press and hold "RUN" push button switch on the control panel while foot is still on pedal. 2. Release foot pedal. 3. Adjust speed using "speed knob"

## OPERATING INSTRUCTIONS

### Film Loading & Threading

The top and bottom rolls of laminating film must be of the same width and be present simultaneously. A Small amount of adhesive will “squeeze out” during Lamination. Hardened adhesive deposits can damage the heat rollers.

### CAUTION:

Adhesive will deposit on the rollers if:

- Only one roll is used.
- Different widths of rolls are loaded together.
- Either roll is loaded adhesive side against a heat roller.
- One or both rolls of film are allowed to run completely off its core.

The adhesive side of the film is on the inner side of the web (Fig. 17A & B). The shiny side of clear film must contact the heat rollers. The dull side of the film contains the adhesive. Use extreme caution when loading delustered (matte) film as both sides appear dull.

Always change the top and bottom supply rolls at the same time. Near the end of each roll of GBC laminating film is a label stating “Warning-End of Roll”. The appearance of this label on either the top or bottom roll requires that new rolls of film be installed as soon as the item presently being laminated completely exits the rear of the laminator.

Do not introduce any additional items into the laminator when the warning label is visible.

### To load a roll of film: (Fig. 18)

1. Pull the swing out shaft clevis pin up.
2. Swing shaft outward.
3. Slide the roll of film onto the film shaft ensuring Adhesive side is out.
4. Push the film shaft back into the film shaft Support saddle.
5. Push the clevis pin down.
6. Center the roll of film.

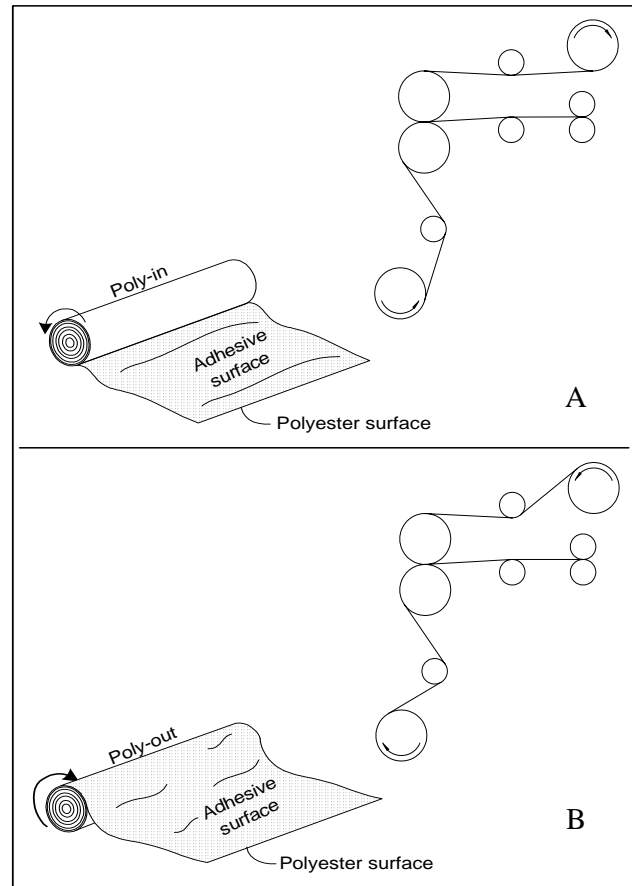

Figure 17

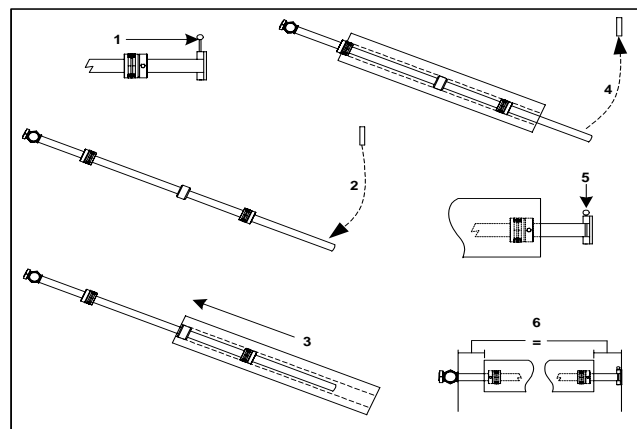





Figure 18

### Webbing Thermal Film Using Threading Card

**CAUTION:** The laminator rollers will be hot and can burn you.

1. Turn the Main Power ON  /OFF  to On. 
2. Set top and bottom temperatures to the appropriate setting for the film type used.
3. Ensure no brake tension is applied to the film shafts.
4. Pull the top roll film down under the upper idler bar and allow to drape over the top heat roller (Fig. 19)
5. Pull the lower film behind the lower idler bar, Lower the table, Pull Film up towards the film draped over the top heat roller and adhere the lower film to the upper Film (Fig. 20).
6. Pivot the table back to its feeding position while ensuring the threading card is on top of the feed table (Fig. 21).
7. Use a threading card to push the two materials into the heat roller nip.
8. Lower the main roller to initial contact with the threading card.
9. Ensure FRONT is selected for Motor direction and Press the Foot Switch
10. From the rear of the machine, guide the web over the chill idler, if installed, and through the pull rollers.
11. Once the web has entered the pull roller nip, lower the pull roller. Adjust unwind film tension; use as little tension as possible to get smooth output.
12. Once the threading card has completely exited the pull rollers, press the "STOP" () button.
13. Now refer to the section titled "START LAMINATING".

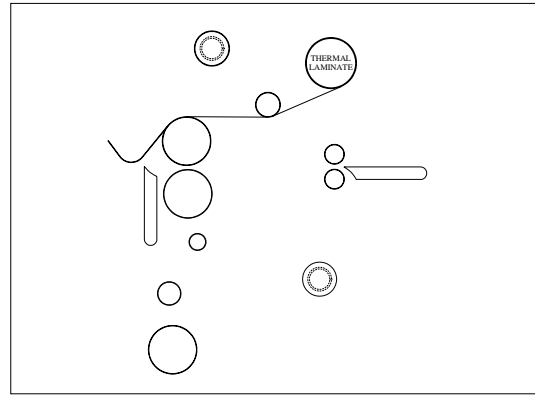

Figure 19

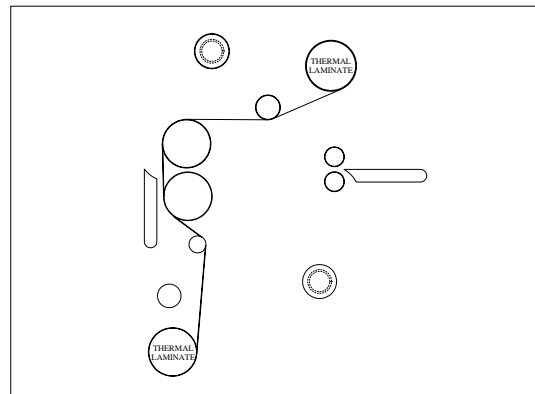

Figure 20

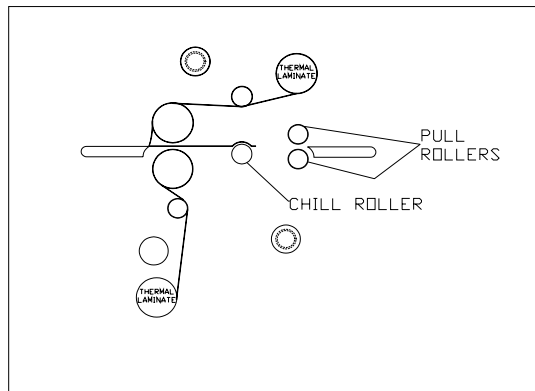

Figure 21

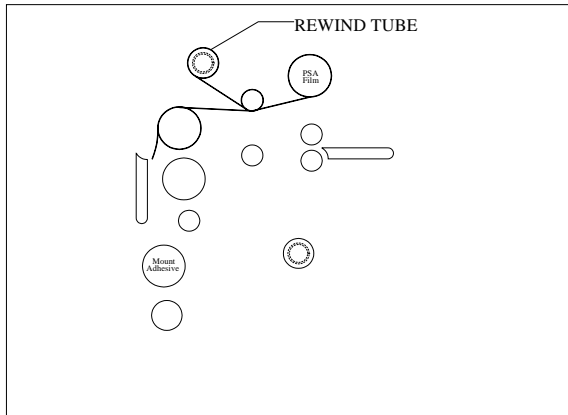

Figure 22

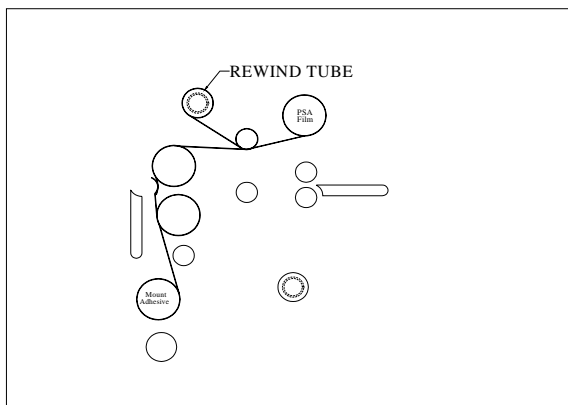

Figure 23

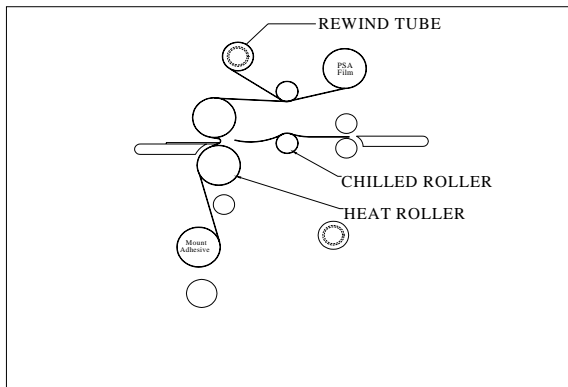





Figure 24

### Webbing PSA Film/Mount Adhesive Using Threading Card

The laminator should be cool to the touch before Proceeding.

1. Turn the Power ON  /OFF  to On 
2. Load the rolls of film as illustrated in (Fig. 22). Ensure no brake tension is applied to the film shafts.
3. Pull the top roll of film down under the idler bar and up to the upper front rewind tube.
4. Place one piece of masking tape in the center of the film and secure to the rewind tube.
5. Make two full wraps around the rewind tube, and then score the laminate without cutting the release liner. Pull the laminate down allowing it to drape over the upper roller (Fig. 22).
6. Pull the mount adhesive up towards the film draped over the upper heat roller (Fig. 23).
7. Stick the mount adhesive to the exposed adhesive of the upper roller.
8. Pivot the table back to its feeding position while ensuring the threading card is on top of the feed table (Fig. 24).
9. Use a threading card to push the two materials through the heat roller nip
10. Lower the main heated roller to bring the main roller into initial contact with the threading card. Ensure front is selected and press the foot switch.
11. From the rear of the machine, guide the web over the chill idler, if installed, and through the pull rollers. Once the web has entered the pull roller nip, close the pull roller nip.
12. Press the "STOP" () button when the threading card has completely exited the pull rollers and adjust the film web tension using as little tension as possible.
13. Now refer to the section titled "START LAMINATING".

**Start Laminating**

1. At this point you should have your laminator Webbed with the appropriate material for your application.
2. The feed table should be in the normal operating position.
3. Close the main and Pull roll nips. Rollers should be closed.
4. Speed is set to 3 or less and "FRONT" (▶) motor direction is selected.
5. Press the "START" (◊) button.
6. Set main roller pressure between 40% – 60% for laminating by turning the main roll lift handle.

**CAUTION: If using PSA film, an air pocket may result between the main rollers and pull rollers. Raise the pull rollers to allow the air Pocket to pass.**

7. Make any necessary film brake tension adjustments, pull/main roller pressure, and clutch and/ or rewind brake tension adjustments.
8. Position the item to be laminated on the feed table.
9. Align the leading edge of the item parallel to the heat roller nip (Fig. 25).
10. With both hands and an outward force push the image slower than the speed of the rollers into the nip of the heat rollers (Fig. 26).

**CAUTION: Avoid forcing the image into the main roller nip as this action will cause the corners of the leading edge to buckle and create a wave.**

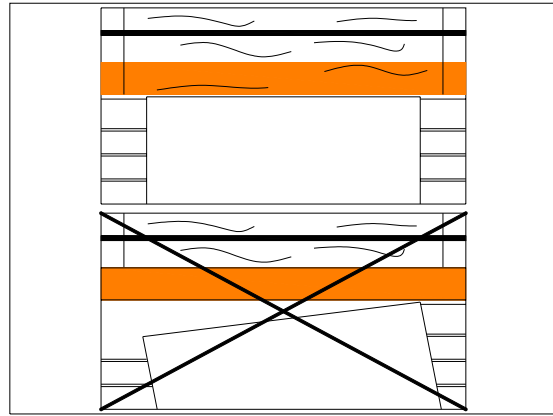

Figure 25

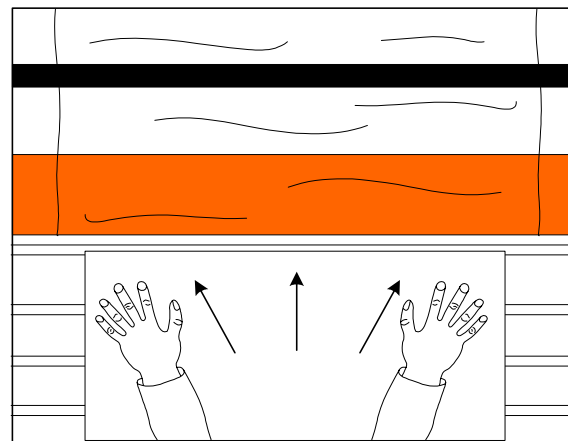

Figure 26

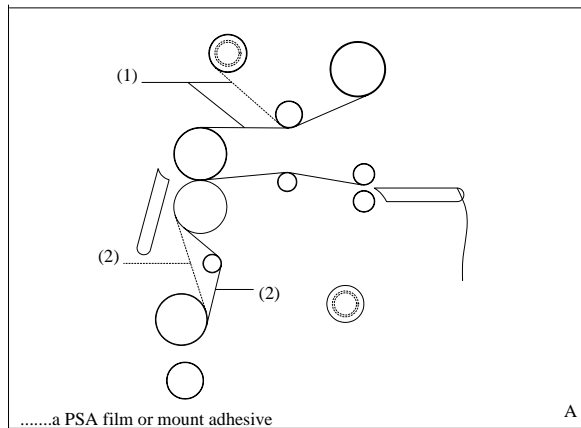

Figure 27

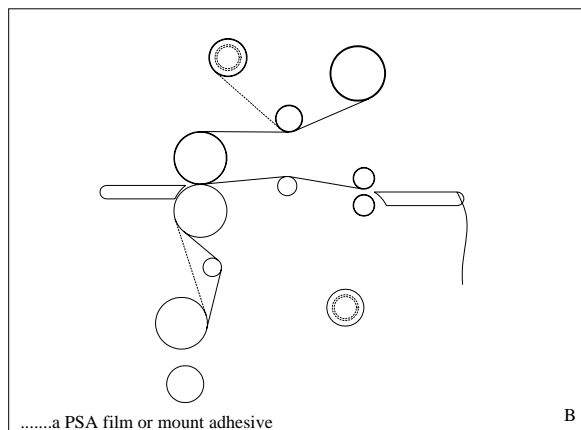

Figure 27

### Method for Tacking New Film to Existing Film

The following describes a method for loading film whereby the existing film present on the heat rollers may be used in place of the threading card to draw the new film through the laminator. The adhesive of the existing film must be tacky or liquefied. Leading edges of the new film will be overlapped onto the tacky adhesive of the old film. The existing film and the new film will be pulled through the laminator together.



**CAUTION: Do not cut yourself**

**CAUTION: Be careful not to cut any of the rollers!**

1. Cut (1) remaining top film web between the idler bar and heat roller. Cut (2) the film web between the lower film supply and the idler bar (Fig. 27).
2. Tilt the feed table down.
3. Do not allow the adhesive side of the film to contact the heat or pull rollers. Liquefied or tacky adhesive deposited on heat rollers will require the rollers to be cleaned per the section titled "MAINTENANCE".
4. Replace both the top and bottom rolls of film with new rolls. Ensure the adhesive side is facing out.
5. Pull the film around the idler bars, with the exception of PSA mounting adhesives without a release liner.
6. Tack the new film to the existing film on the heat rollers. For PSA film, attach the release liner to the rewind tube
7. Use the footswitch to advance the film into the heat roller nip.
8. Observe the film being pulled through the laminator to assure that the remaining existing film and the new films are advancing concurrently. Any separation between the films will require stopping the motor immediately and the situation corrected.
9. Press "STOP" (⏹) once the newly threaded film has completely exited the pull rollers.

**To unweb the laminator**

Unweb the laminator if you are changing film widths, cleaning the rollers or have finished using the machine for the day.

**⚠ CAUTION: Do not cut yourself**

1. Using the rear slitter, cut (1) the output from the web (Fig. 28).
2. Cut (2) remaining top film web between the idler bar and heat roller. PSA film cut the release liner too.
3. Cut (3) the film web between the lower film supply and the idler bar (Fig. 28).

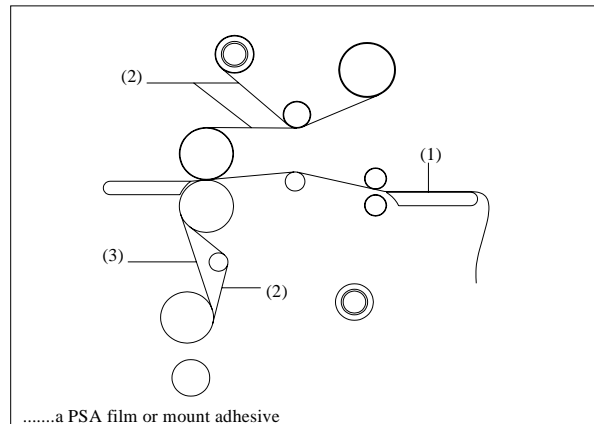

Figure 28

**CAUTION: Be careful not to cut any of the rollers!**

4. Tilt the feed table.
5. Gap the main rollers and pull rollers.
6. Carefully grab hold of the web (top and bottom film), from the back operating position and pull towards you (Fig. 29).
7. Do not allow the adhesive side of the film to contact the heat or pull rollers.

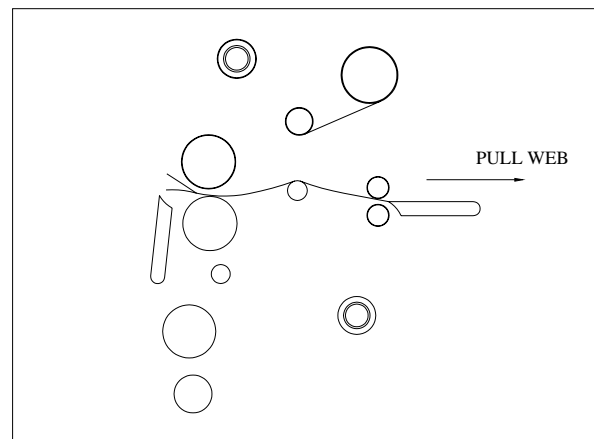

Figure 29

**Clearing a Film Jam (Wrap-up)**

Film jams (wrap-ups) may occur if the film is loaded backwards or if the area at which film exits the equipment is blocked. The film, when jammed, wraps around the heat rollers or pulls rollers during webbing if webbing, if a Threading Card is not used.

**To clear a jam:**

1. Immediately stop the laminator by pressing "STOP" (⏹).
2. Set motor direction to "REAR" (◀).
3. Use the footswitch to reverse the web until the wrap up is clear.
4. Raise the main roller and pull rollers.
5. Manually guide the web from the main rollers and pull rollers.
6. Once the film jam has been cleared, lower the main roller and pull rollers.
7. Refer to the section titled "START LAMINATING".

## APPLICATIONS

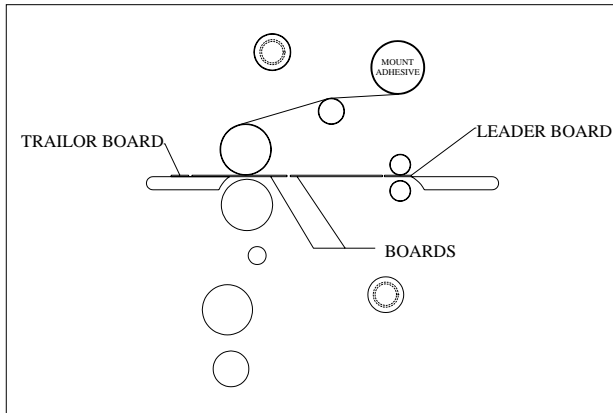

Figure 30

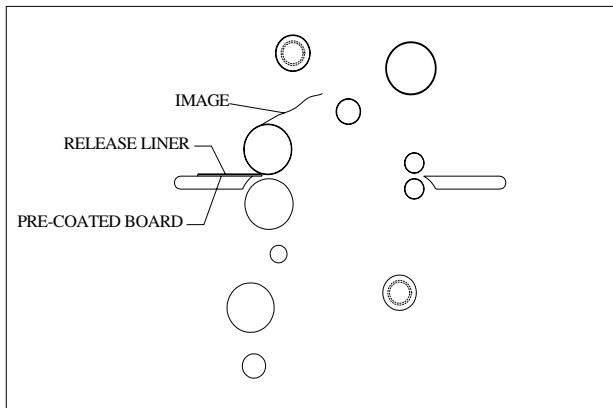

Figure 31

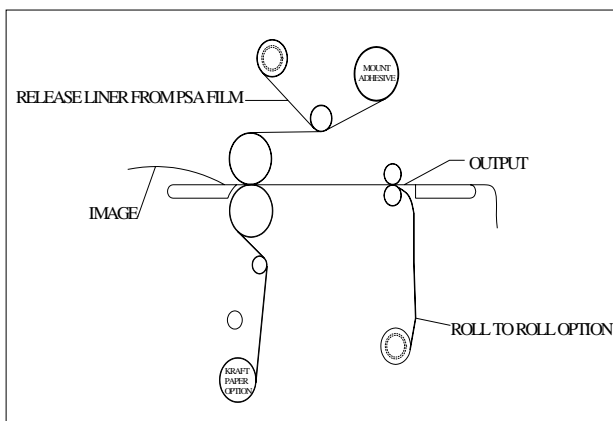

Figure 32

**Tips for Pre Coating Boards**

1. Load the laminator as illustrated in (Fig. 30). Remove chill idler.
2. The width of the roll should not exceed the width of the board by more than 1/2 in. (1.3 cm).
3. Use a leader board to set the main roller and pull roller pressure prior to webbing.
4. Use a leader board to start the run and a trailer board to finish the run.
5. Using the pull rollers will allow you to leave gaps between boards.
6. If not using the pull rollers, have the boards nearby to butt end to end during feeding.

**Tips for Mounting Pre Coated Boards**

1. Use a leader board to set the main roller pressure prior to mounting the image.
2. Ensure the chill idler is removed and the rear slitter is to one side.
3. Do not stop once you have started the mounting process through the machine. (Fig. 31)

**Note:** This application can also be performed from the rear operating position. Reference Fig. 34 for Illustration.

**Tips for Single Sided lamination**

1. Load the laminator as illustrated in Fig. 32.
2. Use kraft paper for one-sided lamination When ever the items to be laminated are narrower than the film you are using.
3. If not using kraft paper, use a scrap piece to finish the run or you will have adhesive on your rollers.
4. For high volume runs, use Kraft paper and the lower rear rewind for roll to roll operation.
5. Running the web over the chill idler may improve the Flatness of the output.
6. A little heat 125°F (52°C) may help eliminate silvering effects associated with PSA films.

**Tips for Creating a Decal**

1. Load the laminator as illustrated in Fig. 33.
2. The over laminate may be PSA or thermal type.
3. If using thermal type, pay attention to the Poly-in/Poly-out rule.
4. Run a test material prior to running the actual image to ensure flat output.
5. Use minimal brake tension to achieve quality output.
6. Do not web the PSA mount adhesive around the lower web idler.

**Tips for mounting a Decal**

1. Use a leader board to set the pull roller pressure Prior to mounting the image.
2. The image should not exceed the width of the board by more than 1 in. (2.54 cm) per side.
3. Tack about 1 in. (2.54 cm) of the leading edge of the image to the leading edge of the board.
4. When tacking the leading edge, start in the center and work to the sides.
5. Use a board that exceeds the size of the decal if inexperienced in the mounting application.

**Note:** This application can also be performed from the front operating position. Reference Fig. 31 for illustration.

**Tips For Thermal Encapsulation**

1. Load the laminator as illustrated in Fig. 35 Poly-in film is used for illustration purpose.
2. Refer to section titled "FILM LOADING & THREADING" for Poly-out film.
3. Always use two rolls of film the same width.
4. Use minimal brake tension to achieve flat output.
5. Increase speed gradually to maintain the activating temperature required for the laminate you are using.
6. Length and width of image, ink coverage and paper type may affect the temperature and speed recommended in the SPEED/ TEMPERATURE GUIDE.

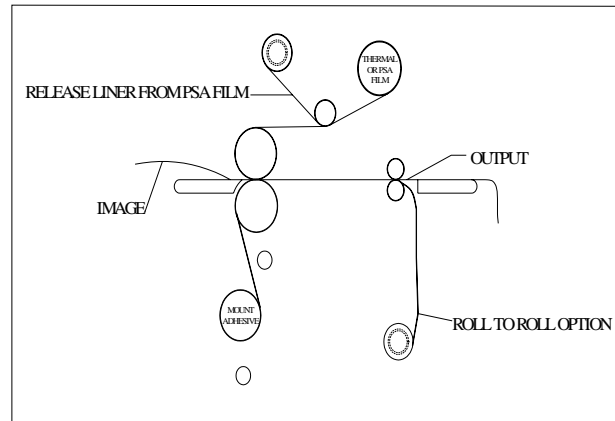
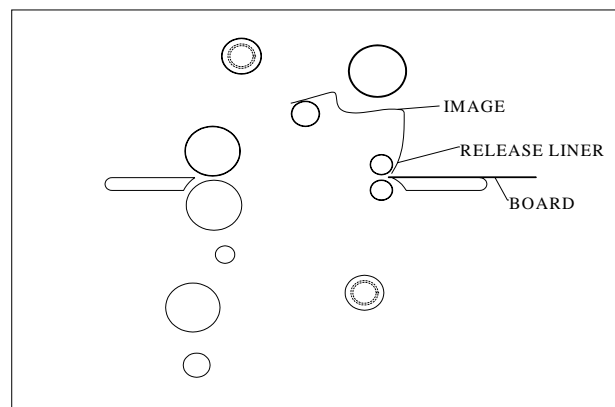
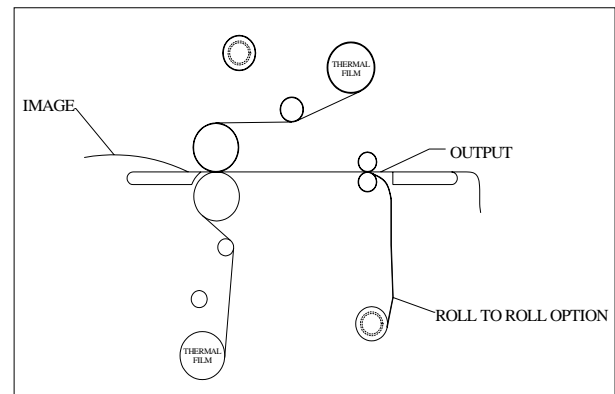
**Figure 33****Figure 34****Figure 35**

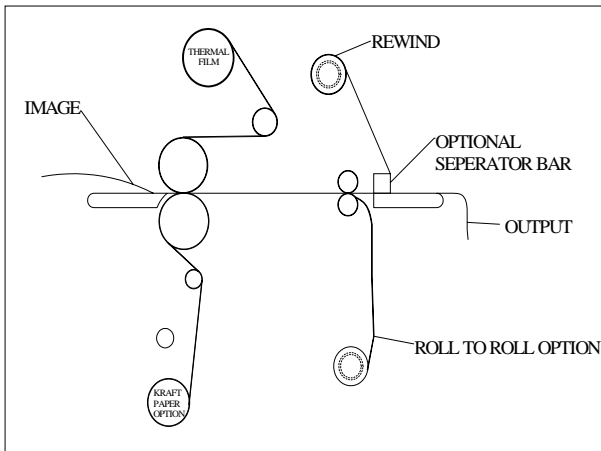

Figure 36

**Tips for ACCUSHIELD**

1. Load the laminator as illustrated in Fig. 36.
2. You must have the Separator bar option to accurately run this material.
3. Set Top Temp to 265°F (129°C) and a speed setting no greater than 4.
4. Liner rewind tension will be greater than normal operating standard
5. To prevent some adhesive adhering to the rollers, you may choose to use a roll of craft paper for a Carrier.

Use the blank space below and blank diagrams to Note your tips and web paths for your Special applications.

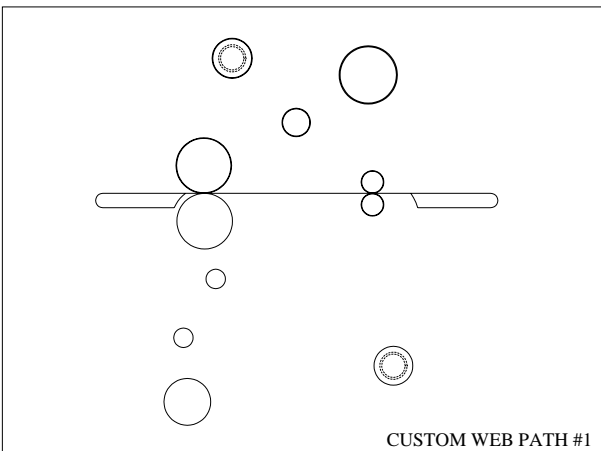

Figure 37

**TIPS FOR CUSTOM APPLICATION #1 (Fig. 37)**

- 1.
- 2.
- 3.
- 4.

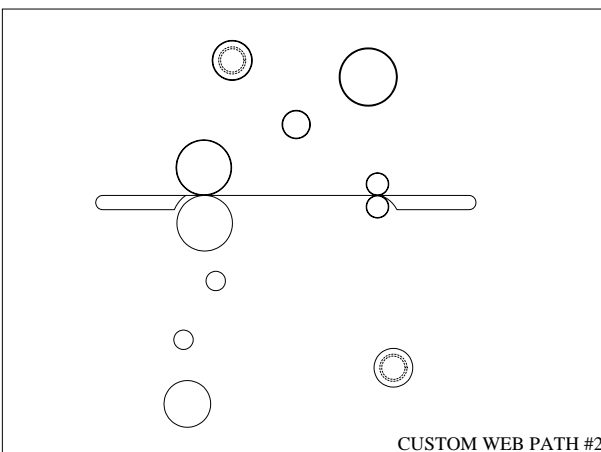

Figure 38

**TIPS FOR CUSTOM APPLICATION #2 (Fig. 38)**

- 1.
- 2.
- 3.
- 4.
- 5.

**SPEED / TEMPERATURE CONTROL**

This is only a general reference guide. Different settings may be suitable as the warm up time, lamination time and materials change.

Factors that may affect the speed and temperature parameters;

1. Image length
2. Image width and ink coverage.
3. Ink coverage
4. Paper type
5. Laminate thickness
6. Operating environment
7. Condition of the rollers
8. Line voltage (effects heaters)
9. Using cooling features.

You may have to adjust temperature or speed depending on stock finish, thickness \*Turn heat off when not in use.

**THE ART OF LAMINATION****BASIC RULES**

- Do not attempt to laminate abrasive or metal Objects such as staples, paper clips and glitter, as they may damage the heat or pull rollers.
- Do not force items into the nip area of the heat rollers. An item that is not easily drawn into the laminator by the heat rollers is probably too thick to laminate.
- Wrinkles may result if an attempt is made to reposition an item once it has been grasped by the heat rollers.
- Do not stop the laminator before an item has completely exited the pull rollers. Even a momentary stop will cause a mark (heat line) on the laminated item.

Good, consistent lamination is a result of combining proper heat, tension and dwell time. Dwell time is controlled by the speed of the motor and is defined as the amount of time the material to be laminated is compressed between the heat rollers.

As a general rule, thicker items and film need to run at slower speeds because they extract more heat from the rollers at a quicker rate. Setting the speed control at slower settings gives the laminator longer dwell time thus allowing proper lamination of thick items. Thinner items, such as standard copier paper (20 lb. bond) and tissue paper, extract less heat from the rollers and can be run at faster speeds.

**FILM TENSION**

Proper film tension, known as brake tension, is the minimum amount required to eliminate wrinkles in the finished item. The film should be taut. A properly adjusted roll of film should not require excessive force to turn by hand.

Film tension should be enough to introduce a minor amount of drag as the film unrolls. Insufficient tension causes wrinkles, while too much tension causes stretching (necking). Uneven tension between the top and bottom rolls creates curl. Too much upper tension creates upward curl while too much bottom tension causes downward curl.

Adjustment of the pull roller clutch may be necessary if after adjusting unwind and rewind brake tensions do not improve your output quality.

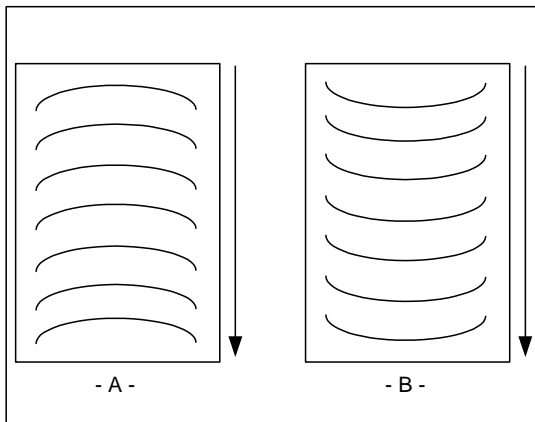

Figure 39

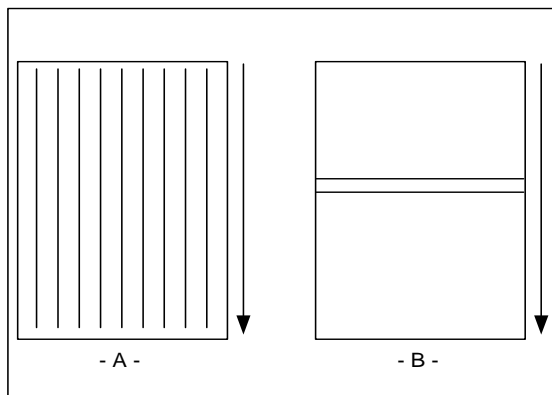

Figure 40

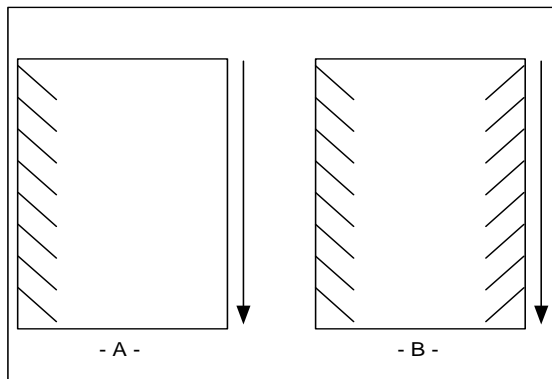

Figure 41

## Heat

The "READY" indicator may extinguish if the speed is set too fast for the material being laminated. Either lower the speed setting or press "STOP" (⊗) and wait until the "READY" indicator illuminates. Operation of the laminator for more than thirty minutes at a time may necessitate a lower speed setting. It is recommended that, during periods of long runs, the items being laminated are alternated between thick and thin. Do not combine thick and thin items at the same time, as this will result in a poor edge seal around the thinner material. If you are unsure that the laminator is set at the proper speed for the item to be laminated, run a test piece (scrap) of the same or similar material through the Laminator. This procedure is recommended because rotating the heat roller prior to lamination will more evenly distribute the heat.

Make speed adjustments if necessary.

## Output

1. "D" waves in the image (Fig. 39 A).
  - Check paper tension.
  - Paper may be damp or not dry.
2. "D" waves in the laminate (Fig. 39 B).
  - Check main roller pressure.
  - Check pull roller pressure.
3. Straight waves in output (Fig. 40 A).
  - Check operational settings for materials being used.
  - Check clutch tension.
4. Indent waves in output after pull rollers
  - Insufficient cooling time.
  - Output was handled prior to cooling.
  - Use cooling feature if not on.
  - Machine was stopped on print.
5. Angled waves in the output
  - Main air Supply setting
  - Check main Roller Pressure.
  - Check main roller pressure.
  - Check pull roller pressure.
  - Check for Paper Tension.

**MAINTENANCE****Caring For The GBC 3064WF Laminator**

GBC offers Cleaning kits as well as Extended Maintenance Agreements.

Contact your local GBC Service Representative or your dealer/distributor for additional information. The only maintenance required by the operator is to periodically clean the heat rollers and schedule semi annual maintenance checks. The following procedure will help keep the heat rollers free of adhesive that has been deposited along the edge of the laminating film. Proper alignment of the rolls of film reduces the amount of "squeeze out".



**WARNING:** Do not attempt to laminate adhesives marked "Flammable".  
Do not laminate glitter and/ or metallic items. Damage to the rollers may result.



**WARNING:** Do not apply any cleaning fluids or solvents to the rollers. Some solvents and fluids could ignite on heated rollers.  
Never clean rollers with sharp or pointed objects.  
Hardened adhesive deposits on the rollers can cause damage to the rollers. Rotate the rollers at the lowest speed setting on the control panel.



**CAUTION:** THE FOLLOWING PROCEDURE IS PERFORMED WHILE THE LAMINATOR IS HOT. USE EXTREME CAUTION.

1. Remove the film from the laminator following the Procedure outlined in steps 1 through 6 of the section entitled TO UNWEB THE LAMINATOR.
2. Preheat the laminator until the "READY" indicator illuminates.
3. Tilt the feed table.
4. Rub the top and bottom heat rollers with a 3M™ Scotch-Brite™ pad . DO NOT USE METAL SCOURING PADS!
5. Use the footswitch to rotate the lower heat/ pull roller to an unclean portion. The upper heat/ pull rollers are free spinning. Continue this process until the complete surfaces of both rollers are clean.
6. Refer to the beginning of the section titled "OPERATING INSTRUCTIONS" to web your laminator.

**NOTE:** Do not use metal scouring pads to clean the rollers.

**TROUBLE SHOOTING GUIDE**

SYMPTOM	POSSIBLE CAUSE	CORRECTIVE ACTION
The control panel display does not illuminate when POWER ON/OFF is in the ON, marked "I", position.	Laminator not connected to electrical supply	Insert attachment plug into receptacle
	Blown out fuse.	Check fuses.
Heat rollers do not turn when POWER ON/OFF is in the ON, marked "I", position.	Feed table not properly installed.	Tilt feed table and properly replace it.
Press the "RUN" (◊) button and the motor does not turn.	E-Stop button activated	Pull out on the E-STOP turn clockwise.
Heat rollers only turn if I use the "Footswitch".	Photo eye is blocked.	Disengage the footswitch mode. Clear nip area.
Laminated items exhibit curling.	Tension between the top and bottom film. Roll is unequal.	Adjust tension per section FILM TENSION.
	Tension on top or bottom roll of film is too film is too loose.	Adjust tension per section FILM TENSION.
	Bottom film roll may be improperly loaded.	Make sure bottom roll of film is around idler bar and that is the normal operation position.
Adhesive deposited on heat rollers.	Top and bottom film webs not aligned	Release heat and pull roller pressure, align the rolls of film.
	Laminate improperly loaded.	Adhesive (matte) side of laminate film may be against the heat rollers. Unweb and reload the film properly.
	Speed setting too fast for type of material being laminated	Lower speed setting.
	Insufficient heat	Wait for "READY" indicator to appear in the control panel display.
	Laminate improperly loaded	Adhesive side of film must be facing away from the heat rollers.
	Heat rollers require cleaning.	Bottom roll of film not threaded behind the idle bar.
	Laminated item unsuitable for adhesion.	Clean heat rollers per procedure in section CARING FOR THE GBC 3064 WF LAMINATOR. Item may be dirty or may have non porous surface that is extremely difficult to laminate.

**SERVICE AGREEMENT**

GBC's Equipment Maintenance Agreement will insure the quality performance and long life built into your laminator.

A service charge for travel time, labor and parts may be incurred for each out of warranty service call. GBC's Equipment Maintenance Agreement decreases these expenses and protects your valuable investment. GBC offers several types of agreements to suit your needs and budget. To contact

**GBC write to:**

GBC NATIONAL SERVICE  
ONE GBC PLAZA  
NORTHBROOK, IL 60062 U.S.A.

**IN CANADA:** GBC NATIONAL SERVICE  
49 RAILSIDE ROAD  
DON MILLS, ONTARIO  
M3A 1B3

General Binding Corporation  
One GBC Plaza  
Northbrook, IL 60062-4195

®