

# GBC eWire Pro

## Service Manual

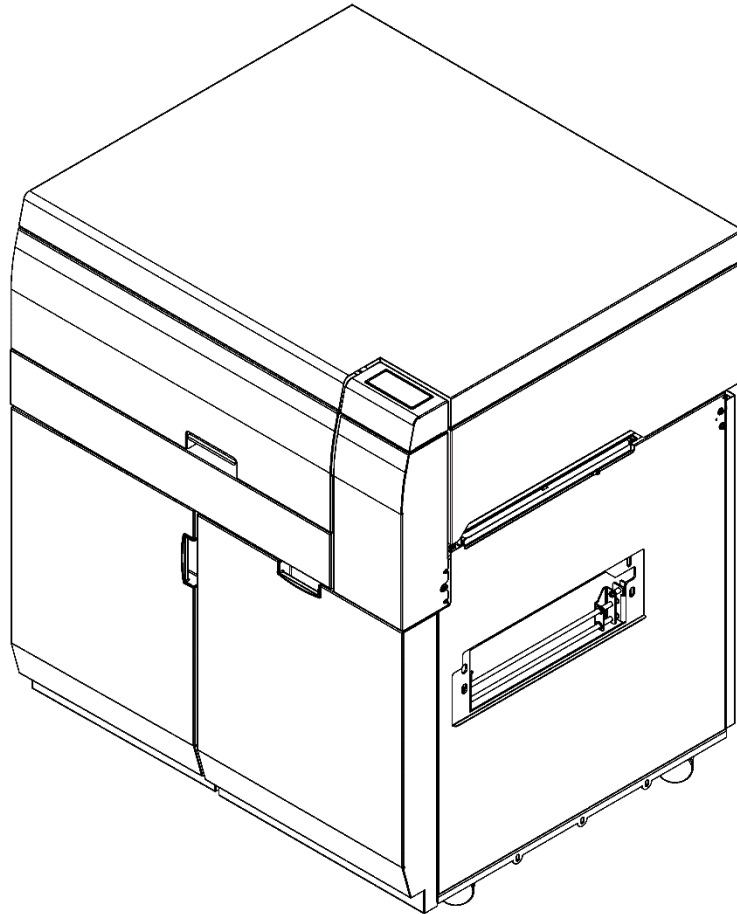

Part Number: 7716519  
Revision Number: F1  
Issue Date: March 2022



## Quick Start

Below is an excerpt from page 1-3. These steps should be performed at the start of every service call and will direct you through the use of the manual.

At the start of every service call, you should perform the following:

- If called for a problem, determine the exact nature of the service complaint. Determine the paper type and quality, especially as it relates to curl. Determine the size and color of twin loop wire being used.
- Identify if any media changes correlate with the emergence of the customer issue.
- Determine if the problem occurs with all element sizes or only specific sizes. If multiple sizes have not been used, try running the eWire using a different wire size.
- Do GP 6.2.7 to note the total machine bind and sheet cycles.
- If possible, run a bind cycle and evaluate the quality of the bound book. Refer to Section 3 of this manual for additional information regarding the book quality.
- Do GP 6.8 and GP 6.7 to replace the supply spool and re-evaluate the performance using the new supply spool.
- Determine the date of the last preventative maintenance performed on the system. Perform preventative maintenance as indicated on page 1-5.
- Vacuum the paper path, element feeder, and book stacking areas. Visually inspect the eWire and clear any scraps/debris.
- Save the system settings to a data file.
- Download a log file to USB. Note any error codes, especially if they occur repeatedly.

## SYSTEM CHECKS

### Purpose

Direct repair activity for problems found in Initial Action.

### PROCEDURE

1. Select the appropriate condition from the list below and perform the directed service actions.
  - Replace any obviously broken parts.
  - If there is a Book Quality problem but no Fault Codes or other obvious problems, go to Section 3.
  - If there is a Fault Code, go to Section 2 Table of Contents. Locate and perform the RAP associated with the code.
  - If there is an Operator Message that will not clear, go to Section 2 Table of Contents. Locate and perform the steps in the OPERATOR MESSAGE RAP associated with the Operator Message.
  - If the problem is not repeatable, operate the eWire in the same job conditions the customer used and recheck for a problem in the categories listed here.
  - If the problem is still not reproduced, examine the Machine Service Log and note any repeating faults. Refer to the RAP for those faults in Section 2 to check if the RAP relates to the customer problem. If so, perform the RAP.
  - If general problems occur that are not related to any fault code, repeat the steps in install section.
  - If the problem is not resolved after 2 hours, escalate to Canon 2<sup>nd</sup> level support.
  - If none of the above situations apply, go to EVERY CALL ACTIVITIES on page 1-4.
2. Verify that the problem is corrected and go to EVERY CALL ACTIVITIES on page 1-4.

---

# Table of Contents

## NOTICE

All service documentation is supplied to external customers for informational purposes only. Service documentation is intended for use by certified, product trained service personnel only. GBC does not warrant or represent that such documentation is complete. GBC does not warrant or represent that it will notify or provide to such customer any future changes to this documentation. Service by the customer of the equipment, or modules, components, or parts of such equipment may void any otherwise applicable GBC warranties. If customer services such equipment, modules, components, or parts thereof, Customer releases GBC from any and all liability for actions by the Customer, and Customer agrees to indemnify, defend, and hold GBC harmless from any third party claims which arise directly or indirectly from such service.

Changes are periodically made to this document. Changes, technical inaccuracies, and typographic errors will be corrected in subsequent editions.

## Copyright Notice

GBC  
ACCO Brands Inc.  
Four Corporate Drive  
Lake Zurich, IL 60047.  
USA

© Copyright 2014 by ACCO Brands Inc. All Rights reserved.

No part of this document may be photocopied or reproduced by any means, or translated to another language without prior written consent of GBC

All brand names, trademarks and registered trademarks are the property of their respective owners. Information contained within this document is subject to change without notice.

GBC products mentioned in this publication are registered trademarks of the ACCO Brands Corporation.

## Title

## Page

### Service Call Procedures

Introduction .....	iii
1. Service Call Procedures .....	1-1
2. Repair and Troubleshooting Procedures .....	2-1
3. Book Quality .....	3-1
4. Replacement and Adjustment Procedures.....	4-1
5. Parts List .....	5-1
6. General Procedures .....	6-1
7. Wiring Data .....	7-1
8. Installation Instructions.....	8-1

## **Section Contents**

<b>Title</b>	<b>Page</b>
Table of Contents.....	iv
Introduction .....	v
Organization .....	vi
How to Use This Documentation .....	vi
Other Information .....	vii
The Use of Caution, Warning, and Note statements .....	vii
Safety Devices .....	viii
CAUTION .....	viii
Operational Safety.....	viii
Important safeguards .....	ix

## Organization

This documentation is divided into eight sections. In addition to the Introduction, this documentation contains the following sections.

Section 1	Service Call Procedures
Section 2	Repairs and Troubleshooting Procedures
Section 3	Book Quality
Section 4	Replacement and Adjustment Procedures
Section 5	Parts List
Section 6	General Procedures
Section 7	Wiring Data
Section 8	Installation Instructions

## How to Use This Documentation

### Introduction

This section provides the Service Representative with information pertaining to the organization and use of this service documentation.

### Section 1: Service Call Procedures

This section is used by the Service Representative as a structured process for determining the type and sequence of actions that are performed during a service call. The Service Call Procedures section is designed to assist in the effective recognition of machine symptoms and problems, as well as to provide instructions for the maintenance and corrective actions that are required to return the machine to the full operating condition

Section 1 of this service documentation is the entry level for all service calls. The Service Representative should begin each service call with the Initial Action Procedure found in Section 1.

The Service Call Procedures section is composed of five integral elements: Initial Action, System Checks, Every Call Activities, Scheduled Maintenance, and Final Action.

The maintenance and diagnostic activities in this section may direct the Service Representative to perform additional service activities found elsewhere in the documentation, such as RTPs, Replacement Procedures, and Adjustment Procedures.

### Section 2: Repairs and Troubleshooting Procedures (RTP)

Section 2 of this documentation contains the Repair and Troubleshooting Procedures (RTPs) necessary to repair all faults associated with eWire. Service Representative will be referred to this section from some other section of this documentation during the service call. When a machine defect or fault has been resolved by using a RTP, the Service Representative should immediately return to the point in the service call from which Section 2 was entered. There are two types of RTPs found in Section 2. The first type is a RTP that is associated with the display of an error message in the RTP title. The second type is the Troubleshooting RTP. Troubleshooting RTPs are diagnostic procedures that are designed to address symptoms or problems that are not identified by, or associated with, a displayed status or fault code.

### Section 3: Book Quality

This section is used to diagnose book binding problems.

### Section 4: Replacement and Adjustment Procedures

This section contains all repair and adjustment procedures for the machine. Repairs (REPs) and adjustments (ADJs) are identified by the use of a standard chain prefix number.

### Section 5: Parts List

This section contains a list of spare parts for the machine. All parts list page reference numbers begin with the letters "PL", followed by a prefix number, a decimal point, and a sequential number used within the subsystem.

## **Section 6: General Procedures**

This section contains procedures and information of a general nature that apply to the machine. This section is divided into two basic parts: General Procedures and General Information.

## **Section 7: Wiring Data**

This section contains support information to assist in the electrical diagnosis of machine problems and is a central location for electrical wiring diagrams. This section is used in conjunction with other diagnostic or maintenance procedures that are contained in other sections of the service documentation.

## **Section 8: Installation**

This section contains service information that supports the GBC eWire Pro Installation.

## **Other Information**

### **The Use of Caution, Warning, and Note statements**

Information relative to the completion of a task in a safe or thorough manner will be supplied in the form of a Caution, a Warning, or a Note statement. These statements are found throughout the service documentation.

Cautions, Warnings, and Note statements appear before the steps to which they apply. These statements should be read before continuing to the next step in a procedure.

**Caution** - A Caution statement indicates an operating or maintenance procedure, practice, or condition that, if not strictly observed, could result in damage to, or destruction of, equipment.

**Warning** - A Warning statement indicates an operating or maintenance procedure, practice, or condition that, if not strictly observed, could result in personal injury or loss of life.

**Note** - A Note statement indicates an operating or maintenance problem, practice, or condition that is necessary to accomplish a task efficiently.

## Safety Devices

The GBC eWire™ Pro has door interlocks to prevent personal injury when operating the machine.

When you open a door, a Safety Interlock device automatically disables the drive motors until you close the doors.

When a door is open, the Operator Interface Panel displays the “CLOSE DOOR” message on the top line of the interface.

When you close all the doors, the Operator Interface Panel displays the “READY” message on the top line of the interface.

## CAUTION

Certain components in the GBC eWire Pro are susceptible to damage from electrostatic discharge. Observe all ESD procedures to avoid component damage.

## Operational Safety

Do not operate the GBC eWire™ with the interlocks defeated.

Use care when a procedure in this Manual instructs you to “insert an Interlock Cheater” in order to test the operation of a component.

### WARNING

**Moving Parts, keep hands clear of nips and the belts when the Interlock Cheater is inserted.**

THE FOLLOWING PICTORIAL IS FOUND ON THE eWire™ Pro:



This safety symbol means that you might get seriously hurt or killed if you open the product and expose yourself to hazardous voltage. NEVER remove the screwed on covers. ALWAYS refer service requirements to qualified service personnel.



This safety symbol means that you may get cut if you touch the knife positioned behind the cover it is affixed to. Do not remove this cover or place fingers behind it.



## Important safeguards

- ◆ Use the eWire™ Pro only for its intended purpose of creating bound books according to the indicated specifications.
- ◆ Retain this Operation Instructions manual for future use.
- ⚠ CAUTION: THE PRINTER ON/OFF SWITCH DOES NOT CUT OFF POWER FROM THE EWIRE™ PRO.
- ⚠ CAUTION: THE EWIRE™ PRO ON/OFF SWITCH DOES NOT CUT OFF POWER FROM THE PRINTER.
- ◆ The eWire™ Pro must be connected to a supply voltage corresponding to the electrical rating of the machine operation instructions (also listed on the serial number label).
- ◆ The grounding plug is a safety feature and will only fit into the proper grounding-type power outlet. If you are unable to insert the plug into an outlet, contact a qualified electrician to have a suitable outlet installed.
- ◆ Do not alter the plug on the end of the cordset (if provided) of the eWire™ Pro. It is provided for your safety.
- ◆ Unplug the eWire™ Pro before moving the machine.
- ◆ Do not operate the eWire™ Pro if the machine has a damaged power supply cord or plug. Do not operate the machine after any malfunction. Do not operate the machine in case of liquid spills, or if the machine has been damaged in any other way.
- ◆ Do not overload electrical outlets beyond their capacity. To do so may result in fire or electrical shock.

Do not open any panels other than those indicated by this Manual.

- ◆ Pay particular attention to the WARNINGS and CAUTIONS listed in the User Manual and Service Manual.

**Notes:**

---

# 1. Service Call Procedures

## Section Contents

<b>Title</b>	<b>Page</b>
CALL FLOW .....	1-2
INITIAL ACTION .....	1-3
SYSTEM CHECKS .....	1-3
EVERY CALL ACTIVITIES .....	1-4
SCHEDULED MAINTENANCE .....	1-4
eWIRE MAINTENANCE SCHEDULE .....	1-5
Customer Maintenance.....	1-5
Periodic Maintenance .....	1-5
Periodic Replacement.....	1-5
FINAL ACTION .....	1-6

## CALL FLOW

### INITIAL ACTION

This step is used to gather information about the reason for the call, to determine the machine condition, and to run a book sample if possible.



### SYSTEM CHECKS

This step is used to suggest a direction for using the information obtained during Initial Action. You can then repair and verify the effectiveness of the repair. This step may also provide information to assist in the identification of new problems and suggest actions to take to repair/resolve them.



### FINAL ACTIONS

This step is used to ensure that the machine performance and book quality are satisfactory. It will also provide direction to help complete administrative tasks.

## INITIAL ACTION

At the start of every service call, you should perform the following:

- If called for a problem, determine the exact nature of the service complaint. Determine the paper type and quality, especially as it relates to curl. Determine the size and color of twin loop wire being used.
- Identify if any media changes correlate with the emergence of the customer issue.
- Determine if the problem occurs with all element sizes or only specific sizes. If multiple sizes have not been used, try running the eWire using a different wire size.
- Do GP 6.2.7 to note the total machine bind and sheet cycles.
- If possible, run a bind cycle and evaluate the quality of the bound book. Refer to Section 3 of this manual for additional information regarding the book quality.
- Do GP 6.8 and GP 6.7 to replace the supply spool and re-evaluate the performance using the new supply spool.
- Determine the date of the last preventative maintenance performed on the system. Perform preventative maintenance as indicated on page 1-5.
- Vacuum the paper path, element feeder, and book stacking areas. Visually inspect the eWire and clear any scraps/debris.
- Save the system settings to a data file.
- Download a log file to USB. Note any error codes, especially if they occur repeatedly.

## SYSTEM CHECKS

### Purpose

Direct repair activity for problems found in Initial Action.

### PROCEDURE

- Select the appropriate condition from the list below and perform the directed service actions.
  - Replace any obviously broken parts.
  - If there is a Book Quality problem but no Fault Codes or other obvious problems, go to Section 3.
  - If there is a Fault Code, go to Section 2 Table of Contents. Locate and perform the RAP associated with the code.
  - If there is an Operator Message that will not clear, go to Section 2 Table of Contents. Locate and perform the steps in the OPERATOR MESSAGE RAP associated with the Operator Message.
  - If the problem is not repeatable, operate the eWire in the same job conditions the customer used and recheck for a problem in the categories listed here.
  - If the problem is still not reproduced, examine the Machine Service Log and note any repeating faults. Refer to the RAP for those faults in Section 2 to check if the RAP relates to the customer problem. If so, perform the RAP.
  - If general problems occur that are not related to any fault code, repeat the steps in install section.
  - If the problem is not resolved after 2 hours, escalate to Canon 2<sup>nd</sup> level support.
  - If none of the above situations apply, go to EVERY CALL ACTIVITIES.
- Verify that the problem is corrected and go to EVERY CALL ACTIVITIES.

## EVERY CALL ACTIVITIES

### Purpose

List service activities required on every service call.

### PROCEDURE

- Perform GP 6.10 Internal Inspection.
- Perform GP 6.11 External Cleaning.
- Perform GP 6.12 Internal Cleaning
- Perform GP 6.13 Base Cleaning
- Perform GP 6.15 Optical Sensor Cleaning

## SCHEDULED MAINTENANCE

### PROCEDURE

- Check the number of Bind Cycles and Sheet Cycles in the eWire Settings. Refer to GP 6.2.7.

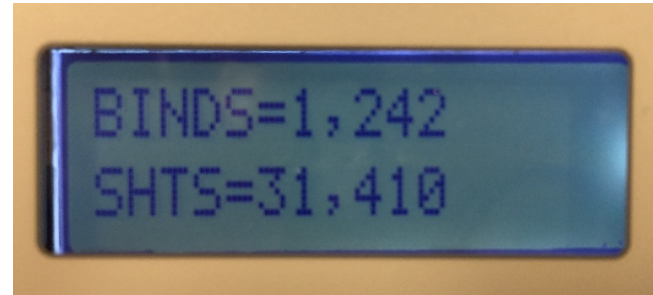

- Refer to the eWire Maintenance Schedule on Page 1-5. Perform all scheduled maintenance.
- Replace wear components as indicated in the Periodic Maintenance section of this document.

## eWIRE MAINTENANCE SCHEDULE

### Periodic Maintenance

Area/Unit	Period	Measures	Remarks
Drag Finger and Closer Pusher	1M sheets	Inspect and Clean	Alcohol & Cloth, see GP 6.10
Stacker Module Green Belt	1M sheets	Inspect and Clean	Alcohol & Cloth, see GP 6.10
Bypass Transfer Idler Rollers	1M sheets	Inspect and Clean	Alcohol & Cloth, see GP 6.14.1
Deflector Module Idler Rollers	1M sheets	Inspect and Clean	Alcohol & Cloth, see GP 6.14.1
Steering Module Idler Rollers	1M sheets	Inspect and Clean	Alcohol & Cloth, see GP 6.10
Element Feeder Belt	1M sheets	Inspect	See GP 6.10
Element Detect Flapper Sensor	1M sheets	Inspect and Clean, Ensure Free Movement	Clean area with vacuum or compressed air. See GP 6.13
Element Alignment at Stack Position	1M sheets	Inspect	Perform ADJ 1.10
Book Drawer Belt	1M sheets	Inspect	See GP 6.17
Kick Downs	1M sheets	Inspect	See GP 6.10
Paper Path and Other Sensors	1M Sheets	Inspect & Clean	Anti-static wipes. Note use an Anti-static cleaning wipe (7718648 PL 5.30) If these are not available use a dry cloth or canned air. Do not use alcohol or detergents. See GP 6.15
Closer Transport Rail	1M sheets	Clean and then Oil	Wipe rails with alcohol & cloth and then rub a few drops of light machine oil on each rail. See GP 3.19
Closer Chain	1M sheets	Clean and then Grease	Apply Grease and wipe away excess

### Periodic Replacement

Area/Unit	Period	See:	Measures	Remarks
Knife/Anvil	50,000 books	REP 3.14.3	Replacement	PL 5.11
Stacker Module, Kick Downs	4M Sheets	REP 4.7	Replacement	PL 5.15
Vacuum Stacker	12M sheets	REP 4.1	Replacement	PL 5.14
Closer Jaw Plates	50,000 binds	REP 6.5	Replacement	PL 5.19
Element Feeder Belt	100,000 binds	Rep 3.6	Replacement	PL 5.8

## **FINAL ACTION**

This section explains the actions a technician should take at the end of every service call. With each step, verify that the system runs smoothly and jam free.

### **Purpose**

Ensure machine performance and book quality are satisfactory and complete administrative tasks.

### **Procedure**

- Clear the Book Tray and install a Supply Spool of the size the customer was using when the problem initially occurred.
- Install/close all covers and doors.
- Run the eWire using the same settings as the customer was using when the problem occurred. If necessary, run a variety of different paper and spool size configurations to capture different configurations that may have been present during the failure.
- Carefully monitor the machine during the test run and make a note of any unusual observations. Listen for any unusual or excessive noise produced during operation.
- Explain to the customer the service work that was performed and ensure they are satisfied before you close the call.

### **Service Call Close**

- Record your service activities along with the BIND and SHEET counts.



## 2. Repair & Troubleshooting Procedures (RTPS)

### Section Contents

<b>Section 1.01 Introduction.....</b>	<b>2-3</b>
Entry RTP .....	2-3
<b>Section 1.02 OPERATOR MESSAGES.....</b>	<b>2-4</b>
a) Top Row of Text .....	2-4
b) Bottom Row of Text .....	2-4
c) Book Tray Full.....	2-5
d) Close Tray .....	2-6
e) Add Elements .....	2-7
f) Close Door.....	2-7
g) Close Cover .....	2-8
<b>Section 1.03 FAULT CODES .....</b>	<b>2-10</b>
a) Fault Code Text .....	2-10
b) Fault Code Areas.....	2-10
c) Jam Code Classifications .....	2-11
<b>2 POWER FAULTS.....</b>	<b>2-13</b>
RTP 2.1 No AC Power.....	2-13
RTP 2.2 No DC Power .....	2-15
RTP 2.3 Operator Panel Does Not Illuminate .....	2-17
RTP 2.4 Operator Panel Does Not Show Text.....	2-18
RTP 2.5 Up, Down, Enter Keys Do Not Respond .....	2-19
RTP 2.6 Close Door, Tray, Cover Message When All Are Closed	2-19
<b>3 PAPER TRANSPORT JAM CODES – J1xx and J2xx .....</b>	<b>2-20</b>
RTP 3.1 J244- UNBOUND BOOK PRESENT IN COLLECTION TRAY .....	2-20
RTP 3.2 J260- NO LEAD EDGE AT SKEW SENSOR DETECTED.....	2-20
RTP 3.3 Paper jam in transport.....	2-21
RTP 3.4 Jammed sheets in the Stacker module.....	2-26
<b>4 WIRE JAM CODES.....</b>	<b>2-27</b>
RTP 4.1 J320- S20 SPOOL ELEMENT SLACK TIMEOUT .....	2-27

Title	Page
RTP 4.2 J321- S21 LEAD EDGE DETECT TIMEOUT.....	2-28
RTP 4.3 J322- S22 ELEMENT AT PYRAMID TIMEOUT.....	2-29
RTP 4.4 J323- S23 KNIFE HOME TIMEOUT .....	2-30
RTP 4.5 J324- S24 PUSHOVER HOME TIMEOUT .....	2-30
RTP 4.6 J325- S25 FEED BELT HOME TIMEOUT .....	2-31
RTP 4.7 J332- S32 EXPAND T HOME TIMEOUT .....	2-32
RTP 4.8 J333- S33 EXPAND T OUT TIMEOUT .....	2-33
RTP 4.9 J334- FEED BELT JAM.....	2-34
RTP 4.10 J350- SPOOL NEAR EMPTY.....	2-35
RTP 4.11 J351- S32 & S33 BOTH BLOCKED .....	2-36
RTP 4.12 J361- RESIDUAL ELEMENT ERROR .....	2-36
RTP 4.13 J362- ELEMENT FAILED TO CUT .....	2-37
RTP 4.14 J363- FEED BELT HOME STEPS TIMEOUT .....	2-38
RTP 4.15 J364- M9 ELEMENT BACKUP STEPS TIMEOUT .....	2-39
RTP 4.16 J365- M9 MESH STEPS TIMEOUT .....	2-40
RTP 4.17 J366- ELEMENT AT PUSHOVER STEPS TIMEOUT .....	2-41
RTP 4.18 J367- ELEMENT STEPS TIMEOUT .....	2-41
RTP 4.19 J368- PUSHOVER FWD ENCODER TIMEOUT .....	2-42
<b>5 BIND JAM CODES .....</b>	<b>2-43</b>
RTP 5.1 J370- HOLDER AT S37 TIMEOUT .....	2-43
RTP 5.2 J371- S38 HOLDER POSITION ELEMENT TIMEOUT .....	2-44
RTP 5.3 J372- S39 DETECT AT REV GATE TIMEOUT .....	2-46
RTP 5.4 J373- S40 AT BOOK DROP POSITION TIMEOUT .....	2-48
RTP 5.5 J374- S46 BOOK DROP TIMEOUT .....	2-49
RTP 5.6 J375- BOOK DROP POSITION TIMEOUT .....	2-51
RTP 5.7 J376- CLOSER AT HOLDER STEPS TIMEOUT .....	2-51
RTP 5.8 J377- CLOSER CARRIAGE HOME TIMEOUT .....	2-52
RTP 5.9 J379- CLOSER JAWS HOME ENCODER TIMEOUT .....	2-52
RTP 5.10 J380- CLOSER JAWS HOME TIMEOUT.....	2-52

RTP 5.11	J381- CLOSER STAGED TIMEOUT .....	2-54
RTP 5.12	J382- FULL CLOSE TIMEOUT .....	2-54
RTP 5.13	J383- FULL OPEN TIMEOUT .....	2-54
RTP 5.14	J384- HOLDER AT CLOSER STEPS TIMEOUT.....	2-55
RTP 5.15	J385- HOLDER DETECT AT GATE TIMEOUT .....	2-55
RTP 5.16	J386- HOLDER FULL RIGHT TIMEOUT .....	2-57
RTP 5.17	J387- HOLDER HOME TIMEOUT .....	2-59
RTP 5.18	J388- HOLDER NOT HOME TIMEOUT .....	2-59
RTP 5.19	J389- HOLDER PAST HOME TIMEOUT.....	2-60
RTP 5.20	J390- HOLDER ROTATE HORIZONTAL TIMEOUT .....	2-60
RTP 5.21	J391- HOLDER ROTATE VERTICAL TIMEOUT.....	2-62
RTP 5.22	J392- HOLDER STACK POSITION STEPS TIMEOUT...	2-64
RTP 5.23	J393- HOLDER WAIT VERTICAL TIMEOUT .....	2-65
RTP 5.24	J394- PARTIAL CLOSE TIMEOUT .....	2-65
RTP 5.25	J395- S28 MOTOR STEPS TIMEOUT .....	2-66
RTP 5.26	J396- CLOSER RE-HOME ENCODER TIMEOUT .....	2-66
<b>6</b>	<b>BOOK DRAWER FAULT CODES.....</b>	<b>2-69</b>
RTP 6.1	J442- DRAWER FULL UP TIMEOUT .....	2-69
RTP 6.2	J443- DRAWER FULL DOWN TIMEOUT.....	2-70
RTP 6.3	J445- BOOK DRAWER FULL .....	2-71
RTP 6.4	J451- S42 & S43 BLOCKED AT SAME TIME .....	2-71
RTP 6.5	J452- BOOK DRAWER OPENED DURING JOB .....	2-72

## Section 1.01 Introduction

This section contains the Repair and Troubleshooting Procedures (RTPs).

### Organization

This section lists the Repair and Troubleshooting Procedure (RTP) for each Operator Message and Fault Code. In some cases, one Repair and Troubleshooting Procedure may apply to several Fault Codes. In those cases, subsequent Fault Codes include a cross reference to the pertinent RTP.

To help you locate each component, the Repair and Troubleshooting Procedures include part locators (PL 5.X) that refer to the pertinent page in Section 5, Part List.

### Entry RTP

Always do this RTP first.

Attempt to retrieve the number of Bind cycles and Sheet cycles (GP 6.2.7) and note it down.

1. If the customer says that they have a book quality problem, go to Section 3.
2. For the entire printing device- Power off, then power on (POPO). Check that eWire runs properly in all modes.

#### **eWire runs properly.**

**Y N**

Go to Step 3.

Go to INITIAL ACTION in Section 1.

3. Check the top row of text on the Operator Interface to determine if there is there an operator message.

#### **There is an operator message on line 1.**

**Y N**

Go to Step 4.

Go to the Table of Contents for Section 2 and locate the RTP for that status message.

4. Check the top row of text on the Operator Interface to determine if there is there an Error Code.

#### **There is an Error Code on line 1.**

**Y N**

Go to Step 5.

Go to the Table of Contents for Section 2 and locate the RTP for that fault code.

5. Check the top row of text on the Operator Interface to determine if there is there a Fault Code.

#### **There is a Fault Code on line 1.**

**Y N**

Go to Step 6.

Go to the Table of Contents for Section 2 and locate the RTP for that fault code.

6. Is there a Power Fault (No AC Power, No DC Power, No power to Control Board, Operator Panel Does Not Illuminate)?

#### **There is a Power Fault.**

**Y N**

Go to Step 7.

Go to the Table of Contents for Section 2 and locate the RTP for that power fault.

7. Can the operator use the Operator Interface to operate the equipment?

#### **The operator can use the Operator Interface to operate the equipment.**

**Y N**

Check with the customer to determine what symptom they have. Go to the Table of Contents for Section 2 and find the RTP that most closely fits the customer's description of the problem.

Go to INITIAL ACTION in Section 1.

## Section 1.02 OPERATOR MESSAGES

The Operator Panel displays status messages and fault codes on two rows of text.

READY
TO BIND

### a) Top Row of Text

Message	Description	Action
BOOK TRAY FULL	The Book tray is Full	Empty the Book tray
CLOSE TRAY	The Book tray is pulled out	Insert the Book tray
READY	The eWire is ready for Operation	n/a

### b) Bottom Row of Text

Message	Description	Action
ADD ELEMENTS	Element spool is almost empty/ not present	Replace the element spool with a new one.
CLOSE DOOR	Door for Element feeder drawer is opened	Insert the Element feeder drawer and close the door
CLOSE COVER	Top cover is open	Close the Top cover
TO BIND	eWire is in Bind mode	Use eWire in Bind mode

### c) Book Tray Full

The BOOK TRAY FULL message indicates that the book tray capacity has been reached and the tray needs to be emptied.

1. Open the Book drawer by pulling the drawer out.
2. Remove all the bound books from the tray. Note that all the books need to be removed to clear this message.
3. Re-insert the book drawer.

**This clears the fault code.**

Y N

| Go to step 4.

Normal operation.

4. Do GP 6.4 to check Sensor 42 Sensor 43 & Sensor 45 Book drawer Full. Remove any debris or obstructions..

**This clears the fault code.**

Y N

| Go to step 5.

Normal operation.

5. Do GP 6.5.10 to check Motor 19 Drawer elevation motor

**This clears the fault code.**

Y N

| Go to step 6.

Normal operation.

6. Inspect the pulley lift mechanism for the Book Drawer. Repair or replace any damaged components.

**This clears the fault code.**

Y N

| Go to step 7.

Normal operation.

7. Do GP 6.3.5 to re-flash the firmware.

**This clears the fault code.**

Y N

| Go to step 8

Normal operation

8. Replace Control board "B" (REP 11.2)

**This clears the fault code.**

Y N

| Escalate to second level.

Normal operation.

#### d) Close Tray

The CLOSE TRAY message indicates that the Book drawer is open or not completely closed.

1. Check that the Book drawer is closed

**The Book drawer is closed.**

Y N

| Close the Book drawer and return to normal operation.

2. Insert an Interlock Cheater into the Book drawer interlock Switch.

#### **WARNING**

**Moving Parts, keep hands clear of nips and the belts when the Interlock Cheater is inserted. See Section 0, page vii for other languages.**

3. Check if the Close Tray message is displayed.

**The Close Tray message is displayed.**

N Y

| Do ADJ 1.7 Book drawer interlock switch adjustment and return to normal operation

Go to Step 4.

4. Do REP 1.5 to remove the Rear Cover and check if the Interlock Jumper Cable 7718556 (See Section 7, page 7-2) is connected at J2 at the "B" Main Control Board.

**Interlock Jumper Cable is connected at J2.**

Y N

| Make the connection and return to normal operation.

5. Check if the Interlock Cable 7716715 (See Section 7, page 7-2) is connected at J18 at the "A" Main Control Board.

**Interlock Cable is connected at J18.**

Y N

| Make the connection and return to normal operation.

6. Switch OFF the machine and unplug the Power Cord.

7. Remove the M4 screws that hold the Interlock Switch Bracket (PL 5.25) and inspect the connections at the Interlock Switch (see REP 9.2 Interlock switch replacement for photos of the connections).

**Interlock cable is connected at the Interlock switch.**

Y N

| Make the connection and return to Normal operation

Go to step 8.

8. Do GP 6.3.5 Firmware Upgrade procedure to re-flash the Firmware

**Re-flashing the firmware clears the fault.**

Y N

| Go to Step 9.

Return to normal operation.

9. Do REP 9.2 Book drawer Interlock Switch Replacement to replace the Interlock switch.

**Replacing the switch clears the fault.**

Y N

| Go to Step 10.

Return to normal operation.

10. Replace Interlock Jumper Cable 7718556.

**Replacing the Jumper clears the fault.**

Y N

| Go to Step 11.

Return to normal operation.

11. Replace Interlock Switch Cable 7716715.

**Replacing the cable clears the fault.**

Y N

| Go to Step 12.

Return to normal operation.

12. Replace the "A" Main Control Board (REP 11.1).

**Replacing the board clears the fault.**

Y N

| Escalate to second level.

Return to normal operation.

### e) Add Elements

This message is displayed when the Element spool is removed from the machine or when the Element spool is low on elements.

Use this procedure when the Add Elements message is displayed when the Element spool containing elements is present in the machine.

1. Open the Element drawer door, remove the Element spool and reinstall the spool.

**This clears the fault.**

Y N

| Go to Step 2.

Return to normal operation

2. Inspect if the Element spool barcode label is damaged, missing or not centered on the hole

**Bar code label is damaged or missing**

Y N

| Go to Step 3.

Replace the spool with a new one and return to normal operation

3. Replace the element spool with another one. This is to troubleshoot the error, so try any available size.

**Replacing the Element spool clears the fault.**

Y N

| Go to Step 3.

Return to normal operation

4. Do GP 6.4.5 to inspect S26 to S30, and S50

**This clears the fault..**

Y N

| Escalate to second level

Return to normal operation.

### f) Close Door

This message is displayed when the Door for the element feeder module is left open or not properly closed.

1. Open the door, pull out the Element drawer and reinsert firmly.

**This clears the fault**

Y N

| Go to Step 2.

Return to normal operation

2. Insert an Interlock Cheater into the Book drawer interlock Switch.

### WARNING

**Moving Parts, keep hands clear of nips and the belts when the Interlock Cheater is inserted. See Section 0, page vii for other languages.**

3. Check if the Close Door message is displayed.

**The Close Door message is displayed**

N Y

| Do ADJ 1.7 Element Feeder door interlock switch adjustment.

Go to Step 4.

4. Do REP 1.5 to remove the Rear Cover and check if the Interlock cable 7716714 is connected at J9 at the "A" Main control board.

**Interlock cable is connected at J9**

Y N

| Replace the cable and repeat Step 1.

5. Switch OFF machine and unplug power cord.

6. Remove the M4 screws that hold the Interlock Switch Bracket (PL 5.25) and inspect the connections at the Interlock Switch (see REP 9.2 Interlock switch replacement for photos of the connections).

**Interlock cable is connected at the Interlock switch.**

Y N

| Make the connection and return to Normal operation

Go to step 7.

7. Do GP 6.3.5 Firmware Upgrade procedure to re-flash the Firmware

**Re-flashing the firmware clears the fault.**

Y N

| Go to Step 8.

Return to normal operation.

8. Do REP 9.2 Element drawer Interlock Switch Replacement to replace the Interlock switch.

**Replacing the switch clears the fault.**

Y N

| Go to Step 9.

Return to normal operation.

9. Replace Interlock Switch Cable 7716714.

**Replacing the cable clears the fault.**

Y N

| Go to Step 10.

Return to normal operation.

10. Do REP 11.1 to replace the Main Control Board A.

**Replacing the Main Board clears the fault.**

Y N

| Escalate to second level.

Return to normal operation.

**g) Close Cover**

This message is displayed when the Top Cover is left open or not properly closed.

1. Open the Top cover and close it firmly

**This clears the fault**

Y N

| Go to Step 2.

Return to normal operation

2. Insert an Interlock Cheater into the Top cover interlock Switch.

**WARNING**

**Moving Parts, keep hands clear of nips and the belts when the Interlock Cheater is inserted. See Section 0, page vii for other languages.**

3. Check if the Close Cover message is displayed.

**The Close Cover message is displayed**

N Y

| Do ADJ 1.19 Top Cover interlock switch adjustment

Go to Step 4.

4. Do REP 1.5 to remove the Rear Cover and check if the Interlock cable 7716716 is connected at J6 at the "A" Main control board.

**Interlock cable is connected at J6**

Y N

| Go to Step 5

5. Switch OFF machine and unplug power cord.

6. Remove the M4 screws that hold the Interlock Switch Bracket (PL 5.1) and inspect the connections at the Interlock Switch (see REP 9.2 Interlock switch replacement for photos of the connections).

**Interlock cable is connected at the Interlock switch.**

Y N

| Make the connection and return to Normal operation

Go to step 7.



7. Do GP 6.3.5 Firmware Upgrade procedure to re-flash the Firmware  
**Re-flashing the firmware clears the fault.**

Y N

| Go to Step 8.

Return to normal operation.

8. Do REP 9.1 Top cover Interlock Switch Replacement to replace the Interlock switch

**Replacing the switch clears the fault.**

Y N

| Go to Step 9.

Return to normal operation.

9. Replace Interlock Switch Cable 7716716.

**Replacing the cable clears the fault.**

Y N

| Go to Step 10.

Return to normal operation.

10. Do REP 11.1 to replace the Main Control Board A. (PL5.27)

**Replacing the Main Board clears the fault.**

Y N

| Escalate to second level.

Return to normal operation.

### Section 1.03 FAULT CODES

The User Interface displays Fault codes on two rows of text.

<b>PAPER JAM J203</b>
<b>CLEAR 2</b>

The top row of text displays the fault code.

The bottom row of text displays the area of the machine where the error occurred.

#### a) Fault Code Text

Each Fault code starts with the letter “J” followed by a 3-digit code.

#### b) Fault Code Areas

Fault Code areas are identified in the image below

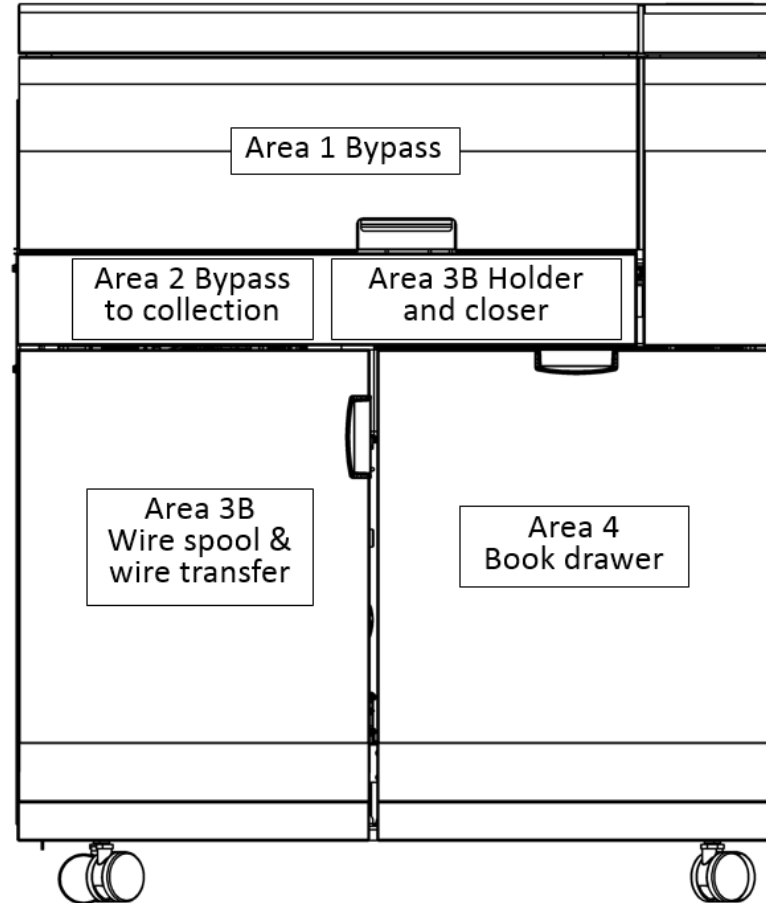

Bottom Row of Text	Area	General Location
Clear 1	Area 1	Bypass Section
Clear 2	Area 2	Bypass to Collection tray
Clear 3	Area 3a/3b	Wire spool, transfer, holder or closer
Clear 4	Area 4	Book drawer

c) **Jam Code Classifications**

The following table lists each jam type.

<b>Jam Type</b>	Description	<b>RTP</b>
<b>Jam 1xx</b>	Paper transport jam- Paper transport module, Entrance and Exit Extension	Do RTP 3.x
<b>Jam 2xx</b>	Paper transport jam- Paper transport module	Do RTP 3.x
<b>Jam 32x</b> <b>Jam 33x</b> <b>Jam 35x</b> <b>Jam 36x</b>	Wire jam- Element feeder module	Do RTP 4.x
<b>Jam 37x</b> <b>Jam 38x</b> <b>Jam 39x</b>	Bind jam- Closer module; Holder module	Do RTP 4.x
<b>Jam 4xx</b>	Book drawer jam- Book drawer module	Do RTP 5.x

Continued on the next page

The following table lists further details on paper jam types. It lists Jam Area and the corresponding description (position of first jammed sheet).

<b>Paper Jam Codes</b>	<b>Description</b>	<b>Area</b>	<b>RTP</b>
J101	First sheet located at S1	1	3.3.1
J202	First sheet located at S2	2	3.3.4
J203	First sheet located at S3	2	3.3.4
J104	First sheet located at S4	1	
J105	First sheet located at S5	1	
J106	First sheet located at S6	1	3.3.1
J107	First sheet located at S7	1	3.3.1
J108	First sheet located at S8	1	3.3.1
J109	First sheet located at S9	1	3.3.1
J110	First sheet located at S10	1	3.3.1
J112	First sheet located at S12	1	3.3.2
J113	First sheet located at S13	1	3.3.2
J115	First sheet located at S15	1	3.3.2
J116	First sheet located at S16	1	
J244	Unbound book present in collation tray	2	3.1
J260	No lead edge at skew sensors detected	1	3.2
J261	Sheet too far out of alignment on entering eWire	1	3.3.2

## 2 POWER FAULTS

### RTP 2.1 No AC Power

Use this RTP when there is no AC power to the eWire. The Operator Panel does not illuminate and the eWire does not operate. Check if the LEDs on the Main Control Board A and Main Control Board B are lit.

1. Ensure the Power is ON for the print engine, punch and eWire. The Power switch is located at the rear side of the machine.

**Main Power Switch is in the On (I) position**

Y N

┆ Place the Main Power Switch in the On (I) position.

2. Check that the Power Cord is attached to the AC Filter on the rear of the machine.

**Power Cord is attached to AC Filter.**

Y N

┆ Attach the Power Cord.

3. Check that the Power Cord is properly plugged into the wall.

**Power Cord is plugged into the wall.**

Y N

┆ Plug in the Power Cord.

4. Disconnect the Power Cord from the power source and check the power source voltage - 110 VAC (60 Hz) or 240 VAC (50 Hz) - at the power receptacle.

**AC power is present at correct value at the receptacle.**

Y N

┆ If there is no power at the outlet, ask the customer to call an electrician to restore the AC power.

5. Reconnect the power cord to the eWire.
6. Do REP 1.5 to remove the Rear Cover.
7. Check that Ground Wire 7715525 (See Section 7, page 7-2) is connected to the ground and to the AC Filter.

**Ground Wire is connected.**

Y N

┆ Connect Ground Wire.

Go to step 8

8. Check that Cable 7716727 (See Section 7, page 7-2) is connected at the AC Filter and the Power switch SW1 at the other end

**Cable 7716727 (Black/White) is connected at both ends**

Y N

┆ Connect Cable 7716727

9. Check that Cable 7716729 (See Section 7, page 7-2) is connected to the Power Switch at one end and at the input terminals of the 24 VDC Power Supply at the other end.

**Cable 7716729 (Black/White) is connected at both ends**

Y N

┆ Connect Cable 7716729

10. Check that Cable 7716726 (See Section 7, page 7-2) is connected to the 24 VDC power supply and the Main Board A.

**Cable 7716726 is connected.**

Y N

┆ Connect Cable 7716726

11. Check for input voltage - 110 VAC (60 Hz) or 240 VAC (50 Hz) - at the AC Filter terminals.

**There is AC power at the AC Filter.**

Y N

┆ Replace the AC power cord to the AC Filter.

12. Check for continuity at the AC Power Switch (PL 5.27).

**There is continuity at the AC Power Switch.**

Y N

┆ Replace AC Power Switch 7704376 (REP 11.6)

13. Check for voltage - 110 VAC (60 Hz) or 240 VAC (50 Hz) – on Cable 7716728 (See Section 7, page 7-2) at the AC Filter.

**There is AC power on Cable 7716728 at the AC Filter.**

Y N

┆ Replace AC FILTER (REP 11.5).

14. Check for voltage - 110 VAC (60 Hz) or 240 VAC (50 Hz) – on Cable 7716729 (See Section 7, page 7-2).

**There is AC power on Cable 7716729.**

Y N

┆ Replace Cable 7716729

15. Check for output voltage – 24 VDC on Cable 7716726 at the 24 VDC power supply.

**There is DC power on Cable 7716726 at the Power Supply.**

**Y N**

Replace the 24 VDC power supply (REP 11.4)

Go to RTP 1.2 No DC Power

## RTP 2.2 No DC Power

Use this RTP when there is indication of interruption to DC power.

1. Do REP 1.5 to remove the Rear Cover.
2. Plug in the AC power cord and turn ON the AC power switch.

### WARNING

**Moving Parts, keep hands clear of nips and the belts when the Interlock Cheater is inserted. See Section 0, page vii for other languages.**

3. Check the LEDs on the Control Board.

“A” Main Control board

LED description	ON	OFF
+24V	When there is 24V DC power supply to the board	When there is no 24V DC power supply to the board
+24VI	When all the interlock switches are closed. (Top cover; Element drawer door; Book drawer)	When any one of the three interlock switches is open.
+5VDC	When the 5V DC regulator is working and is providing 5V to the sensors	When 5V DC regulator is not working
+3.3V DC	When the 3.3V DC regulator is working and is providing 3.3V to the processors	When 3.3V DC regulator is not working
OV! (Red color)	When there is over-voltage from 24V DC power supply	24V power supply is providing the correct voltage
REV POL! (Red color)	When the polarity of 24V DC wires is reversed	Polarity of the wires is correct
OK (Green color)	When the polarity of 24V DC wires is correct	Polarity of the wires is not correct

“B” Main control board

LED description	ON	OFF
24V	When there is 24V DC power supply to the board	When there is no 24V DC power supply to the board
24ViA	When all the interlock switches are closed. (Top cover; Element drawer door; Book drawer)	When any one of the three interlock switches is open.
24ViB	When all the interlock switches are closed. (Top cover; Element drawer door; Book drawer)	When any one of the three interlock switches is open.
+5VDC	When the 5V DC regulator is working and is providing 5V to the sensors	When 5V DC regulator is not working
+3.3V DC	When the 3.3V DC regulator is working and is providing 3.3V to the processors	When 3.3V DC regulator is not working

- With the cover/door/drawer closed, there will be (5) LEDs that will be lit on the “A” board and (5) LEDs lit on the “B” board
- With the cover/door/drawer open, there will be (4) LEDs that will be lit on the “A” board and (3) LEDs lit on the “B” board.

**The LEDs are lit as indicated.**

**Y N**

If LEDs of “A” board are not lit correctly, go to step 4.

If LEDs of “B” board are not lit, go to step 12.

Go to step 9.

4. If OV! LED (red color) is lit, go to Step 9
5. If REV POL! (red color) is lit, go to Step 7
6. Check for voltage – 110 VAC (60 Hz) or 240 VAC (50 Hz) – on Cable 7716729 (See Section 7, page 7-2) at the 24 VDC Power Supply.

**There is AC power on Cable 7716729.**

**There is line voltage.**

**Y N**

| Do RTP 2.1 No AC Power.

7. Check the following connections (See Section 7, page 7-2):
- Connection of cable 7716726 at J1 at the Main Control Board.
  - Connection of cable 7716726 at the 24V DC power supply
    - Input; Line "L"- Black wire
    - Input; Neutral "N"- White wire
    - Input; Ground- Green wire
    - Output; +24VDC – Orange wire
    - Output; 0 VDC – Black wire

**Connections are good.**

**Y N**

| Make the connections then return to normal operation.

8. Check if the LED in the 24 VDC power supply is lit

**LED is lit**

**Y N**

| Go to RTP 2.1 No AC Power.

9. Check for 24 VDC on Cable 7716726 (See Section 7, page 7-2) at Connector J1 on the "A" Main Control board
- Pin 1 = BLK Wire
  - Pin 2 = BLK Wire
  - Pin 3 = BLK Wire
  - Pin 4 = BLK wire
  - Pin 5 = ORG wire
  - Pin 6 = ORG Wire
  - Pin 7 = ORG Wire
  - Pin 8 = ORG Wire

**There is 24 VDC at Connector J1 on the Control Board**

**Y N**

| Go to Step 10

Replace 24V DC power supply (REP 11.3)

10. Replace Cable 7716726.

**This clears the fault.**

**Y N**

| Go to Step 11

Return to normal operation

11. Check if there is 24V power to any other components like a Solenoid, or a Stepper Motor.

**There is no 24V power to any other components**

**Y N**

| Go to Step 12

Replace the "AC" Main Control board (REP 11.1)

12. Check if cable 7716735 is connected at J15 of the "A" Main control board and J1 of the "B" control board

**Connections are good**

**Y N**

| Make the connection and return to normal operation

13. Replace "B" Main Control board

**This clears the fault.**

**Y N**

| Go to Step 14

Return to normal operation

14. Replace Cable 7716735.

**This clears the fault.**

**Y N**

| Go to step 15 if applicable; otherwise escalate to second level

Return to normal operation

15. Determine if you have been directed here from another RTP because there is no 24 VDC power output from the Control Board to another component.

**There is no 24 VDC power output from the Control Board to another component.**

**Y N**

| Normal operation.

Replace the Main Control Board (REP 11.1)



### RTP 2.3 Operator Panel Does Not Illuminate

Use this RTP when the LCD Display does not illuminate.

1. Power OFF eWire.
2. Wait 20 seconds then power ON the device(s).  
The Operator Interface illuminates.  
**Y N**  
| Go to step 3.  
Normal operation.
3. Open the Front door. Check if the printer screen shows an eWire related fault.  
**Printer screen shows a eWire related fault**  
**Y N**  
| Go to step 4.  
Do RTP 2.2 No DC Power.
4. Do REP 1.5 to remove the Rear Cover.
5. Verify that the AC Power Cord is plugged in and turn on the Power Switch.

#### **WARNING**

**Do not perform repair activities with the power on or electrical power supplied to the machine. Some machine components contain dangerous electrical voltages that can result in electrical shock and possible serious injury. See Section 0, page vi for other languages.**

6. Check the LEDs on the Control Board.
  - With the cover/door/drawer closed, there will be (5) LEDs that will be lit on the “AC” board and (5) LEDs lit on the “B” board
  - With the cover/door/drawer open, there will be (4) LEDs that will be lit on the “AC” board and (3) LEDs lit on the “B” board.

**The LEDs are lit.**

- Y N**  
| Do RTP 2.2 No DC Power

7. Check that LCD Cable 7716713 is connected at Connector J42 of the “A” Main Control Board (See Section 7, page 7-2).

**Cable 7716713 is connected at Connector J42.**

- Y N**  
| Connect Cable 7716713 (See Section 7, page 7-2).  
Go to step 8.

8. Check that LCD Cable 7716713 (See Section 7, page 7-2) is connected at the LCD Panel on the rear of the User Interface (PL 5.1).

**Cable 7716713 is connected at the LCD Panel.**

- Y N**  
| Connect Cable 7716713 (See Section 7, page 7-2).

9. Check the condition of LCD Cable 7716713 (See Section 7, page 7-2).

**LCD Cable 7716713 is okay.**

- Y N**  
| Replace LCD Cable 7716713.

10. Replace the LCD Board 7715527 on the rear of the User Interface (PL 5.1)

**This clears the fault**

- Y N**  
| Escalate to 2<sup>nd</sup> level.

Return to normal operation

## RTP 2.4 Operator Panel Does Not Show Text

Use this RTP when the LCD Display does not show text but illuminates.

1. Power OFF eWire
2. Wait 20 seconds then power ON the device(s).  
The Operator Interface illuminates.  
**Y N**  
| Go to step 3.  
Normal operation.
3. Check that LCD Cable 7716713 is connected at Connector J42 on the Control Board (See Section 7, page 7-2).  
**Cable 7716713 is connected at Connector J42.**  
**Y N**  
| Connect Cable 7716713.
4. Check that LCD Cable 7716713 is connected at the LCD Panel on the rear of the User Interface (See Section 7, page 7-2 and PL 2.2).  
**Cable 7716713 is connected at the LCD Panel.**  
**Y N**  
| Connect Cable 7716713
5. Upload firmware: Do GP 6.3.5  
**The Operator Interface shows text.**  
**Y N**  
| Go to step 6.  
Normal operation.
6. Check the condition of LCD Cable 7716713 (See Section 7, page 7-2)  
**LCD Cable 7716713 is okay.**  
**Y N**  
Replace LCD Cable 7716713.  
Go to Step 7

7. Replace the LCD Board on the rear of the User Interface (REP 1.9)

### This clears the fault

**Y N**  
| Go to Step 8  
Normal operation.

8. Check LCD for normal operation.

### The Operator Interface shows text.

**Y N**  
| Replace Main Control Board A (REP 11.1).  
Normal operation.

### RTP 2.5 Up, Down, Enter Keys Do Not Respond

Use this RTP when the Up, Down, Enter Keys on the LCD Membrane switch do not respond.

1. Open the Top cover and remove the M4 fasteners (4) securing the LCD Tower Cover. Check that the flat cable from the LCD Panel is connected to the LCD Display (See Section 7, page 7-2).

**The Cable is connected.**

**Y N**  
| Connect the Cable.

Do REP 1.10 LCD Membrane switch replacement.

### RTP 2.6 Close Door, Tray, Cover Message When All Are Closed

Use this RTP when the message "CLOSE DOOR," "CLOSE TRAY," or "CLOSE COVER" is displayed when the corresponding door is closed.

1. Reopen and close all covers

**The message remains.**

**Y N**  
| Normal Operation

2. Do ADJ 1.7 Interlock Flag Adjustment and ADJ 1.19 Top Cover Latch Adjustment.

**The message remains.**

**Y N**  
| Normal Operation

3. Perform REP 9.1 or 9.2 to replace the corresponding interlock

**The message remains.**

**Y N**  
| Normal Operation  
Escalate to second level

### 3 PAPER TRANSPORT JAM CODES – J1xx and J2xx

#### RTP 3.1 J244- UNBOUND BOOK PRESENT IN COLLECTION TRAY

J244 occurs when a sheet or book is left over in the collection tray after it should have fallen into the book drawer.

1. Go to Book Quality Section 3.3 Sheets not Hooking and go through the instructions there

**This clears the fault**

**Yes-** Return to normal operation;

**No-** Escalate to second level.

#### RTP 3.2 J260- NO LEAD EDGE AT SKEW SENSOR DETECTED

J260 occurs when a sheet is detected at the entry sensor (S1) but not detected by the skew sensor (S6-S10).

1. Perform GP 6.4.2 Sensor check of S6-S10

**This clears the fault**

**Yes-** Return to normal operation;

**No-** Go to step 2

2. Ensure that the eWire is properly aligned with the upstream punch. Refer to Section 8, the installation manual for instructions.

**This clears the fault**

**Yes-** Return to normal operation;

**No-** Go to step 3

3. Perform RTP 3.5.2

**This clears the fault**

**Yes-** Return to normal operation;

**No-** Escalate to second level.

If a paper transport jam code J1xx or J2xx is displayed, determine the location of the first jammed sheet.

If the first jammed sheet is in the transport section, go to **RTP 3.5**

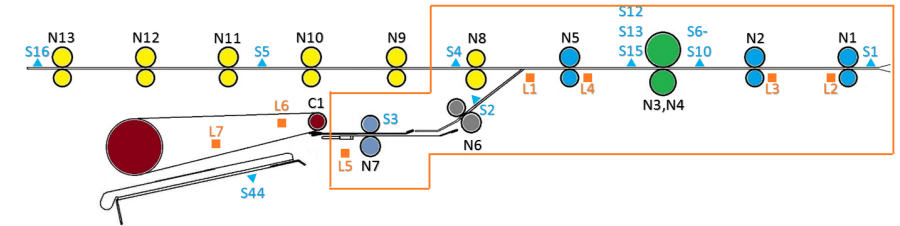

If the first jammed sheet is in the sheet stacking section, go to **RTP 3.6**

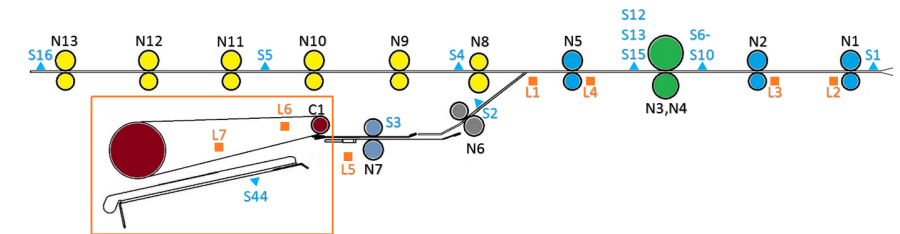

### RTP 3.3 Paper jam in transport

Use this RTP to troubleshoot paper jam in the transport section.

Depending on the location of the first jammed sheet, choose the appropriate RTP.

Location of the first jammed sheet is before the Steering module (rollers N4, N5)- Go to **RTP 3.3.1**

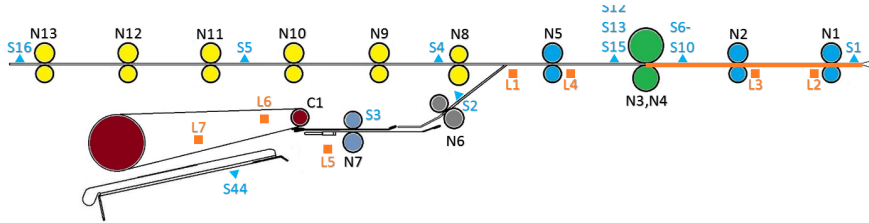

Location of the first jammed sheet is before the Diverter gate- Go to **RTP 3.3.2**

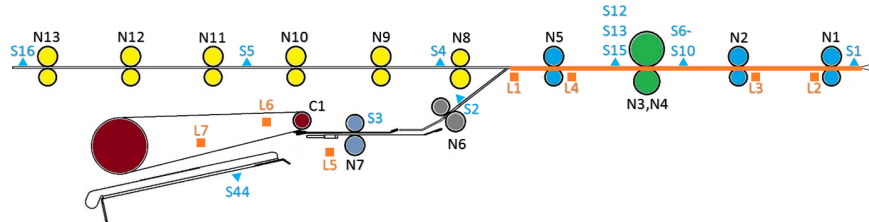

Location of the first jammed sheet is before the roller in the deflector module (N8)- Go to **RTP 3.3.3**

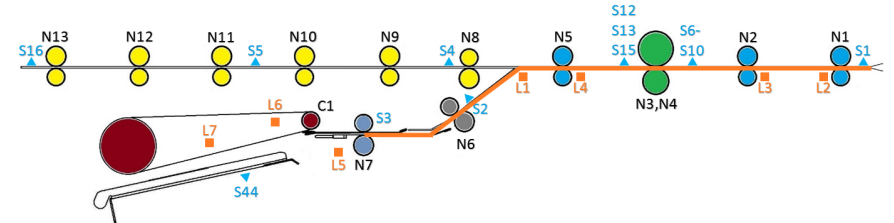

Location of the first jammed sheet is before the stacker module (before the green belt)- Go to **RTP 3.3.4**

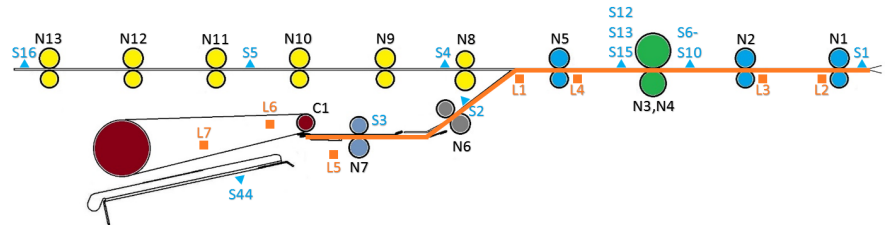

### RTP 3.3.1 First jammed sheet before Steering module

Follow the below procedure when the first jammed sheet is before the Steering module

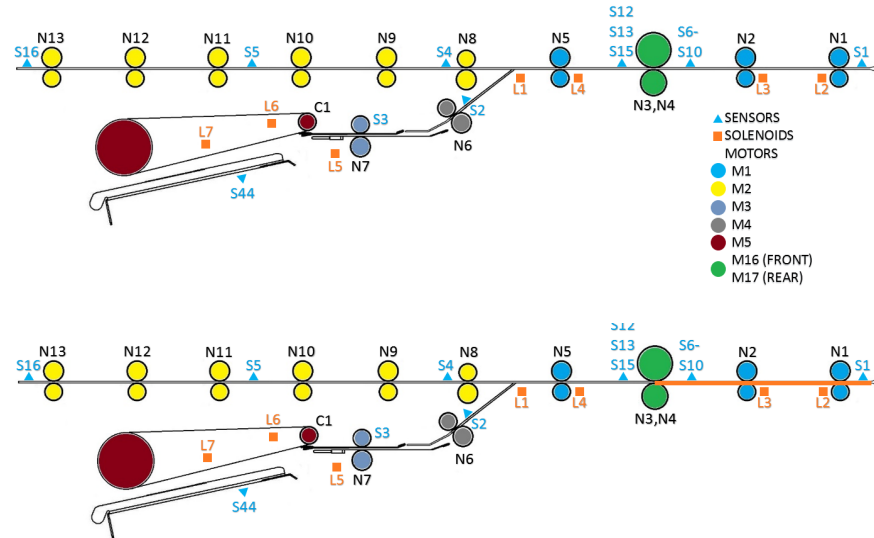

1. Raise the top cover and check for any obstructions in the paper path leading to the steering module  
**This clears the fault**  
**Yes-** Return to normal operation      **No-** Go to Step 2
2. Do GP 6.4.1 to check sensor S1  
**This clears the fault**  
**Yes-** Return to normal operation      **No-** Go to Step 3
3. Do GP 6.5.1 to check transport motor M1, M16 and M17.  
**This clears the fault**  
**Yes-** Return to normal operation      **No-** Go to Step 4

4. Inspect Solenoids L2 and L3 (GP 6.6.1)- ensure these solenoids are not disengaging the rollers N1 and N2 when not actuated. The rollers should extend past the metal plate, and should be even with the rest of the idler rollers on the Upper Transport.

**Rollers are not disengaged when L2 and L3 are not actuated**

**Yes-** Go to Step 5

**No-** If N1 does not engage and disengage, replace L2 (REP 2.19)  
 If N2 does not engage and disengage, replace L3 (REP 2.19)

5. Inspect rollers N1, N2 and N3- GP 6.14

**This clears the fault**

**Yes-** Return to normal operation

**No-** Go to Step 6

6. Inspect the paper transport latch, if necessary perform adjustment. Ensure the paper transport is securely closed.

**This clears the fault**

**Yes-** Return to normal operation

**No-** Go to Step 7

7. Inspect the transition from the entrance section to the Steering module section. The steering module lower panel and the Entrance section lower panel should be in line with each other.

**The panels are in line with each other**

**Yes-** Go to Step 8

**No-** Do REP 2.21 to remove and replace the Steering Module. Inspect the Steering Module for damage, and re-check the Steering Module after installation.

8. Do GP 6.3.5 FIRMWARE UPGRADE Procedure to Re-flash the firmware for eWire.

**This clears the fault**

**Yes-** Return to normal operation

**No-** Escalate to second level

### RTP 3.3.2 First jammed sheet before the Diverter gate

Follow the below procedure when the first jammed sheet is before the Diverter gate

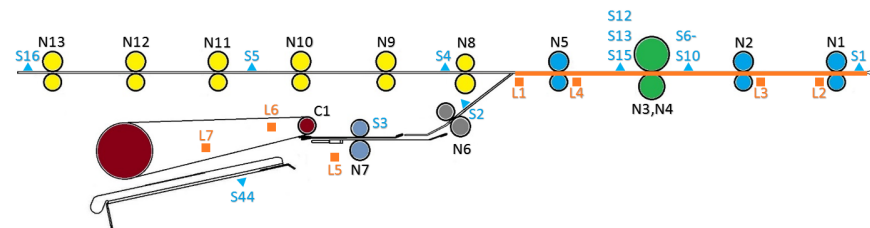
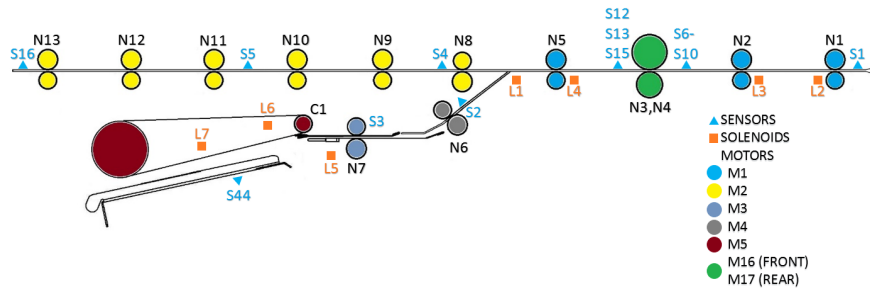

1. Inspect Diverter gate solenoid L1- GP 6.18.  
**This clears the fault**  
**Yes-** Return to normal operation      **No-** Go to Step 2
2. Check for any obstructions in the paper path leading to the diverter gate. Remove any obstruction.  
**This clears the fault**  
**Yes-** Return to normal operation      **No-** Go to Step 3
3. Do GP 6.4 to check sensor S1, S12, 13, 15, 6, 7, 8, 9, 10 and 41.  
**This clears the fault**  
**Yes-** Return to normal operation      **No-** Go to Step 4
4. Do GP 6.5 to check motors M1, M16, and M17.  
**This clears the fault**  
**Yes-** Return to normal operation      **No-** Go to Step 5

5. Do GP 6.6 to inspect solenoids L2, L3 and L4.  
**This clears the fault**  
**Yes-** Return to normal operation      **No-** Go to Step 6
6. Inspect rollers N1, N2, N3, N4, and N5- GP 6.14  
**This clears the fault**  
**Yes-** Return to normal operation      **No-** Go to Step 7
7. Inspect the paper transport latch, if necessary perform adjustment. Ensure the paper transport is securely closed.  
**This clears the fault**  
**Yes-** Return to normal operation      **No-** Go to Step 8
8. Inspect the transition from the Steering module section to the subsequent section. The steering module lower panel and transport module lower panel should be in line with each other.  
**The panels are in line with each other**  
**Yes-** Go to Step 9  
**No-** Using REP 6.21 Steering module replacement, make the necessary adjustments.
9. Do GP 6.3.5 FIRMWARE UPGRADE Procedure to Re-flash the firmware for eWire.  
**This clears the fault**  
**Yes-** Return to normal operation      **No-** Escalate to second level

### RTP 3.3.3 First jammed sheet before the deflector module

Follow the below procedure when the first jammed sheet is before the Deflector module

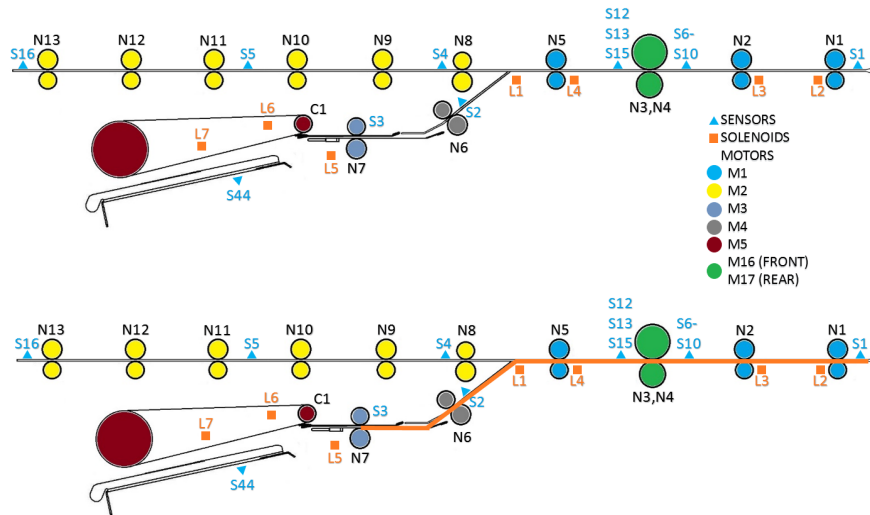

1. Check for any obstructions in the paper path leading to the deflector module

**This clears the fault**

**Yes-** Return to normal operation      **No-** Go to Step 2

2. Do GP 6.4 to check sensor S1, S12, 13, 15, 6, 7, 8, 9, 10, 41, 2 and 3.

**This clears the fault**

**Yes-** Return to normal operation      **No-** Go to Step 3

3. Do GP 6.5 to check motors M1, M16, M17, M18 and M3.

**This clears the fault**

**Yes-** Return to normal operation      **No-** Go to Step 4

4. Do GP 6.6 to inspect solenoids L2, L3 and L4.

**This clears the fault**

**Yes-** Return to normal operation      **No-** Go to Step 5

5. Inspect rollers N1, N2, N3, N4, N5, N6 and N7- GP 6.14

**This clears the fault**

**Yes-** Return to normal operation      **No-** Go to Step 6

6. Inspect the transition from the transport module section to the deflector module.

**The transition from transport module to deflector module is properly aligned**

**Yes-** Go to Step 7

**No-** Using REP 6.21 Replacing Steering module, make the necessary adjustments.

7. Do GP 6.3.5 FIRMWARE UPGRADE Procedure to Re-flash the firmware for eWire.

**This clears the fault**

**Yes-** Return to normal operation      **No-** Escalate to second level



### RTP 3.3.4 First jammed sheet before the Stacker module

Follow the below procedure when the first jammed sheet is before the Stacker module

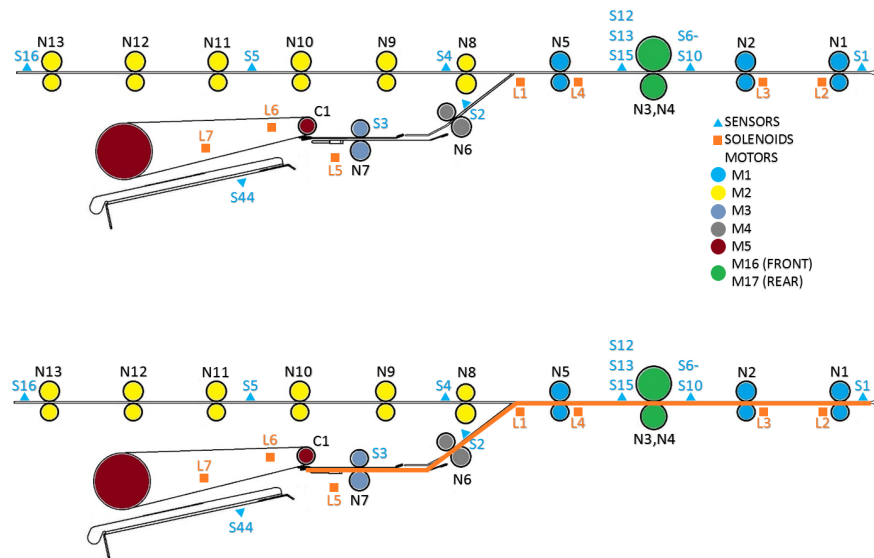

1. Check for any obstructions in the paper path leading to the deflector module

**This clears the fault**

**Yes-** Return to normal operation      **No-** Go to Step 2

2. Do GP 6.5 to check motor M3, M16, M17 and M18.

**This clears the fault**

**Yes-** Return to normal operation      **No-** Go to Step 3

3. Do GP 6.4 to check sensor S1, S12, 13, 15, 6, 7, 8, 9, 10, 41, 2 and 3.

**This clears the fault**

**Yes-** Return to normal operation      **No-** Go to Step 4

4. Do GP 6.6 to inspect solenoids L2, L3, L4, and L7.

**This clears the fault**

**Yes-** Return to normal operation      **No-** Go to Step 5

5. Inspect rollers N8, N1, N2, N3, N4, N5 and N6- GP 6.14

**This clears the fault**

**Yes-** Return to normal operation      **No-** Go to Step 6

6. Inspect the gap between the deflector and ensure there are no obstructions for smooth paper flow

**There are no obstructions**

**Yes-** Go to Step 7

**No-** Remove the obstruction, replace the Deflector module if necessary REP 5.1.

7. Go to Section 3 3.3 Sheets not Hooking and go through the instructions there

**This clears the fault**

**Yes-** Return to normal operation;

**No-** Go to Step 8.

8. Do GP 6.3.5 FIRMWARE UPGRADE Procedure to Re-flash the firmware for eWire

This clears the fault

**Yes-** Return to normal operation      **No-** Go to Step 9

9. Do REP 5.1 to replace the Deflector module

**This clears the fault**

**Yes-** Return to normal operation      **No-** Escalate to second level.

### RTP 3.4 Jammed sheets in the Stacker module

Use the below procedure if the first jammed sheet is in the Stacker module

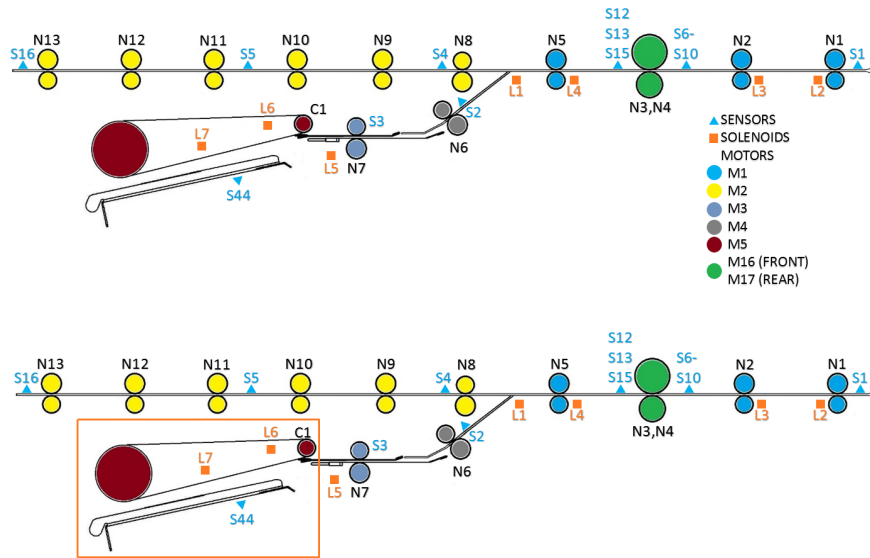

1. Refer to Section 3 to check if the holes are punched correctly by the punch. If there is a hole punch issue, refer to the punch troubleshooting to resolve it.

**This clears the fault**

**Yes-** Return to normal operation      **No-** Go to Step 2

2. Check for any obstructions in the paper path leading to the stacker module

**This clears the fault**

**Yes-** Return to normal operation      **No-** Go to Step 3

3. Do GP 6.4 to check sensor S2, S3, S12, S13, S15, S6, S7, S8, S9, S10 and S44.

**This clears the fault**

**Yes-** Return to normal operation      **No-** Go to Step 4

4. Do GP 6.5 to check motors M5, M3, M16, M17, M18 and M1.

**This clears the fault**

**Yes-** Return to normal operation      **No-** Go to Step 5

5. Do GP 6.6 to inspect solenoids L5, L6, L7, L2, L3 and L4.

**This clears the fault**

**Yes-** Return to normal operation      **No-** Go to Step 6

6. Make sure there is no damage to the element spool. If the element spool is damaged/deformed, the element tip will not be in the correct position for stacking. If necessary, do GP 6.7 to install a new spool.

**This clears the fault**

**Yes-** Return to normal operation      **No-** Go to Step 7

7. Inspect rollers N9, N8, N4, N5, N1, N2, N3 and N6- GP 6.14

**This clears the fault**

**Yes-** Return to normal operation      **No-** Go to Step 8

8. Go to Section 3 3.3 Sheets not Hooking and go through the instructions there

**This clears the fault**

**Yes-** Return to normal operation;

**No-** Go to Step 9

9. Do GP 6.3.5 FIRMWARE UPGRADE Procedure to Re-flash the firmware for eWire.

**This clears the fault**

**Yes-** Return to normal operation      **No-** 9Escalate to second level.

## 4 WIRE JAM CODES

### RTP 4.1 J320- S20 SPOOL ELEMENT SLACK TIMEOUT

S20 Element Slack time out is the maximum time to wait for S20\_Element\_Slack sensor to detect a wire.

1. Check if the rewind paper from the spool has been cut/damaged/slipped.  
**Rewind paper appears to be damaged/cut**  
**Yes-** Clear the Rewind Spool and reinsert the rewind paper. If paper repeatedly tears, do ADJ 1.21;  
**No-** Go to Step 2
2. Ensure that the element shield is properly installed and not rubbing against the spool. Ensure that the 2 studs on the shield are tight and are fully seated into the slots.  
**Shield is properly installed**  
**Yes –** Return to normal operation  
**No-** Go to step 3
3. Perform GP 6.13 to clean the base of the Element Feeder Drawer. Ensure that the Element Slack Detect Assembly moves freely without any obstruction.  
**This clears the fault**  
**Yes-** Return to normal operation;  
**No-** Go to step 4
4. Perform GP 6.7 and GP 6.8 to reinstall the Supply Spool.  
**Replacing the spool with a new one fixes the problem**  
**Yes-** Reinstall the correct size spool and continue operation;  
**No-** Go to Step 5
5. Do GP 6.4 to check S20 Element slack sensor.  
**This clears the fault**  
**Yes-** Return to normal operation;  
**No-** Go to Step 6
6. Do GP 6.5 to check M8 Spool rewind motor.  
**This clears the fault**  
**Yes-** Return to normal operation;  
**No-** Go to step 7
7. Check the Rewind Belt Pulley  
**Pulley is intact and has proper tension**  
**Yes-** Go to Step 8;  
**No-** Do REP 3.9 to replace the Pulley Assembly
8. Perform ADJ 1.2 Element Slack Detection Adjust.  
**This clears the fault**  
**Yes-** Return to normal operation;  
**No-** Go to Step 9;
9. Check the condition of Element Slack Detect Assembly (PL 5.10)  
**Element Slack Detect Assembly is in good condition**  
**Yes-** Go to Step 10;  
**No-** Do REP 3.18 to replace Element Slack Detect Assembly.
10. Do GP 6.3.5 FIRMWARE UPGRADE Procedure to Re-flash the latest firmware for eWire.  
**This clears the fault**  
**Yes-** Return to normal operation;  
**No-** Escalate to second level

## RTP 4.2 J321- S21 LEAD EDGE DETECT TIMEOUT

S21 Lead edge detect time out is the maximum time to wait for the lead edge of the element to reach the Knife.

1. Ensure that the element is placed properly onto the Element Feed Track. Use the label on the knife cover to position it.

**Element is located properly on the Element Feed Sprocket**

**Yes-** Go to Step 2

**No-** Load the element spool properly (GP 6.7)

2. Ensure that the element moves freely on the Element Feed Track when the Knob is turned by hand. If necessary, do GP 6.3.6 Functional Tests and run the Feed Element function. Ensure that the element moves feely on the Element Feed Track with no burrs or obstructions.

**Element moves freely on the Element Feed Track**

**Yes-** Go to Step 3

**No-** Remove the obstruction, or do REP 3.10 to replace the Element Feed Track. Properly load the spool with a fresh element if necessary.

3. Do GP 6.4 to check S21 Element Detect at Knife sensor  
This clears the fault

**Yes-** Return to normal operation

**No-** Go to step 4

4. Do GP 6.5 to check M9 Element feed sprocket motor

**This clears the fault**

**Yes-** Return to normal operation

**No-** Go to Step 5

5. Perform the steps in RTP 4.1 J320- S20 Spool Element Slack Timeout

**This clears the fault**

**Yes-** Return to normal operation

**No-** Escalate to second level

### RTP 4.3 J322- S22 ELEMENT AT PYRAMID TIMEOUT

S22 Element at Pyramid time out is the maximum time to wait for the lead edge of the element to reach the Element Detect at Pyramid sensor

1. Check if the element spool is loaded properly.  
**Element spool is loaded properly**  
**Yes-** Go to Step 2  
**No-** Remove the element spool and reinsert it properly
2. Do GP 6.4 to check S22 Element Detect at Pyramid sensor  
**This clears the fault**  
**Yes-** Return to normal operation  
**No-** Go to step 3
3. Check the condition of the Element belt (PL 5.8). Check for missing or loose teeth in the belt  
**Element belt is in good condition**  
**Yes-** Go to Step 4  
**No-** Replace the belt (REP 3.6)
4. Do ADJ 1.17 Element Feed Belt Tension Adjustment  
**This clears the fault**  
**Yes-** Return to normal operation  
**No-** Go to Step 5
5. Do GP 6.5 to check M10 Element feed belt Motor.  
**This clears the fault**  
**Yes-** Return to normal operation  
**No-** Go to step 6
6. Go GP 6.4 to check S25 Belt Home sensor  
**This clears the fault**  
**Yes-** Return to normal operation  
**No-** Go to step 7
7. Check the condition of the Element feed track assembly (PL 5.9)  
**Element feed track assembly is in good condition**  
**Yes-** Go to Step 8  
**No-** Replace Element feed track assembly (REP 3.10)
8. Check the condition of the Element feed belt idler assembly (PL 5.9)  
**Element feed belt idler assembly is in good condition**  
**Yes-** Go to Step 9  
**No-** Replace Element feed track assembly (REP 3.10)
9. Check the condition of the Element engagement guide (PL 5.9)  
**Element engagement guide is in good condition**  
**Yes-** Go to Step 10  
**No-** Replace Element engagement guide (REP 3.13)
10. Check the condition of the Element belt idler (PL 5.9)  
**Element belt idler is in good condition**  
**Yes-** Go to Step 11  
**No-** Replace Element belt idler (REP 3.11)
11. Check the condition of the Element sprocket nose sub-assembly (PL 5.9)  
**Element sprocket nose sub-assembly is in good condition**  
**Yes-** Go to Step 12  
**No-** Replace Element sprocket nose sub-assembly (REP 3.12)
12. Do GP 6.3.5 FIRMWARE UPGRADE Procedure to Re-flash the firmware for eWire.  
**This clears the fault**  
**Yes-** Return to normal operation;  
**No-** Escalate to second level

#### **RTP 4.4 J323- S23 KNIFE HOME TIMEOUT**

S23 Knife home time out is the maximum time to wait for the Knife to reach home.

1. Do GP 6.4 to check S23 Knife Home sensor.  
**This clears the fault**  
**Yes-** Return to normal operation  
**No-** Go to Step 2
2. Do GP 6.5 to check M11 Knife Motor  
**This clears the fault**  
**Yes-** Return to normal operation  
**No-** Go to step 3
3. Do GP 6.3.5 FIRMWARE UPGRADE Procedure to Re-flash the firmware for eWire.  
**This clears the fault**  
**Yes-** Return to normal operation;  
**No-** Go to Step 4
4. Replace the Knife module (REP 3.15)  
**This clears the fault**  
**Yes-** Return to normal operation  
**No-** Go to Step 5
5. Do REP 11.2 "B" Main Control Board Replacement.  
**This clears the fault**  
**Yes-** Return to normal operation;  
**No-** Escalate to second level

#### **RTP 4.5 J324- S24 PUSHOVER HOME TIMEOUT**

S24 Pushover home time out is the maximum time to wait for the Element transfer pushover assembly to reach home.

1. Do GP 6.4 to check S24 Pushover Home sensor.  
**This clears the fault**  
**Yes-** Return to normal operation  
**No-** Go to Step 2
2. Do GP 6.5 to check M12 Element Pushover Motor  
**This clears the fault**  
**Yes-** Return to normal operation  
**No-** Go to step 3
3. Inspect Pushover cams for signs of wear (PL 5.13)  
**Pushover cam shows signs of wear**  
**Yes-** Replace Element Pushover cams (REPs 3.16.5 and 3.16.6)  
**No-** Go to Step 4
4. Inspect Element Pushover springs, ensure they are installed properly (PL 5.13)  
**Element Pushover springs shows signs of wear**  
**Yes-** Replace Element pushover springs (REP 3.15.12)  
**No-** Go to Step 5
5. Inspect the Element Pushover for obstructions. Remove any debris or parts that may have fallen into the cavity.  
**Element Pushover is free of obstructions**  
**Yes-** Go to Step 6  
**No-** Clear the area and re-test
6. Do GP 6.3.5 FIRMWARE UPGRADE Procedure to Re-flash the firmware for eWire.  
**This clears the fault**  
**Yes-** Return to normal operation; **No-** Go to Step 6

7. Replace the Element transfer module (REP 3.15)

**This clears the fault**

**Yes-** Return to normal operation

**No-** Escalate to second level

8. Do REP 11.2 "B" Main Control Board Replacement.

**This clears the fault**

**Yes-** Return to normal operation;

**No-** Go to Step 7

#### **RTP 4.6 J325- S25 FEED BELT HOME TIMEOUT**

S25 Feed belt home time out is the maximum time to wait for the Element belt home sensor to detect the belt tooth.

1. Do GP 6.4 to check S25 Element belt home sensor

**This clears the fault**

**Yes-** Return to normal operation

**No-** Go to step 2

2. Do GP 6.5 to check M10 Element feed belt motor

**This clears the fault**

**Yes-** Return to normal operation

**No-** Go to step 3

3. Inspect the Element belt (PL 5.8). Check for missing teeth or any other damages

**Element belt is in good condition**

**Yes-** Go to Step 4

**No-** Replace the Element belt (REP 3.6)

4. Do ADJ 1.17 Element Feed Belt Tension Adjustment

**This clears the fault**

**Yes-** Return to normal operation;

**No-** Go to Step 5

5. Inspect Element feed belt idler for any damages or signs of wear (PL 5.9)

**Element feed belt idler is in good condition**

**Yes-** Go to Step 6

**No-** Replace Element feed belt idler (REP 3.11)

6. Inspect Element belt idlers (2x) (PL 5.9)

**Element belt idlers are in good condition**

**Yes-** Go to Step 7

**No-** Replace Element belt idler (REP 3.11)

7. Do GP 6.3.5 FIRMWARE UPGRADE Procedure to Re-flash the firmware for eWire.

**This clears the fault**

**Yes-** Return to normal operation;

**No-** Go to Step 8

8. Replace the Element feed belt (REP 3.6)

**This clears the fault**

**Yes-** Return to normal operation

**No-** Escalate to second level

9. Do REP 11.2 "B" Main Control Board Replacement.

**This clears the fault**

**Yes-** Return to normal operation;

**No-** Go to Step 7

### **RTP 4.7 J332- S32 EXPAND T HOME TIMEOUT**

S32 Expand T Home timeout is the maximum time to wait for the Expand T to reach its home position

1. Do GP 6.4 to check S32 Expanding T Home sensor

**This clears the fault**

**Yes-** Return to normal operation;

**No-** Go to Step 2

2. Do GP 6.5 to check M13 Expanding T motor

**This clears the fault**

**Yes-** Return to normal operation;

**No-** Go to step 3

3. Inspect the Expanding T cam assembly (PL 5.13). Check for the tightness of set screw in the motor shaft; signs of wear on the cam surface.

**Expanding T cam is secured tightly with the set screw, and the cam surface is in good condition**

**Yes-** Go to Step 4;

**No-** If the set screw is loose, tighten it. If the cam surface is worn, replace the cam assembly. Refer to REP 3.15.9

4. Inspect Expanding T springs (PL 5.13).

**Expanding T springs are in good condition**

**Yes-** Go to Step 5;

**No-** Replace Expanding T springs (REP 3.15.10)

5. Inspect Expanding T arms (PL 5.13).

**Expanding T arms are straight and in good condition**

**Yes-** Go to Step 6;

**No-** Replace Expanding T arms (REP 3.15.13)



6. Inspect Element transfer racks (PL 5.13)  
**Element transfer racks are in good condition**  
**Yes-** Go to Step 7;  
**No-** Replace Element transfer racks (REP 3.15.4)
7. Inspect Element transfer gears (PL 5.13)  
**Element transfer gears are in good condition**  
**Yes-** Go to Step 8;  
**No-** Replace Element transfer gears (REP 3.15.4)
8. Do GP 6.3.5 FIRMWARE UPGRADE Procedure to Re-flash the firmware for eWire.  
**This clears the fault**  
**Yes-** Return to normal operation;  
**No-** Go to Step 9
9. Replace the Element transfer module (REP 3.15)  
**This clears the fault**  
**Yes-** Return to normal operation;  
**No-** Go to Step 10
10. Do REP 11.2 "B" Main Control Board Replacement.  
**This clears the fault**  
**Yes-** Return to normal operation;  
**No-** Escalate to second level

#### **RTP 4.8 J333- S33 EXPAND T OUT TIMEOUT**

S33 Expand T Out timeout is the maximum time to wait for the Expand T to reach its home position

1. Do GP 6.4 to check S33 Expanding T Out sensor  
**This clears the fault**  
**Yes-** Return to normal operation;  
**No-** Go to Step 2
2. Do GP 6.5 to check M13 Expanding T motor  
**This clears the fault**  
**Yes-** Return to normal operation;  
**No-** Go to step 3
3. Inspect the Expanding T cam assembly (PL 5.13). Check for the tightness of set screw in the motor shaft; signs of wear on the cam surface.  
**Expanding T cam is secured tightly with the set screw, and the cam surface is in good condition**  
**Yes-** Go to Step 4;  
**No-** If the set screw is loose, tighten it. If the cam surface is worn, replace the cam assembly. Refer to REP 3.15.9
4. Inspect Expanding T arms (PL 5.13).  
**Expanding T arms are straight and in good condition**  
**Yes-** Go to Step 5;  
**No-** Replace Expanding T arms (REP 3.15.12)
5. Inspect Expanding T springs (PL 5.13).  
**Expanding T springs are in good condition**  
**Yes-** Go to Step 6;  
**No-** Replace Expanding T springs (REP 3.15.12)

6. Inspect Element transfer racks for obstructions. Inspect the Expanding T Mechanism for loose parts or obstructions. (PL 5.13)  
**Element transfer mechanism is clear and in good condition**  
**Yes-** Go to Step 7;  
**No-** Replace Element transfer racks (REP 3.15.4)
7. Inspect Element transfer gears (PL 5.13)  
**Element transfer racks are in good condition**  
**Yes-** Go to Step 8;  
**No-** Replace Element transfer gears (REP 3.15.4)
8. Do GP 6.3.5 FIRMWARE UPGRADE Procedure to Re-flash the firmware for eWire.  
**This clears the fault**  
**Yes-** Return to normal operation;  
**No-** Go to Step 9
9. Replace M13 Expanding T motor even if it is functioning properly after being manually engaged in service settings  
**This clears the fault**  
**Yes-** Return to normal operation;  
**No-** Go to Step 10
10. Replace the Element transfer module (REP 3.15)  
**This clears the fault**  
**Yes-** Return to normal operation;  
**No-** Go to Step 11
11. Do REP 11.2 "B" Main Control Board Replacement.  
**This clears the fault**  
**Yes-** Return to normal operation;  
**No-** Escalate to second level

#### **RTP 4.9 J334- FEED BELT JAM**

Feed belt jam is reported when the Element home sensor does not change state within the allowed time.

1. Check if the element spool is loaded properly.  
**Element spool is loaded properly**  
**Yes-** Go to Step 2;  
**No-** Remove the element spool and reinsert it properly
2. Inspect the Element belt (PL 5.8). Check for missing teeth or any other damages  
**Element belt is in good condition**  
**Yes-** Go to Step 3;  
**No-** Replace the Element belt (REP 3.6)
3. Do GP 6.4 to check S25 Element belt home sensor  
**This clears the fault**  
**Yes-** Return to normal operation;  
**No-** Go to step 4
4. Do ADJ 1.17 Element Feed Belt Tension Adjustment  
**This clears the fault**  
**Yes-** Return to normal operation;  
**No-** Go to Step 5
5. Inspect Element feed belt idler for any damages or signs of wear (PL 5.8)  
**Element feed belt idler is in good condition**  
**Yes-** Go to Step 6;  
**No-** Replace Element feed belt idler (REP 3.11)
6. Inspect Element belt idlers (2x) (PL 5.9)  
**Element belt idlers are in good condition**  
**Yes-** Go to Step 7;  
**No-** Replace Element belt idler (REP 3.11)

7. Do GP 6.5 to check M10 Element feed belt motor  
**This clears the fault**  
**Yes-** Return to normal operation;  
**No-** Go to step 8
  
8. Do GP 6.3.5 FIRMWARE UPGRADE Procedure to Re-flash the firmware for eWire.  
**This clears the fault**  
**Yes-** Return to normal operation;  
**No-** Go to Step 9
  
9. Replace the Element feed belt (REP 3.6)  
**This clears the fault**  
**Yes-** Return to normal operation;  
**No-** Go to Step 10
  
10. Do REP 11.2 "B" Main Control Board Replacement.  
**This clears the fault**  
**Yes-** Return to normal operation;  
**No-** Escalate to second level

#### **RTP 4.10 J350- SPOOL NEAR EMPTY**

J350 is displayed when the Element spool does not have sufficient elements to make books. Follow this procedure if the machine erroneously displays this message with an element spool with at least one full row of elements

1. Check if the element spool is loaded properly, and if it contains at least one row of elements. Try loading a fresh spool and repeat the process.  
**Element spool is loaded properly, it contains at least one row of elements. The problem exists with more than one spool**  
**Yes-** Go to Step 2;  
**No-** Refer to GP 6.7 to properly install the spool.
  
2. Do GP 6.4 to check S50 Spool Near Empty sensor  
**This clears the fault**  
**Yes-** Return to normal operation;  
**No-** Go to step 3
  
3. Inspect spool spindle sub-assembly, replace if necessary  
**Spool spindle sub-assembly is in good condition**  
**Yes-** Go to Step 4;  
**No-** Replace Spool spindle sub-assembly.
  
4. Do GP 6.3.5 FIRMWARE UPGRADE Procedure to Re-flash the firmware for eWire.  
**This clears the fault**  
**Yes-** Return to normal operation;  
**No-** Go to Step 5
  
5. Do REP 11.2 "B" Main Control Board Replacement.  
**This clears the fault**  
**Yes-** Return to normal operation;  
**No-** Escalate to second level

#### RTP 4.11 J351- S32 & S33 BOTH BLOCKED

J351 will occur when the S32 and S33 sensors are both blocked at the same time. S32 and S33 sensors are both used on the Pushover mechanism.

1. Open the Element Feeder drawer. Inspect the pushover mechanism area for any debris or obstruction. Inspect the 4 Cams for damage. Remove any foreign object that may be obstructing the area.

**This clears the fault**

**Yes-** Return to normal operation;

**No-** Go to step 2

2. Do GP 6.4.3 to check the S32 and S33 sensors.

**This clears the fault**

**Yes-** Return to normal operation;

**No-** Go to step 3

3. Do GP 6.5.7 to check the function of Motor 12 and Motor 13.

**This clears the fault**

**Yes-** Return to normal operation;

**No-** Go to step 4

4. Do REP 3.15 to remove the Expanding T mechanism from the eWire. Thoroughly inspect and ensure no foreign objects are stuck in the Expanding T. Replace the module and repeat steps 2 and 3.

**This clears the fault**

**Yes-** Return to normal operation;

**No-** Escalate to second level.

#### RTP 4.12 J361- RESIDUAL ELEMENT ERROR

J361 is displayed when there is a residual element on the Element Feed Belt somewhere between S21 Element detect at Knife and S22 Element detect at Pyramid. Follow this procedure when this message is displayed erroneously (i.e. when there is no element present on the belt) or if this jam occurs very frequently during operation.

1. Check the Element Feed Belt area for dust and debris. Use compressed air to clean the areas around S21 and S22. Do GP 6.15.5 to clean the film between the S22 sensor emitter and receiver.

**This clears the fault**

**Yes-** Return to normal operation;

**No-** Go to Step 2

2. Do GP 6.4 to check the S21, S22 & S25 sensors.

**This clears the fault**

**Yes-** Return to normal operation;

**No-** Go to Step 3

3. Check that all Interlocks are being properly engaged. An improperly set flag or defective interlock may cut power to the machine unexpectedly during a feed element operation.

**A message CLOSE DOOR, CLOSE TRAY, or CLOSE COVER displays briefly during operation before showing J361**

**Yes-** Do ADJ 1.7 to adjust the Interlock Flags;

**No-** Go to Step 4

4. Inspect the Element Feed Belt for damage. Observe each tooth to ensure there are no large cracks or gouges.

**Element Feed Belt is damaged**

**Yes-** Do REP 3.6 to replace the Element Feed Belt;

**No-** Go to Step 5

5. Do ADJ 1.17 to check the Element Feed Belt tension.

**Element Feed Belt is properly tensioned.**

**Yes-** Escalate to second level;

**No-** Do ADJ 1.17 to correct the Element Feed Belt tension.

### **RTP 4.13 J362- ELEMENT FAILED TO CUT**

J362 is displayed when the S21 Element detect at Knife sensor does not detect that the wire has been cut.

1. Inspect the spool and check that the spool slack is correct. If the slack is not correct, reinstall the spool GP 6.7

**This clears the fault**

**Yes-** Return to normal operation;

**No-** Go to Step 2

2. Do GP 6.4 to check S21 Element Detect at Knife sensor

**This clears the fault**

**Yes-** Return to normal operation;

**No-** Go to Step 3

3. Do GP 6.5.6 to check the Knife function.

**This clears the fault**

**Yes-** Return to normal operation;

**No-** Go to step 4

4. Do GP 6.3.5 and run the Feed Element functional test. Determine if the Knife actually cuts the Element. The cut should be clean, with no excess material remaining after cutting.

**Does the Knife cut the Element cleanly?**

**Yes-** Go to Step 5;

**No-** Go to step 7

5. When doing the Feed Element test, determine if there is a gap between the cut section of wire and the remaining wire. If the wire is "bunched up," this can cause erroneous J362 errors.

**Is there a visible gap between the cut wire and remaining wire immediately after cut?**

**Yes-** Go to Step 7;

**No-** Go to Step 6

6. Adjust the Feed Belt Home Position. Refer to ADJ 1.4 for additional detail. Adjust the Feed Belt Home in increments of -1 and repeat Step 2. The Belt tooth should mesh easily with the wire, and a small gap should be observed immediately after the wire is cut by the Knife.

**This clears the fault**

**Yes-** Return to normal operation;

**No-** Go to Step 6

7. Check to see if the knife is parallel with the anvil.

**Yes-** go to step 8

**No-** Perform ADJ 1.18 Knife Blade Adjustment.

8. Do REP 3.14.3 to replace the Knife Blade.

**This clears the fault**

**Yes-** Return to normal operation;

**No-** Go to Step 9

9. Do REP 3.14 to replace the Knife Module.

**This clears the fault**

**Yes-** Return to normal operation;

**No-** Escalate to second level

#### **RTP 4.14 J363- FEED BELT HOME STEPS TIMEOUT**

J363 is triggered when it takes longer than the specified time for the Element belt to feed the element. This can be caused due to a jammed Element along the Element belt path

1. Ensure there are no obstructions or residual fragment of the element on the belt.

**The Element belt is free of obstructions**

**Yes-** Go to Step 2

**No-** Remove the obstructions and ensure smooth travel of the belt.

2. Manually rotate the Element belt and ensure smooth operation

**The Element belt moves smoothly without any binding**

**Yes-** Go to Step 4.

**No-** Go to Step 3

3. Inspect closely to determine where the binding occurs. Binding is most likely to occur on the Element engagement guide, or the Track assembly (PL 5.9).

**Belt operates smoothly**

**Yes-** Go to Step 4

**No-** Replace affected parts (PL 5.9)

4. Check if the element spool is loaded properly.

**Element spool is loaded properly**

**Yes-** Go to Step 5

**No-** Remove the element spool and reinsert it properly

5. Inspect the Element belt (PL 5.8.) Check for missing teeth or any other damages

**Element belt is in good condition**

**Yes-** Go to Step 6

**No-** Replace the Element belt (REP 3.6)

6. Do GP 6.4 to check S25 Element belt home sensor

**This clears the fault**

**Yes-** Return to normal operation;

**No-** Go to step 7

7. Do ADJ 1.17 Element Feed Belt Tension Adjustment

**This clears the fault**

**Yes-** Return to normal operation;

**No-** Go to Step 8

8. Inspect Element feed belt idler for any damages or signs of wear (PL 5.9)

**Element feed belt idler is in good condition**

**Yes-** Go to Step 9;

**No-** Replace Element feed belt idler (REP 3.11)

9. Inspect Element belt idlers (2x) (PL 5.9)

**Element belt idlers are in good condition**

**Yes-** Go to Step 10;

**No-** Replace Element belt idler (REP 3.11)

10. Do GP 6.5 to check M10 Element feed belt motor

**This clears the fault**

**Yes-** Return to normal operation;

**No-** Go to step 11

11. Do GP 6.3.5 FIRMWARE UPGRADE Procedure to Re-flash the firmware for eWire.

**This clears the fault**

**Yes-** Return to normal operation;

**No-** Go to Step 12

12. Replace the Element feed belt (REP 3.6)

**This clears the fault**

**Yes-** Return to normal operation;

**No-** Go to Step 13

13. Do REP 11.2 "B" Main Control Board Replacement.

**This clears the fault**

**Yes-** Return to normal operation;

**No-** Escalate to second level

#### **RTP 4.15 J364- M9 ELEMENT BACKUP STEPS TIMEOUT**

J364 is triggered when it takes longer than specified time for M9 Element sprocket motor to back up the element.

1. Ensure that the element is not tangled on the sprocket of the feed section.

**The Element is not tangled on the sprocket**

**Yes-** Go to Step 2

**No-** Remove the damaged element and reinstall the spool.

2. Check if the element spool is loaded properly.

**Element spool is loaded properly**

**Yes-** Go to Step 3

**No-** Remove the element spool and reinsert it properly

3. Manually rotate the Element sprocket and ensure smooth operation.

**Element tip does not catch corners when moved using the sprocket**

**Yes-** Go to Step 4

**No-** If the edge of an element catches a corner, trim the edge.  
Resume normal operation

4. Ensure there are no obstructions or residual fragment of the element on the belt.

**The Element belt is free of obstructions**

**Yes-** Go to Step 5

**No-** Remove the obstructions and ensure smooth travel of the belt.

5. Manually rotate the Element belt and ensure smooth operation

**The Element belt moves smoothly without any binding**

**Yes-** Go to Step 6.

**No-** Go to Step 7

6. Do GP 6.5 to check M9 Element feed sprocket motor  
**This clears the fault**  
**Yes-** Return to normal operation;  
**No-** Go to step 5
  
7. Inspect the Element sprocket nose sub-assembly for any damage.  
**Element sprocket nose sub-assembly is damaged.**  
**Yes-** Replace the Sprocket Nose sub-assembly (REP 3.13);  
**No-** Go to Step 6
  
8. Do GP 6.5.5 Check M9 and M10  
**This clears the fault**  
**Yes-** Return to normal operation;  
**No-** Go to Step 9
  
9. Do GP 6.3.5 FIRMWARE UPGRADE Procedure to Re-flash the firmware for eWire.  
**This clears the fault**  
**Yes-** Return to normal operation;  
**No-** Go to Step 10
  
10. Do REP 11.2 "B" Main Control Board Replacement.  
**This clears the fault**  
**Yes-** Return to normal operation;  
**No-** Escalate to level two

#### **RTP 4.16 J365- M9 MESH STEPS TIMEOUT**

J365 is triggered when it takes longer than the specified time for the lead edge of the element to mesh with the Element belt.

1. Ensure that the element is not tangled on the sprocket of the feed section.  
**The Element is not tangled on the sprocket**  
**Yes-** Go to Step 2  
**No-** Untangle the element and resume normal operation
  
2. Manually rotate the Element sprocket and ensure smooth operation.  
**Element tip does not catch corners when moved using the sprocket**  
**Yes-** Go to Step 3  
**No-** If the edge of an element catches a corner, trim the edge. Resume normal operation
  
3. Check if the element spool is loaded properly.  
**Element spool is loaded properly**  
**Yes-** Go to Step 4  
**No-** Remove the element spool and reinsert it properly
  
4. Do GP 6.5 to check M9 Element feed sprocket motor  
**This clears the fault**  
**Yes-** Return to normal operation  
**No-** Go to step 5
  
5. Inspect the Element sprocket nose sub-assembly for any damage.  
**Element sprocket nose sub-assembly is damaged**  
**Yes-** Replace the Sprocket Nose sub-assembly (REP 3.13)  
**No-** Go to Step 6
  
6. Do ADJ 1.4 Element Feed Belt Home Position.  
**This clears the fault**  
**Yes-** Return to normal operation  
**No-** Go to Step 7



7. Do 6.3.5 FIRMWARE UPGRADE Procedure to Re-flash the firmware for eWire.

**This clears the fault**

**Yes-** Return to normal operation;      **No-** Go to Step 8

8. Do REP 11.2 “B” Main Control Board Replacement.

**This clears the fault**

**Yes-** Return to normal operation;      **No-** Escalate to level two

#### **RTP 4.17 J366- ELEMENT AT PUSHOVER STEPS TIMEOUT**

J366 is triggered if it takes longer than specified time for motor M10 to complete the necessary number of steps from the S22 Element Detect at Pyramid to the position for Pushover.

Follow the procedure in **RTP 4.12**

#### **RTP 4.18 J367- ELEMENT STEPS TIMEOUT**

J367 is triggered if it takes longer than specified time for motor M9 to run the number of steps to feed the correct length of element based on the sheet size of books.

Follow the procedure in **RTP 4.14**

#### **RTP 4.19 J368- PUSHOVER FWD ENCODER TIMEOUT**

J368 is triggered if it takes longer than specified time to count the encoder steps needed for the Pushover to go in the forward direction.

1. Do GP 6.4 to check S31 Pushover encoder sensor

**This clears the fault**

**Yes-** Return to normal operation;

**No-** Go to Step 2

2. Do GP 6.5 to check M12 Element pushover motor

**This clears the fault**

**Yes-** Return to normal operation;

**No-** Go to Step 3

3. Replace the Pushover Motor Assembly (PL 5.13)

**This clears the fault**

**Yes-** Return to normal operation;

**No-** Go to Step 4



4. Do 6.3.5 FIRMWARE UPGRADE Procedure to Re-flash the firmware for eWire.

**This clears the fault**

**Yes-** Return to normal operation;

**No-** Go to Step 5

5. Do REP 11.2 "B" Main Control Board Replacement.

**This clears the fault**

**Yes-** Return to normal operation;

**No-** Escalate to second level

## 5 BIND JAM CODES

### RTP 5.1 J370- HOLDER AT S37 TIMEOUT

J370 is triggered if it takes longer than specified time for the Holder to reach S37. The holder then moves forward a set number of motor steps for Stacking position

1. J370 may be triggered by an oversized book preventing the holder from moving. Confirm that the book capacity being run does not exceed what is listed in the Book Quality Section of this manual.

#### **Book was oversized**

**Yes-** Return to normal operation;

**No-** Go to Step 2

2. Do GP 6.4 to check S37 Holder Stack position sensor

#### **This clears the fault**

**Yes-** Return to normal operation;

**No-** Go to Step 3

3. Check the Condition of the Holder linear drive belt- Front and Rear (PL 5.21)

#### **The timing belt is in good condition. There are no missing teeth and the belt is not frayed**

**Yes-** Go to Step 4

**No-** Replace the damaged timing belt (REP 8.11, 8.12) and resume operation

4. Check the tension of the Holder linear drive belt tension- Front and Rear (ADJ 1.6)

#### **The tension of the timing belts is good**

**Yes-** Go to Step 5

**No-** Do to ADJ 1.6 to set the belt tension and resume operation

5. Visually check if the rollers of the Holder are centered in the cam tracks.

#### **The rollers are centered in the cam tracks**

**Yes-** Go to Step 6

**No-** Loosen the cam track assembly and bring the roller inside the cam track. Resume operation

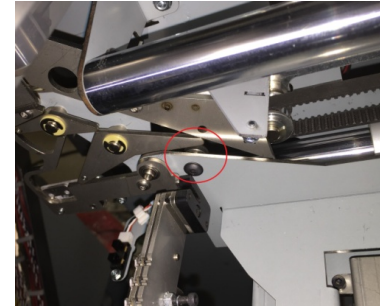

6. Check if the set screws on all the six pulleys associated with the Holder linear drive are tight

#### **The set screws are tight**

**Yes-** Go to Step 7

**No-** Tighten the loose set screw(s) and resume operation

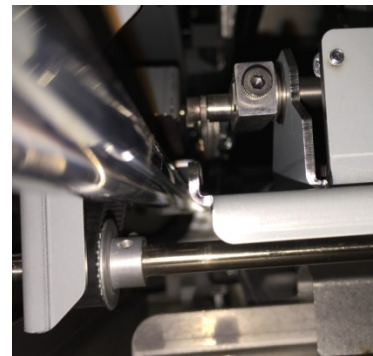
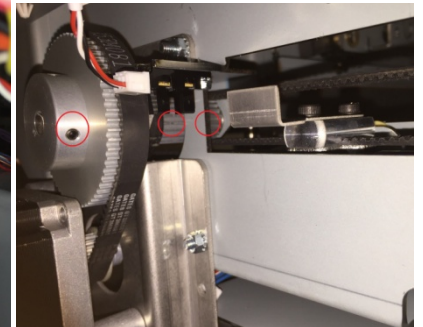
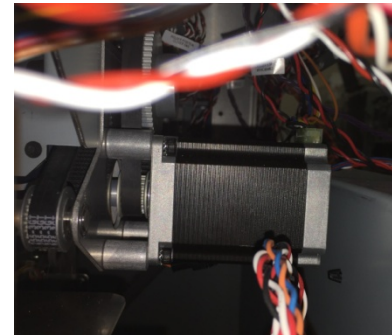

7. Manually move the Holder linear mechanism and watch if the sheet metal feature blocks/unblocks S37 Holder Stack position sensor.

**The sensor is blocked/unblocked properly**

**Yes-** Go to Step 8

**No-** Escalate to second level

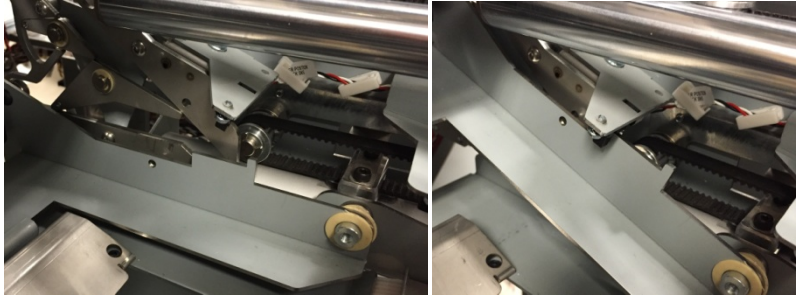

8. Do GP 6.5 to check M15 Holder linear drive motor

**This clears the fault**

**Yes-** Return to normal operation;

**No-** Go to step 9;

9. Inspect the springs for the Holder gates (PL 5.21).

**Holder gates springs are present and not damaged**

**Yes-** Go to Step 10;

**No-** Replace the missing/damaged spring

10. Do GP 6.3.5 FIRMWARE UPGRADE Procedure to Re-flash the firmware for eWire.

**This clears the fault**

**Yes-** Return to normal operation;

**No-** Go to Step 11

11. Do REP 11.2 "B" Main Control Board Replacement.

**This clears the fault**

**Yes-** Resume operation;

**No-** Escalate to second level

## **RTP 5.2 J371- S38 HOLDER POSITION ELEMENT TIMEOUT**

J371 is triggered if it takes longer than specified time for the Holder to reach S38 Holder at Element position sensor

1. Do GP 6.4 to check S38 Holder Element position sensor

**This clears the fault**

**Yes-** Return to normal operation;

**No-** Go to Step 2

2. Check the Condition of the Holder linear drive belt- Front and Rear (PL 5.21)

**The timing belt is in good condition. There are no missing teeth and the belt is not frayed**

**Yes-** Go to Step 3;

**No-** Replace the damaged timing belt (REP 8.11, 8.12) and resume operation

3. Check the tension of the Holder linear drive belt tension- Front and Rear (ADJ 1.6)

**The tension of the timing belts is good**

**Yes-** Go to Step 4;

**No-** Do to ADJ 1.6 to set the belt tension and resume operation

4. Visually check if the rollers of the Holder are centered in the cam tracks.

**The rollers are centered in the cam tracks**

**Yes-** Go to Step 5;

**No-** Loosen the cam track assembly and bring the roller inside the cam track. Resume operation

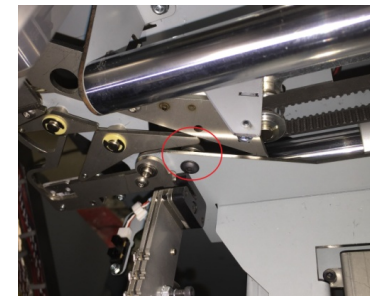

5. Check if the set screws on all the six pulleys associated with the Holder linear drive are tight

**The set screws are tight**

**Yes-** Go to Step 6;

**No-** Tighten the loose set screw(s) and resume operation

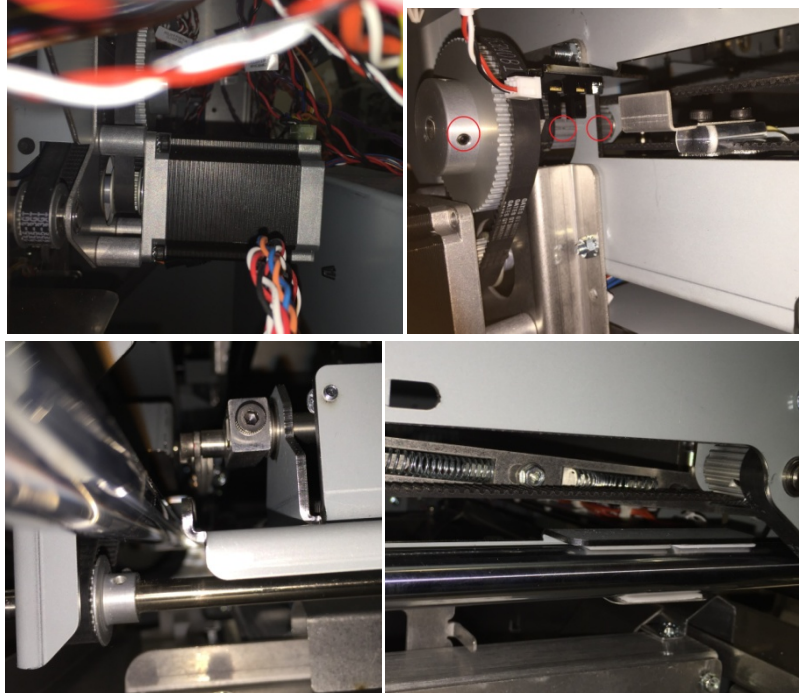

6. Manually move the Holder linear mechanism and watch if the sheet metal feature blocks/unblocks S38 Holder Stack position sensor.

**The sensor is blocked/unblocked properly**

**Yes-** Go to Step 7;

**No-** Escalate to second level

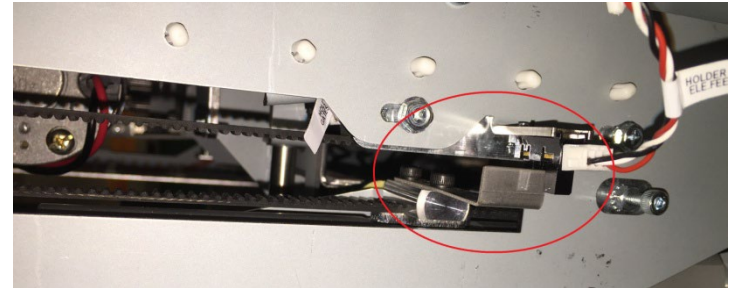

7. Do GP 6.5 to check M15 Holder linear drive motor

**This clears the fault**

**Yes-** Return to normal operation;

**No-** Go to step 8

8. Inspect the springs for the Holder gates (PL 5.21).

**Holder gates springs are present and not damaged**

**Yes-** Go to Step 9;

**No-** Replace the missing/damaged spring

9. Do GP 6.3.5 FIRMWARE UPGRADE Procedure to Re-flash the firmware for eWire.

**This clears the fault**

**Yes-** Return to normal operation;

**No-** Go to Step 10

10. Do REP 11.2 "B" Main Control Board Replacement.

**This clears the fault**

**Yes-** Resume operation;

**No-** Escalate to second level

### RTP 5.3 J372- S39 DETECT AT REV GATE TIMEOUT

J372 is triggered if it takes longer than specified time for the Holder to reach S39 Holder at Reverse Gate sensor

1. Do GP 6.4 to check S39 Holder at Reverse gate sensor

**This clears the fault**

**Yes-** Return to normal operation;

**No-** Go to Step 2

2. Check the Condition of the Holder linear drive belt- Front and Rear (PL 5.21)

**The timing belt is in good condition. There are no missing teeth and the belt is not frayed**

**Yes-** Go to Step 3;

**No-** Replace the damaged timing belt (REP 8.11, 8.12) and resume operation

3. Check the tension of the Holder linear drive belt tension- Front and Rear (ADJ 1.6)

**The tension of the timing belts is good**

**Yes-** Go to Step 4;

**No-** Do to ADJ 1.6 to set the belt tension and resume operation

4. Visually check if the rollers of the Holder are centered in the cam tracks.

**The rollers are centered in the cam tracks**

**Yes-** Go to Step 5;

**No-** Loosen the cam track assembly and bring the roller inside the cam track. Resume operation

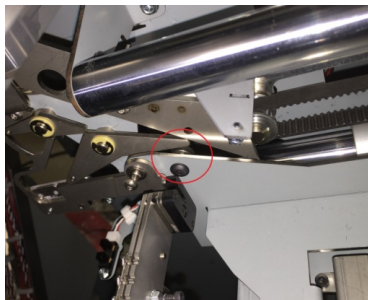

5. Check if the set screws on all the six pulleys associated with the Holder linear drive are tight

**The set screws are tight**

**Yes-** Go to Step 6;

**No-** Tighten the loose set screw(s) and resume operation

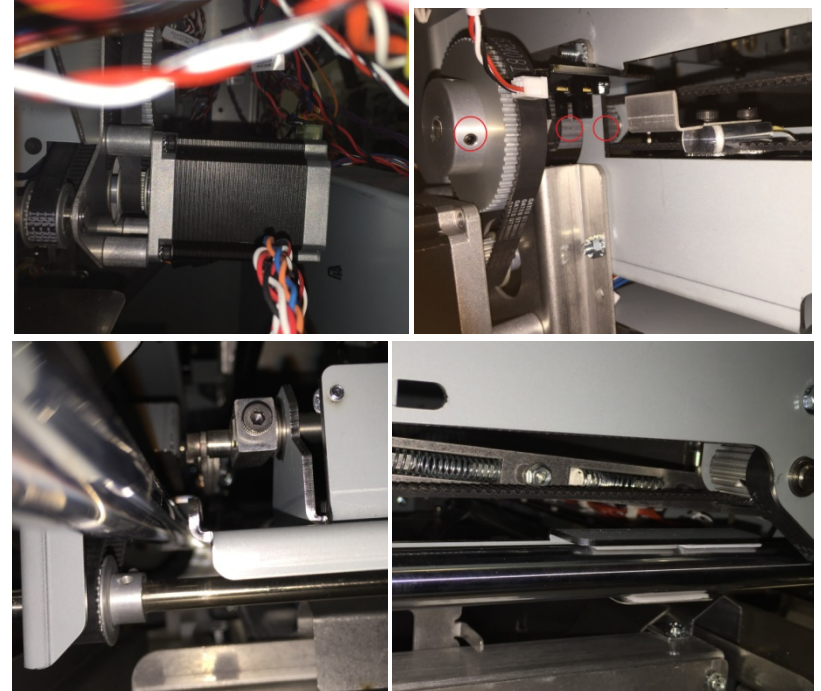

6. Manually move the Holder linear mechanism and watch if the sheet metal feature blocks/unblocks S39 Holder at Reverse Gates sensor.

**The sensor is blocked/unblocked properly**

**Yes-** Go to Step 7;

**No-** Escalate to second level

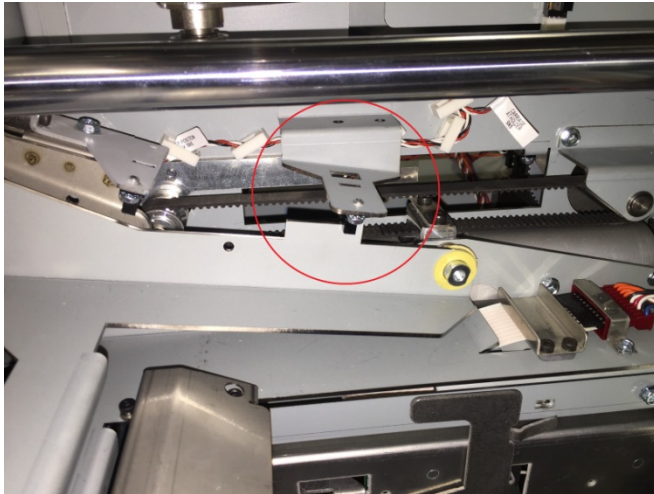

7. Do GP 6.5 to check M15 Holder linear drive motor

**This clears the fault**

**Yes-** Return to normal operation;

**No-** Go to step 8

8. Inspect the springs for the Holder gates (PL 5.21).

**Holder gates springs are present and not damaged**

**Yes-** Go to Step 9;

**No-** Replace the missing/damaged spring

9. Go to RTP 5.20, Step 5 and 6 to ensure the Holder rotate components are in good order.

**Holder rotate components are in good order**

**Yes-** Go to Step 10;

**No-** Follow steps in RTP 5.20 to take the necessary corrective action

10. Do GP 6.3.5 FIRMWARE UPGRADE Procedure to Re-flash the firmware for eWire.

**This clears the fault**

**Yes-** Return to normal operation;

**No-** Go to Step 11

11. Do REP 11.2 "B" Main Control Board Replacement.

**This clears the fault**

**Yes-** Return to normal operation;

**No-** Escalate to second level

#### RTP 5.4 J373- S40 AT BOOK DROP POSITION TIMEOUT

J373 is triggered when it takes longer than the specified time for the Holder to reach S40 Holder at Element Feeder Sensor from the Book Drop position.

1. Do GP 6.4 to check S40 Holder at Element Feeder sensor

**This clears the fault**

**Yes-** Return to normal operation;

**No-** Go to Step 2

2. Check the Condition of the Holder linear drive belt- Front and Rear (PL 5.21)

**The timing belt is in good condition. There are no missing teeth and the belt is not frayed**

**Yes-** Go to Step 3;

**No-** Replace the damaged timing belt (REP 8.11, 8.12) and resume operation

3. Check the tension of the Holder linear drive belt tension- Front and Rear (ADJ 1.6)

**The tension of the timing belts is good**

**Yes-** Go to Step 4;

**No-** Do ADJ 1.6 to set the belt tension and resume operation

4. Visually check if the rollers of the Holder are centered in the cam tracks.

**The rollers are centered in the cam tracks**

**Yes-** Go to Step 5;

**No-** Loosen the cam track assembly and bring the roller inside the cam track. Resume operation

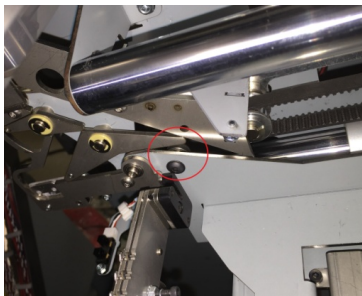

5. Check if the set screws on all the six pulleys associated with the Holder linear drive are tight

**The set screws are tight**

**Yes-** Go to Step 6;

**No-** Tighten the loose set screw(s) and resume operation

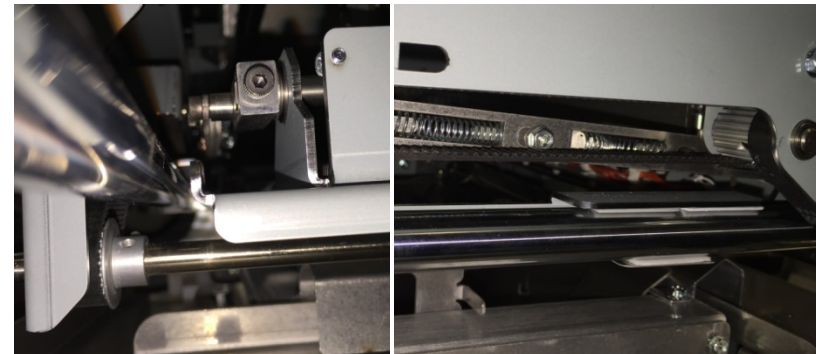
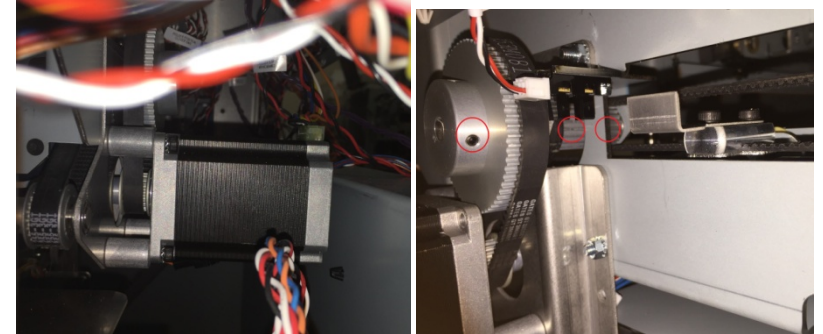

6. Manually move the Holder linear mechanism and watch if the sheet metal feature blocks/unblocks S40 Holder at Element feeder sensor.

**The sensor is blocked/unblocked properly**

**Yes-** Go to Step 7;

**No-** Escalate to second level

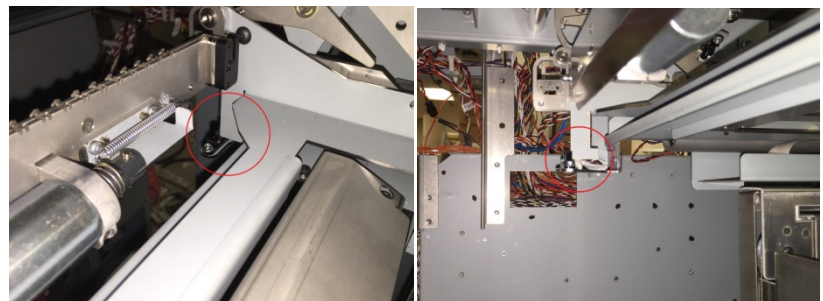



7. Do GP 6.5 to check M15 Holder linear drive motor  
**This clears the fault**  
**Yes-** Return to normal operation;  
**No-** Go to step 8
  
8. Inspect the springs for the Holder gates (PL 5.21).  
**Holder gates springs are present and not damaged**  
**Yes-** Go to Step 9;  
**No-** Replace the missing/damaged spring
  
9. Go to RTP 5.20, Step 5 and 6 to ensure the Holder rotate components are in good order.  
**Holder rotate components are in good order**  
**Yes-** Go to Step 10;  
**No-** Follow steps in RTP 5.20 to take the necessary corrective action
  
10. Do GP 6.3.5 FIRMWARE UPGRADE Procedure to Re-flash the firmware for eWire.  
**This clears the fault**  
**Yes-** Return to normal operation;  
**No-** Go to Step 11
  
11. Do REP 11.2 "B" Main Control Board Replacement.  
**This clears the fault**  
**Yes-** Return to normal operation;  
**No-** Escalate to second level

### RTP 5.5 J374- S46 BOOK DROP TIMEOUT

J374 is triggered when it takes longer than the specified time for the Closer to reach S46 Closer Home after the book is ejected.

1. Do GP 6.4 to check S46 Closer Home Sensor.  
**This clears the fault**  
**Yes-** Return to normal operation;  
**No-** Go to Step 2
  
2. Check the Condition of the Closer Linear Drive Belt (PL 5.21).  
**The timing belt is in good condition. There are no missing teeth and the belt is not frayed**  
**Yes-** Go to Step 3;  
**No-** Replace the damaged timing belt (REP 8.10) and resume operation
  
3. Check the tension of the Closer Linear Drive Belt (ADJ 1.6).  
**The tension of the timing belt is good**  
**Yes-** Go to Step 4;  
**No-** Do to ADJ 1.6 to set the belt tension and resume operation
  
4. Check if the set screw on the Closer motor pulley and the screws in the drive components are sufficiently tight.  
**The screws are tight**  
**Yes-** Go to Step 5;  
**No-** Tighten the loose set screw(s) and resume operation

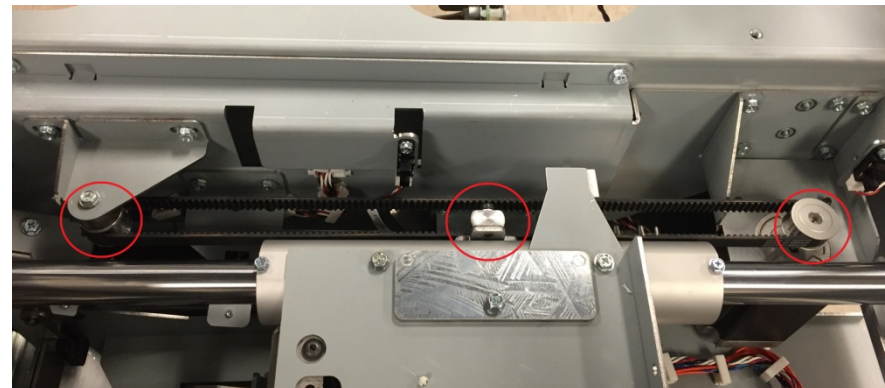

5. Manually move the Closer linear mechanism and watch if the sheet metal feature blocks/unblocks S46 Closer Home sensor.

**The sensor is blocked/unblocked properly**

**Yes-** Go to Step 6;

**No-** Escalate to second level



6. Do GP 6.5 to check M21 Closer Linear Drive Motor.

**This clears the fault**

**Yes-** Return to normal operation;

**No-** Go to step 7

7. Inspect the Closer drive mechanism on the Front side of the machine for any loose objects preventing smooth operation. Check if there is any debris like paper scraps, loose elements, etc. in this area that may be restricting motion.

**The drive system is free of obstructions**

**Yes-** Go to Step 8;

**No-** Clear the obstruction

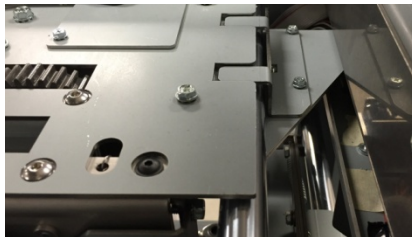

8. Do GP 6.3.5 FIRMWARE UPGRADE Procedure to Re-flash the firmware for eWire.

**This clears the fault**

**Yes-** Return to normal operation;

**No-** Go to Step 9

9. Do REP 11.2 "B" Main Control Board Replacement.

**This clears the fault**

**Yes-** Return to normal operation;

**No-** Escalate to second level

### RTP 5.6 J375- BOOK DROP POSITION TIMEOUT

J375 is triggered when it takes longer than the specified time for the Closer to move to the Book Drop position from the Closer at Holder position.

1. Do GP 6.4 to check S49 Closer Staged Sensor

**This clears the fault**

**Yes-** Return to normal operation;

**No-** Go to Step 2

2. Manually move the Closer linear mechanism and watch if the sheet metal feature blocks/unblocks S49 Closer Staged sensor.

**The sensor is blocked/unblocked properly**

**Yes-** Go to Step 3;

**No-** Escalate to second level



3. Do the steps in RTP 5.5 [J374- S46 BOOK DROP TIMEOUT](#)

### RTP 5.7 J376- CLOSER AT HOLDER STEPS TIMEOUT

J376 is triggered when it takes longer than the specified time for the Closer to move to the Closer at Holder position from its staged position.

Do the steps in RTP 5.6 [J375- BOOK DROP POSITION TIMEOUT](#)

### RTP 5.8 J377- CLOSER CARRIAGE HOME TIMEOUT

J377 is triggered when it takes longer than the specified time for the Closer to reach S46 Closer Home after the bound book is ejected from the closer.

Do the steps in RTP 5.5 [J374- S46 BOOK DROP TIMEOUT](#)

### RTP 5.9 J379- CLOSER JAWS HOME ENCODER TIMEOUT

J379 occurs when the Closer Encoder Home is not reached after a second attempt. J379 occurs when both attempts to reach home are not successful.

Do the steps in RTP 5.26 [J396- CLOSER RE-HOME ENCODER TIMEOUT](#)

### RTP 5.10 J380- CLOSER JAWS HOME TIMEOUT

J380 is triggered if it takes longer than the specified time for the Upper Jaw to move to its home position and change the state of S47 Closer Full Open.

1. This may be caused by the closer cams being out of phase. A symptom of this would be an increasing level of elements being closed unevenly. To check this, remove the Front Closer Cover and the Top Closer Cover by removing the M4 screws (3)

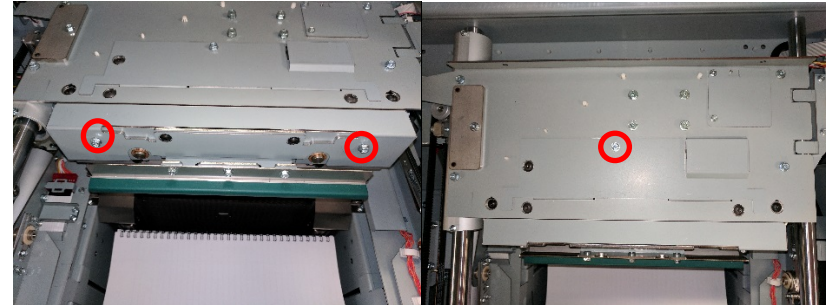

With this cover removed and the cams visible, perform GP 6.3.3 to active M20. Watch the cams rotate.

**Are the cams rotating in phase?**

**Yes** – Go to step 2;

**No** – Perform ADJ 1.11 Closer Cam Phase Adjustment.

2. Remove the M3 Screws (2) holding the Cable Access Cover. Check that the Flat Mylar Closer Cable is plugged in and properly seated in its housing as shown.

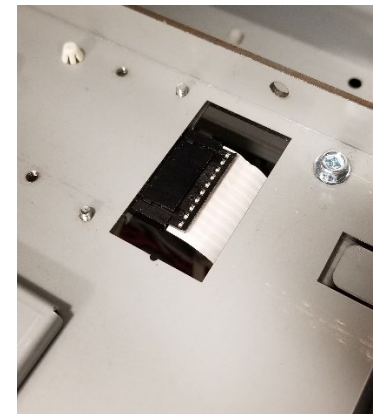

**Cable is plugged in and properly seated**

**Yes-** Go to Step 3;

**No-** Plug in the cable close all covers and cycle the Element Feeder Door interlock.

**This clears the fault**

**Yes-** Reinstall the Cable Cover and return to normal operation;

**No-** Go to Step 2.

3. Check the area exposed in step 1 for debris i.e. screws, elements, or other foreign objects

**Closer cam and chain areas are free of foreign objects.**

**Yes-** Go to Step 4.

**No-** Remove the object(s). If the debris is unable to be removed, do REP 6.4 to remove the M20 Closer Motor. Rotate the large drive gear by hand to rotate the cams and chain and release any objects. If the debris is still unable to be removed, escalate to second level.

**This clears the fault**

**Yes-** Reinstall the covers and return to normal operation;

**No-** Go to Step 4.

4. Do GP 6.5 to check M20 Closer Motor.

**This clears the fault**

**Yes-** Return to normal operation;

**No-** Go to step 5.

5. Do GP 6.4 to check S47 Closer Full Open.

**This clears the fault**

**Yes-** Return to normal operation;

**No-** Go to Step 6.

6. Do GP 6.3.5 FIRMWARE UPGRADE Procedure to Re-flash the firmware for eWire.

**This clears the fault**

**Yes-** Return to normal operation;

**No-** Go to Step 7

7. Do REP 11.2 "B" Main Control Board Replacement.

**This clears the fault**

**Yes-** Return to normal operation;

**No-** Escalate to second level

### **RTP 5.11 J381- CLOSER STAGED TIMEOUT**

J381 is triggered when it takes longer than the specified time for the Closer to reach the S49 Closer Staged Position.

Do the steps in RTP 5.6 [J375- BOOK DROP POSITION TIMEOUT](#)

### **RTP 5.12 J382- FULL CLOSE TIMEOUT**

J382 is triggered when it takes longer than the specified time for the number of encoder counts to reach the value for the Upper Jaw to be at its Full Closed position for the currently loaded element size.

Do the steps in RTP 5.26 [J396- CLOSER RE-HOME ENCODER TIMEOUT](#)

### **RTP 5.13 J383- FULL OPEN TIMEOUT**

J383 is triggered if it takes longer than the specified time for a change of state of S47 Closer Full Open to indicate the Upper Jaw is at its home position.

Do the steps in RTP 5.10 [J380- CLOSER JAWS HOME TIMEOUT](#)

#### RTP 5.14 J384- HOLDER AT CLOSER STEPS TIMEOUT

J384 is triggered when it takes longer than the specified time for the Holder to reach S36 Holder at Closer.

Do the steps in RTP 5.16 [J386- HOLDER FULL RIGHT TIMEOUT](#)

#### RTP 5.15 J385- HOLDER DETECT AT GATE TIMEOUT

J385 is triggered when it takes longer than the specified time for the Holder to reach S39 Holder Detect at Reverse Gate when the Holder Linear Motor M15 moves in the reverse direction.

1. Do GP 6.4 to check S39 Holder at Reverse gate sensor

**This clears the fault**

**Yes-** Return to normal operation;

**No-** Go to Step 2

2. Check the Condition of the Holder Linear Drive Belt- Front and Rear (PL 5.21).

**The timing belt is in good condition. There are no missing teeth and the belt is not frayed**

**Yes-** Go to Step 3;

**No-** Replace the damaged timing belt (REP 8.11, 8.12) and resume operation

3. Check the tension of the Holder Linear Drive Belt - Front and Rear (ADJ 1.6).

**The tension of both timing belts are good**

**Yes-** Go to Step 4;

**No-** Do ADJ 1.6 to set the belt tension and resume operation

4. Visually check if the rollers of the Holder are centered in the cam tracks.

**The rollers are centered in the cam tracks**

**Yes-** Go to Step 5;

**No-** Loosen the cam track assembly and bring the roller inside the cam track. Resume operation

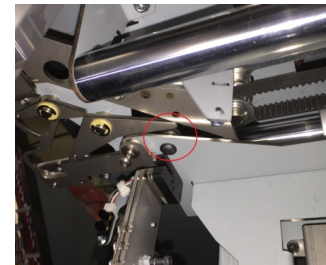

5. Check if the set screws on all the six pulleys associated with the Holder linear drive are tight

**The set screws are tight**

**Yes-** Go to Step 6;

**No-** Tighten the loose set screw(s) and resume operation

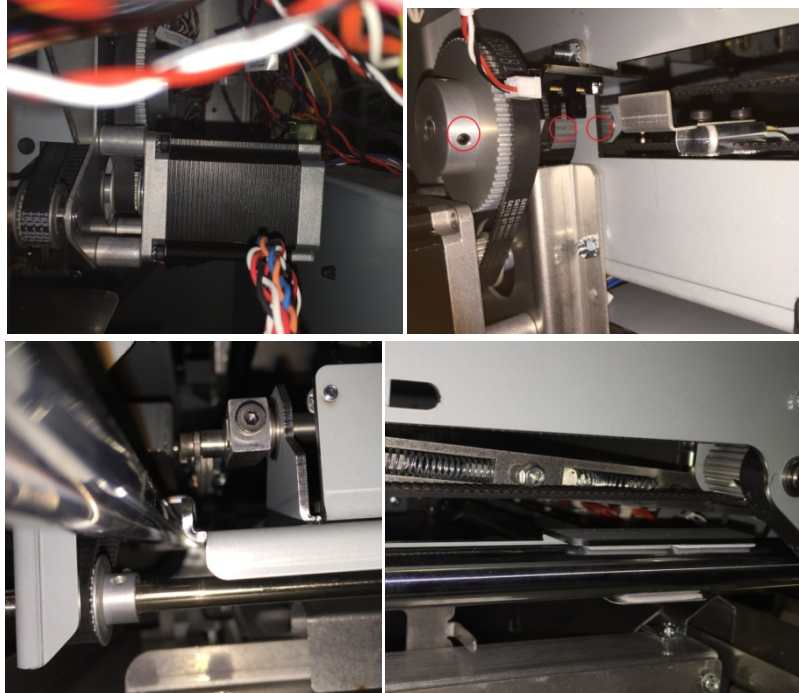

6. Manually move the Holder linear mechanism and watch if the sheet metal feature blocks/unblocks S39 Holder at Reverse Gates sensor.

**The sensor is blocked/unblocked properly**

**Yes-** Go to Step 7;

**No-** Escalate to second level

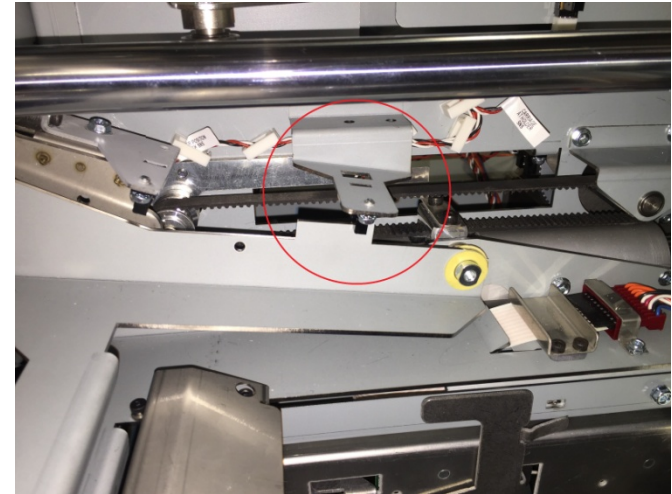

7. Do GP 6.5 to check M15 Holder linear drive motor

**This clears the fault**

**Yes-** Return to normal operation;

**No-** Go to step 8

8. Inspect the springs for the Holder gates (PL 5.21).

**Holder gates springs are present and not damaged**

**Yes-** Go to Step 9;

**No-** Replace the missing/damaged spring

9. Do GP 6.3.5 FIRMWARE UPGRADE Procedure to Re-flash the firmware for eWire.

**This clears the fault**

**Yes-** Return to normal operation;

**No-** Go to Step 10



10. Do REP 11.2 "B" Main Control Board Replacement.

**This clears the fault**

**Yes-** Return to normal operation;

**No-** Escalate to second level

### **RTP 5.16 J386- HOLDER FULL RIGHT TIMEOUT**

J386 is triggered when it takes longer than the specified time for the Holder to reach S36 Holder Position at Closer.

1. Do GP 6.5 to check S36 Holder at Position at Closer.

**This clears the fault**

**Yes-** Return to normal operation;

**No-** Go to Step 2

2. Check the Condition of the Holder Linear Drive Belt- Front and Rear (PL 5.21)

**The timing belt is in good condition. There are no missing teeth and the belt is not frayed**

**Yes-** Go to Step 3;

**No-** Replace the damaged timing belt (REP 8.11, 8.12) and resume operation

3. Check the tension of the Holder Linear Drive Belt- Front and Rear (ADJ 1.6)

**The tension of the timing belts is good**

**Yes-** Go to Step 4

**No-** Do ADJ 1.6 to set the belt tension and resume operation

4. Visually check if the rollers of the Holder are centered in the cam tracks.

**The rollers are centered in the cam tracks**

**Yes-** Go to Step 5

**No-** Loosen the cam track assembly and bring the roller inside the cam track. Resume operation

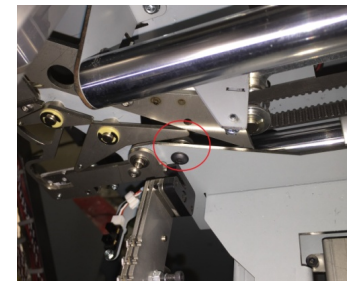

5. Check if the set screws on all the six pulleys associated with the Holder linear drive are tight

**The set screws are tight**

**Yes-** Go to Step 6

**No-** Tighten the loose set screw(s) and resume operation

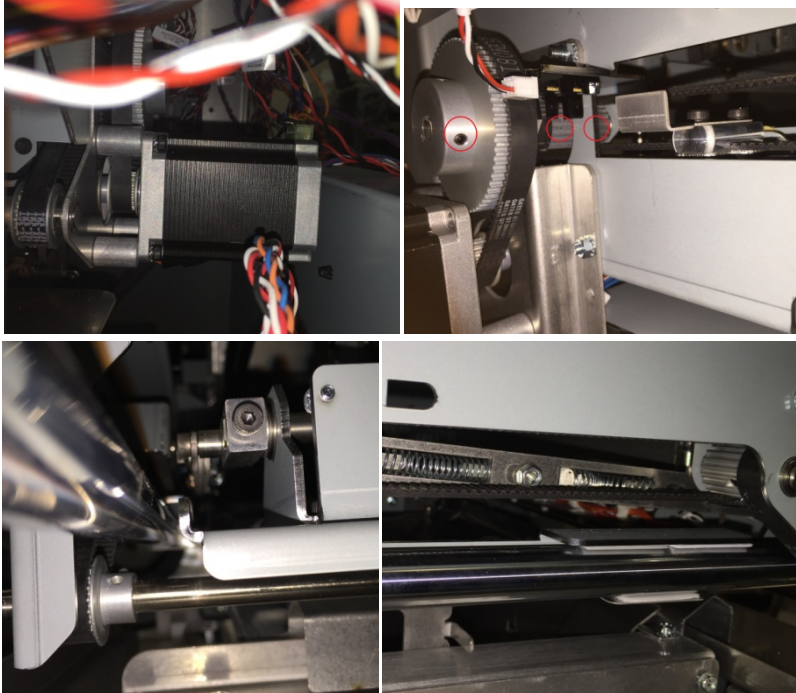

6. Manually move the Holder linear mechanism and watch if S36 Holder at Closer position sensor is properly blocked/unblocked.

**The sensor is blocked/unblocked properly**

**Yes-** Go to Step 7;

**No-** Escalate to second level

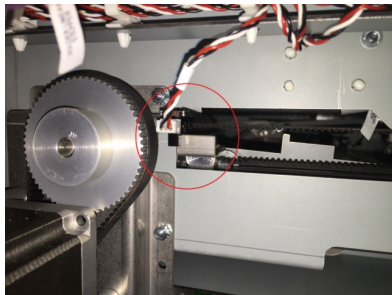

7. Do GP 6.5 to check M15 Holder linear drive motor

**This clears the fault**

**Yes-** Return to normal operation;

**No-** Go to step 8

8. Inspect the springs for the Holder gates (PL 5.21).

**Holder gates springs are present and not damaged**

**Yes-** Go to Step 9;

**No-** Replace the missing/damaged spring

9. Do GP 6.3.5 FIRMWARE UPGRADE Procedure to Re-flash the firmware for eWire.

**This clears the fault**

**Yes-** Return to normal operation;

**No-** Go to Step 10

10. Do REP 11.2 "B" Main Control Board Replacement.

**This clears the fault**

**Yes-** Return to normal operation;

**No-** Escalate to second level

### **RTP 5.17 J387- HOLDER HOME TIMEOUT**

J387 is triggered when it takes longer than the specified time for the Holder to reach S40 Holder Near Element Feeder when moving toward the Element Feeder Drawer.

1. Do the steps in RTP 5.4 [J373- S40 AT BOOK DROP POSITION TIMEOUT](#)

### **RTP 5.18 J388- HOLDER NOT HOME TIMEOUT**

J388 is triggered when it takes longer than the specified time for the Holder to leave S40 Holder Near Element Feeder after collecting an element.

- Do the steps in RTP 5.4 [J373- S40 AT BOOK DROP POSITION TIMEOUT](#)

### RTP 5.19 J389- HOLDER PAST HOME TIMEOUT

J389 is triggered when a firmware fault occurs causing the Holder to fail to move the proper number of steps to its Past Home position.

Do the steps in RTP 5.4 [J373- S40 AT BOOK DROP POSITION TIMEOUT](#)

### RTP 5.20 J390- HOLDER ROTATE HORIZONTAL TIMEOUT

J390 is triggered if it takes longer than the specified time for S35 Holder Rotate Horizontal to get covered when the holder moves to its horizontal position.

1. Do GP 6.4 to check S35 Holder Rotate Horizontal.

**This clears the fault**

**Yes-** Return to normal operation;

**No-** Go to Step 2

2. Do GP 6.5 to check M14 Holder Rotate.

**This clears the fault**

**Yes-** Return to normal operation;

**No-** Go to step 3

3. Check the presence and tightness of the two socket head screws on the Holder Rotate Crank.

**Screws are present and sufficiently tight**

**Yes-** Go to Step 4;

**No-** Tighten the screw and resume normal operation

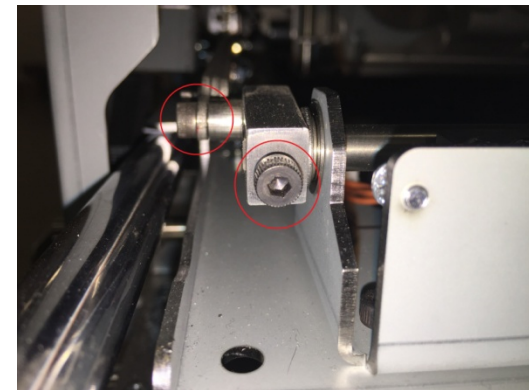

4. Check for the presence and tightness of the fasteners shown in the below image at the Holder Rotate Pivot.

**The fasteners are sufficiently tight**

**Yes-** Go to Step 5;

**No-** Tighten the fasteners and resume normal operation

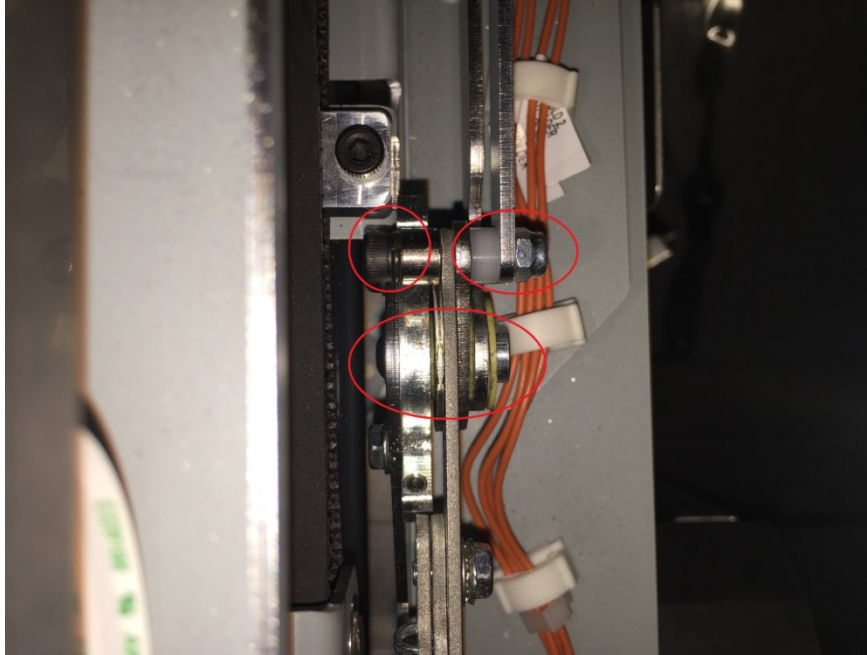

5. Ensure the Front and Rear Hinge Brackets are positioned properly. See below for the hardware diagrams.

**Brackets are secured correctly**

**Yes-** Go to Step 6;

**No-** Replace the missing or damaged components.

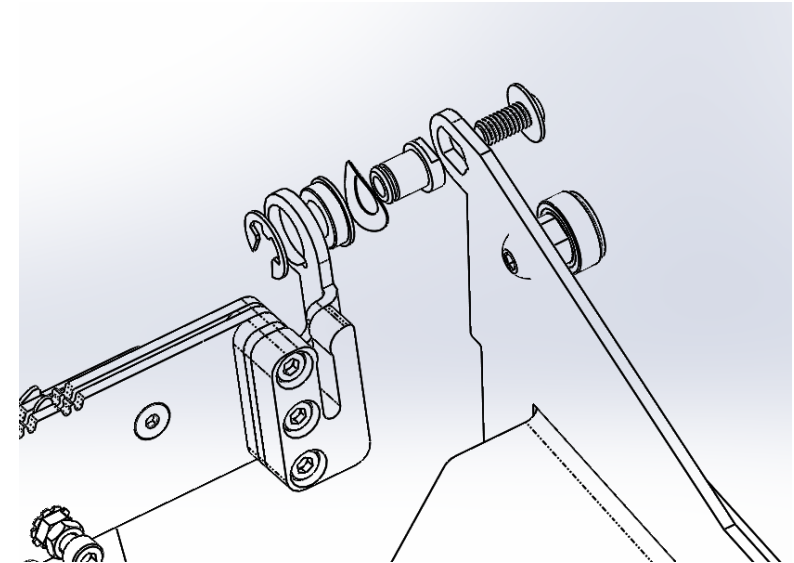
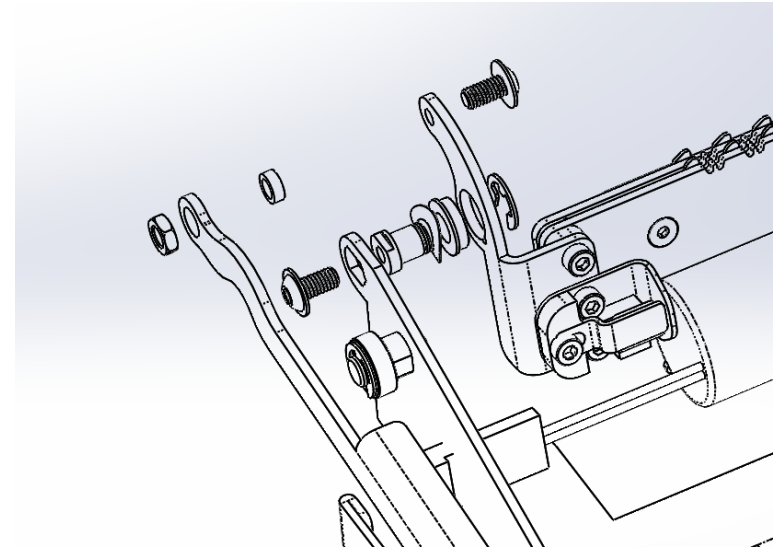

6. Ensure the linkages are not bent/damaged.

**The linkages are not damaged**

**Yes-** Go to Step 7

**No-** Replace the damaged linkage (REP 8.18)

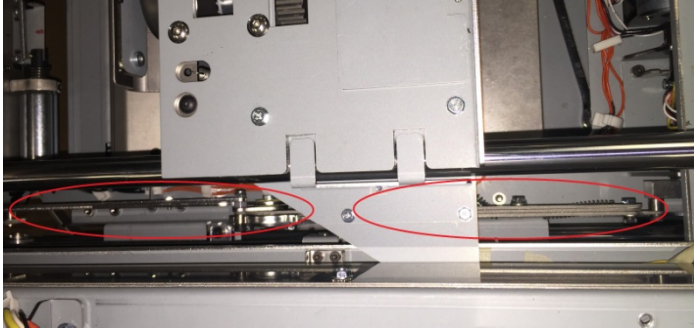

7. Do GP 6.3.5 FIRMWARE UPGRADE Procedure to Re-flash the firmware for eWire.

**This clears the fault**

**Yes-** Return to normal operation;

**No-** Go to Step 8

8. Do REP 11.2 "B" Main Control Board Replacement.

**This clears the fault**

**Yes-** Return to normal operation

**No-** Escalate to second level

### **RTP 5.21 J391- HOLDER ROTATE VERTICAL TIMEOUT**

J391 is triggered if it takes longer than the specified time for S34 Holder Rotate Vertical to get covered when the Holder moves to its vertical position as it moves to its linear Home position.

1. Do GP 6.4 to check S34 Holder Rotate Vertical sensor

**This clears the fault**

**Yes-** Return to normal operation;

**No-** Go to Step 2

2. Do GP 6.5 to check M14 Holder Rotate motor

**This clears the fault**

**Yes-** Return to normal operation;

**No-** Go to step 3

3. Check the presence and tightness of the two socket head screws on the holder rotate crack

**Screws are present and sufficiently tight**

**Yes-** Go to Step 4;

**No-** Tighten the screw and resume normal operation

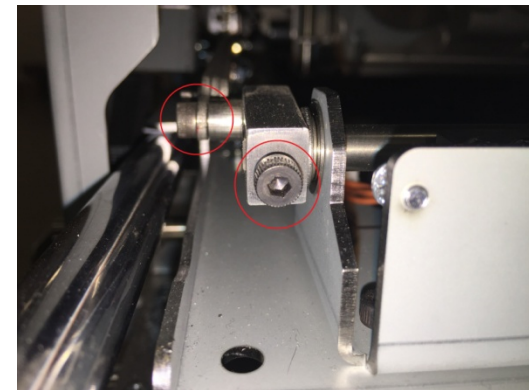

4. Check for the presence and tightness of the fasteners shown in the below image at the Holder rotate pivot

**The fasteners are sufficiently tight**

**Yes-** Go to Step 5;

**No-** Tighten the fasteners and resume normal operation

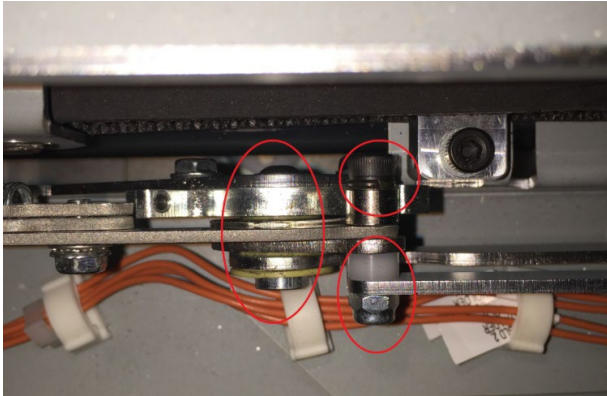

5. Ensure the Front and Rear hinge brackets are positioned properly. See below for the hardware diagrams.

**All the hardware is present**

**Yes-** Go to Step 6;

**No-** Replace the missing components

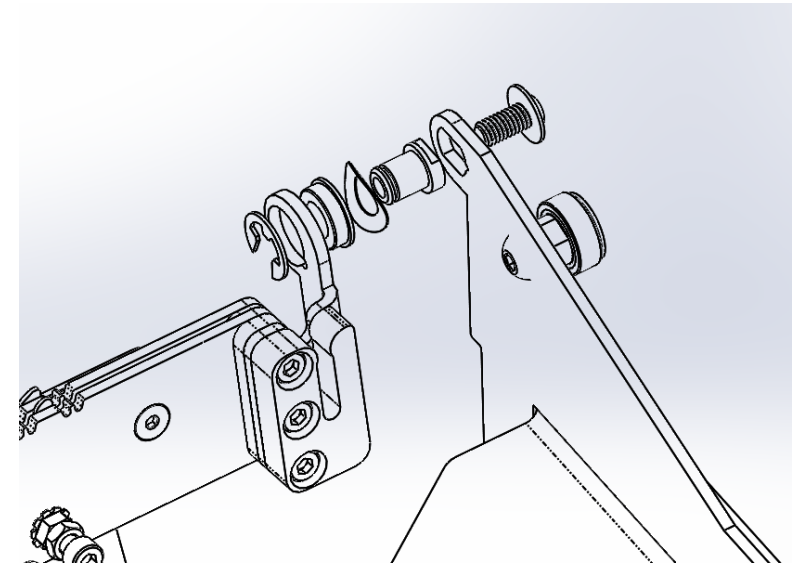
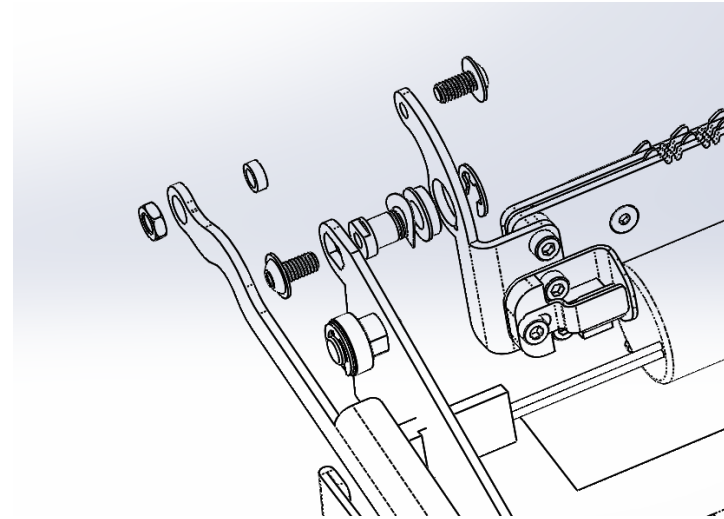

6. Ensure the linkages are not bent/damaged.

**The linkages are not damaged**

**Yes-** Go to Step 7

**No-** Replace the damaged components (REP 8.18)

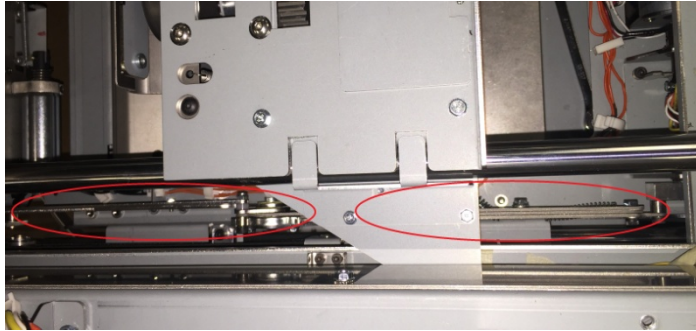

7. Do GP 6.3.5 FIRMWARE UPGRADE Procedure to Re-flash the firmware for eWire.

**This clears the fault**

**Yes-** Return to normal operation;

**No-** Go to Step 8

8. Do REP 11.2 "B" Main Control Board Replacement.

**This clears the fault**

**Yes-** Return to normal operation;

**No-** Escalate to second level

## **RTP 5.22 J392- HOLDER STACK POSITION STEPS TIMEOUT**

J392 is triggered when a firmware fault occurs causing the Holder to fail to move the proper number of steps to its Stack position after leaving S37 Holder Stack Position.

Do the steps in RTP 5.1 [J370- HOLDER AT S37 TIMEOUT](#)



**RTP 5.23 J393- HOLDER WAIT VERTICAL TIMEOUT**

J393 is triggered if it takes longer than the specified time for S34 Holder Rotate Vertical to get covered when the Holder moves to its vertical position as it moves to collect another element.

Do the steps in RTP 5.21 [J391- HOLDER ROTATE VERTICAL TIMEOUT](#)

**RTP 5.24 J394- PARTIAL CLOSE TIMEOUT**

J394 is triggered when it takes longer than the specified time for the number of encoder counts to reach the value for the Upper Jaw to be at its Partial Closed position for the currently loaded element size.

Do the steps in RTP 5.26 [J396- CLOSER RE-HOME ENCODER TIMEOUT](#)

### RTP 5.25 J395- S28 MOTOR STEPS TIMEOUT

J395 is triggered when it takes longer than specified time for the Holder to go to S38 Holder Element position sensor.

Do the steps in RTP 5.2 [J371- S38 HOLDER POSITION ELEMENT TIMEOUT](#)

### RTP 5.26 J396- CLOSER RE-HOME ENCODER TIMEOUT

J396 occurs when the S48 Closer Encoder Sensor does not change state within a specified time after the M20 Closer Motor begins to move.

1. This may be caused by the closer cams being out of phase. A symptom of this would be an increasing level of elements being closed unevenly. To check this, remove the Front Closer Cover and the Top Closer Cover by removing the M4 screws (3)

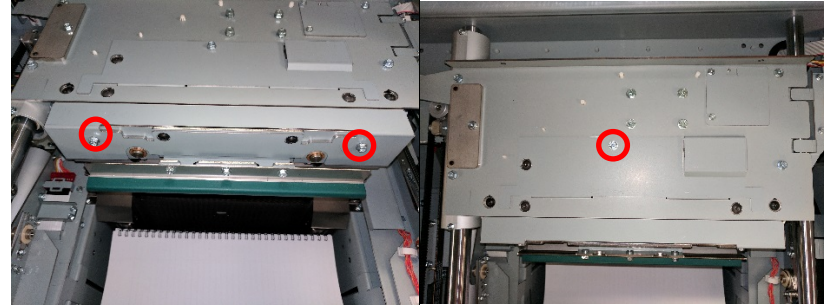

With this cover removed and the cams visible, perform GP 6.3.3 to active M20. Watch the cams rotate.

**Are the cams rotating in phase?**

**Yes** – Go to step 2;

**No** – Perform ADJ 1.11 Closer Cam Phase Adjustment.

2. This jam may occur if more sheets were used in a book than the currently loaded element size can accommodate. Consult Book Quality Section 3.5.1 Book Size and correct the job if needed.

**This clears the fault**

**Yes-** Return to normal operation;

**No-** Go to Step 3

3. Ensure that there are no residual elements or foreign objects in the Closer jaws.

**Closer jaws are free of foreign materials**

**Yes-** Go to Step 6;

**No-** Remove the object(s)

**The jaws were able to be cleared.**

**Yes-** Go to Step 5;

**No-** Go to Step 4

4. Do REP 6.4 to remove the M20 Closer Motor. Rotate the large drive gear by hand to rotate the cams and release any objects stuck between the jaws. Reinstall the Closer Motor and Closer Module.

**Closer jaws are free of foreign materials**

**Yes-** Go to Step 5;

**No-** Escalate to second level

5. Close all covers, and cycle the Element Feeder Door Interlock

**This clears the fault**

**Yes-** Return to normal operation;

**No-** Go to Step 6

6. Remove the M3 Screws (2) holding the Cable Access Cover. Check that the Flat Mylar Closer Cable is plugged in and properly seated in its housing as shown.



**Cable is plugged in and properly seated**

**Yes-** Go to Step 7;

**No-** Plug in the cable close all covers and cycle the Element Feeder Door interlock.

**This clears the fault**

**Yes-** Reinstall the Cable Cover and return to normal operation;

**No-** Go to Step 7.

7. Check the area exposed in step 1 for debris i.e. screws, elements, or other foreign objects

**Closer cam and chain areas are free of foreign objects.**

**Yes-** Go to Step 8.

**No-** Remove the object(s). If the debris is unable to be removed, do REP 6.4 to remove the M20 Closer Motor. Rotate the large drive gear by hand to rotate the cams and chain and release any objects. If the debris is still unable to be removed, escalate to second level.

**This clears the fault**

**Yes-** Reinstall the covers and return to normal operation;

**No-** Go to Step 8.

8. Do GP 6.5 to check M20 Closer Motor.

**This clears the fault**

**Yes-** Return to normal operation;

**No-** Go to step 9.

9. Do GP 6.3.3 Motors Procedure to turn on M20 Closer Motor. Check if the rear cam is turning.

**The rear cam is turning**

**Yes-** Go to Step 10;

**No-** Check if the M5 Screw in the collar on the rear shaft is properly tight. The screw should be tightened to a torque of 8 Nm.

**The screw is properly tightened**

**Yes-** Escalate to second level;

**No-** Tighten the screw to 8 Nm.

**This clears the fault**

**Yes-** Follow the steps in Section 3.1 Element Closing to achieve proper bind quality then return to normal operation;

**No-** Go to step 10.

10. Do GP 6.4 to check S48 Closer Encoder Sensor.

**This clears the fault**

**Yes-** Return to normal operation;

**No-** Go to Step 11.

11. Check that the element size that this jam occurred with is loaded. Do GP 6.3.13 to record the current Partial Close value and then decrease it by 5. Continue running books and decreasing this value until this jam no longer occurs during a job.

**This clears the fault**

**Yes-** Follow the steps in Section 3 - Book Quality to regain quality binds and return to normal operation. Repeat this step if this jam was encountered on any other size elements;

**No-** Reset the Partial Close setting to its initial value and go to Step 12.

12. Do GP 6.3.5 FIRMWARE UPGRADE Procedure to Re-flash the firmware for eWire.

**This clears the fault**

**Yes-** Return to normal operation;

**No-** Go to Step 13

13. Do REP 11.2 "B" Main Control Board Replacement.

**This clears the fault**

**Yes-** Return to normal operation;

**No-** Escalate to second level

## 6 BOOK DRAWER FAULT CODES

### RTP 6.1 J442- DRAWER FULL UP TIMEOUT

J442 is triggered if it takes longer than specified time for the Book drawer to reach its Full Up position (blocking S42 Book drawer Full up position)

1. Do GP 6.4 to check S42 Book Drawer Full Up sensor

**This clears the fault**

**Yes-** Return to normal operation;

**No-** Go to Step 2

2. Check the condition of the Book Drawer Lift Belt. Ensure that the belt is not frayed or missing any teeth. Ensure that all screws are tight and no parts are loose in the belt mechanism

**Belt and Pulleys are in good condition**

**Yes-** Go to Step 3

**No-** Replace the Book Drawer Belt or Pulley.

3. Inspect the Book Tray Drive Motor Belt (PL 5.24). Ensure that the belt is not frayed or missing any teeth. Check the set screws on the Drive Belt Pulleys to ensure all set screws are tight.

**Belt and Pulleys are in good condition**

**Yes-** Go to Step 4

**No-** Replace the Book Tray Drive Motor Belt

4. Do GP 6.5 to check M19 Book drawer elevation motor

**This clears the fault**

**Yes-** Resume normal operation;

**No-** Go to Step 5

5. Do 6.3.5 FIRMWARE UPGRADE Procedure to Re-flash the firmware for eWire.

**This clears the fault**

**Yes-** Return to normal operation;

**No-** Go to Step 8

6. Do REP 11.2 "B" Main Control Board Replacement.

**This clears the fault**

**Yes-** Return to normal operation;

**No-** Escalate to second level

## **RTP 6.2 J443- DRAWER FULL DOWN TIMEOUT**

J443 is triggered if it takes longer than the specified time for S42 a & b to become unblocked when the book drawer is going down.

1. Do GP 6.4 to check S42 Book Drawer Full Down sensor

**This clears the fault**

**Yes-** Return to normal operation;

**No-** Go to Step 2

2. Check the condition of the Book Drawer Lift Belt. Ensure that the belt is not frayed or missing any teeth. Ensure that all screws are tight and no parts are loose in the belt mechanism

**Belt and Pulleys are in good condition**

**Yes-** Go to Step 3

**No-** Replace the Book Drawer Belt or Pulley.

3. Inspect the Book Tray Drive Motor Belt (PL 5.24). Ensure that the belt is not frayed or missing any teeth. Check the set screws on the Drive Belt Pulleys to ensure all set screws are tight.

**Belt and Pulleys are in good condition**

**Yes-** Go to Step 4

**No-** Replace the Book Tray Drive Motor Belt

4. Do GP 6.5 to check M19 Book drawer elevation motor

**This clears the fault**

**Yes-** Resume normal operation;

**No-** Go to Step 5

5. Do 6.3.6 FIRMWARE UPGRADE Procedure to Re-flash the firmware for eWire.

**This clears the fault**

**Yes-** Return to normal operation;

**No-** Go to Step 8

6. Do REP 11.2 Main Control Board B Replacement

**This clears the fault**

**Yes-** Return to normal operation;

**No-** Escalate to second level

### **RTP 6.3 J445- BOOK DRAWER FULL**

The maximum number of books for each element size is predetermined in the firmware. As the system processes every book, the counter keeps increasing and when it reaches the max count, the LCD screen displays J445 BOOK DRAWER FULL.

When the book drawer full message is displayed, every book in the book drawer must be removed to clear the message. For example, if there are 10 books in the drawer, all 10 books will have to be removed to clear the message.

Every time the book drawer is opened and closed, the system checks for the presence of residual books. If there are no books present (which could also include the case of the operator emptying the book drawer prior to the Full message being displayed), the count is reset and the machine will process books to the maximum capacity.

Book drawer Full message is also displayed if S42 Book Drawer Full Up sensor AND S43 Book Drawer Full Down sensor are covered at the same time.

If the Book drawer message is displayed erroneously, follow the below procedure for troubleshooting:

1. Do GP 6.4 to check S45 Book Drawer Empty sensor  
**This clears the fault.**  
**Yes-** Return to normal operation;  
**No-** Go to Step 2
2. Do 6.3.5 FIRMWARE UPGRADE Procedure to Re-flash the firmware for eWire.  
**This clears the fault**  
**Yes-** Return to normal operation;  
**No-** Escalate to second level

### **RTP 6.4 J451- S42 & S43 BLOCKED AT SAME TIME**

J451 is triggered if S42 Book Drawer Full Up sensor AND S43 Book Drawer Full Down sensor are covered at the same time.

Follow the procedure in **RTP 6.1 and 6.2**

## **RTP 6.5 J452- BOOK DRAWER OPENED DURING JOB**

J452 will occur when the Book Tray is opened during operation. Open the Book Tray when the eWire LCD no longer displays "RUNNING".

1. Firmly close the Book Tray and restart the Job.

**This clears the fault**

**Yes-** Return to normal operation;

**No-** Go to step 2

2. If the Close Tray message occurs erroneously even when the tray is shut, refer to ADJ 1.7 to adjust the Book Tray interlock flag.

**This clears the fault**

**Yes-** Return to normal operation;

**No-** Go to step 3

3. If Close Tray occurs continuously, refer to RTP 1.03, Section 3.

**This clears the fault**

**Yes-** Return to normal operation;

**No-** Escalate to second level.



**Notes:**

### Section Contents

Title	Page
3.1 Element Closing .....	3
3.1.1 Element Unevenly Closed.....	3
3.1.2 Element Insufficiently Closed .....	3
3.1.3 Element Over Closed .....	3
3.2 Punched Sheet Quality .....	4
3.2.1 Punched Hole Specifications .....	4
3.3 Sheets not Hooking.....	5
3.3.1 Introduction.....	5
3.3.2 Troubleshooting Steps .....	5
3.3.3 Common Spool Damage.....	6
3.4 Element Roundness.....	8
3.4.1 Theory of Operation .....	8
3.4.2 Troubleshooting Steps .....	8
3.5 Book Composition .....	9
3.5.1 Book Size .....	10
3.5.2 Curl.....	10

This page intentionally left blank.

### 3.1 Element Closing

Use the following procedure to correct books that are over-closed or under-closed by the eWire. To determine if an element is over-closed or under-closed, refer to the diagram below.

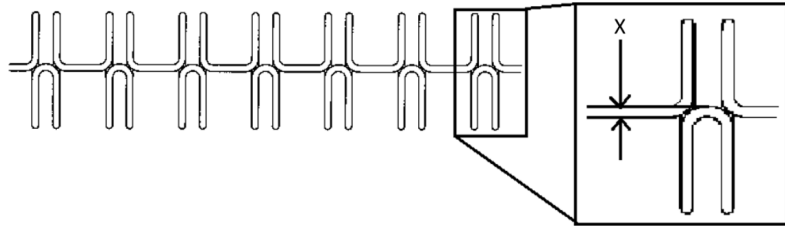

Dimension X Max.	2.00mm
Dimension x Min.	0.25mm

#### 3.1.1 Element Unevenly Closed

The element is considered unevenly closed when The "X" dimension on one side of the binding varies from the "X" dimension on the other side of the binding. Often one side will be properly closed while the other is either insufficiently closed or overly closed.

1. Do ADJ 1.11 Closer Cam Phase Adjustment

#### 3.1.2 Element Insufficiently Closed

The element is considered under-closed if it is possible to pull a sheet out of the twin loop binding by tugging on the end of the sheet. An element is also considered under-closed if dimension "X" above is less than 0.25 mm. The primary cause of under-closed books is insufficient travel of the Closer jaws. To correct under-closure, follow the steps below.

1. DO GP 6.2.2 to access the CLOSING menu. Note the current value.
2. Increase the value by one and exit the Settings Menu.
3. Run another set of books and re-measure the wire loop overlap. If the new book meets the spec, return to normal operation.
4. If the new book is still under-closed, repeat Steps 2 and 3.

#### 3.1.3 Element Over Closed

The element is considered over-closed if Dimension X in the diagram above exceeds 2 mm. An over-closed element may also appear to be oval shaped, instead of round. The primary cause of an over-closed book is if the Closer jaws travel too far during book closing. To correct over-closure, follow the steps below.

1. DO GP 6.2.2 to access the CLOSING menu. Note the current value.
2. Decrease the value by one and exit the Settings Menu.
3. Run another set of books and re-measure the wire loop overlap. Visually inspect the loops to ensure that they are round. If the new book meets the spec, return to normal operation.
4. If the new book is still over-closed, repeat Steps 2 and 3.

Example of Over-Closed Book:

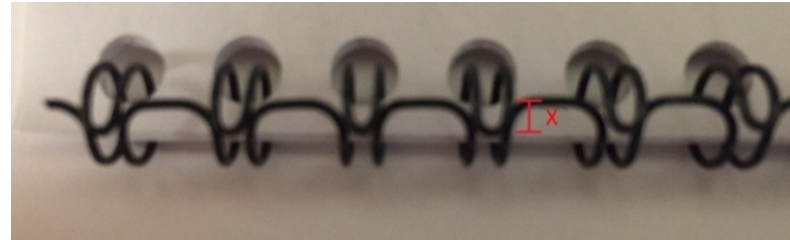

Example of Oval-Shaped Loops due to Over Closure:



### 3.2 Punched Sheet Quality

All sheets must be punched by the GBC MFPP prior to being bound into books by the eWire. If punch alignment, skew, or backgauge does not meet the specification in Section 3.2.1, it may be necessary to make adjustments to the MFPP in order to ensure proper function of eWire. Use the following procedure to check the positions of the punched holes.

1. Run a sheet through the punch without binding. Do not perform this test with A5 or STMT, the A4 and LTR adjustment will correct issues with all sizes.
2. Place the sheet on the Punched Hole Position Check Tool found on the inside of the Feeder Door or in the following pages.

3. Position the corner of the sheet on the Punched Hole Position Check Tool as shown depending on what size paper you are printing with (A4 align with right corner, LTR align with left corner). The following image shows a square punched sheet. If you are using a circular punch use the appropriate markings above. Position the edge of a sheet so that the horizontal and vertical black lines are completely visible, and check if the black circles or squares are completely visible through the punched holes.

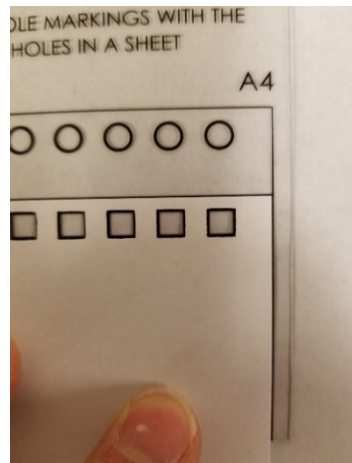

4. It should be obvious if the punch backgauge, alignment, or skew are not set correctly or if the holes have fuzzy edges or chads. Refer to the MFPP Service Manual to correct these issues before proceeding.
5. If sheets are being fed from a separate device downstream of the printer (i.e. an inserter), verify correct punched hole positions on those sheets as well. Refer to the MFPP Service Manual to correct any issues before proceeding.
6. If using tabs or clear covers, verify correct punched hole positions on those sheets as well. Refer to the MFPP Service Manual to correct any issues before proceeding.
7. If the backgauge, alignment, and skew are set correctly on the MFPP for all media being used return to the troubleshooting procedure that guided you here. Note that if a different die is used

or if the docking position of the MFPP is changed these steps may need to be repeated.

#### 3.2.1 Punched Hole Specifications

- A) A4 Alignment = 6.3mm  
LTR Alignment = 6.0mm
- B) Back gage = 1.85mm
- C) Hole Diameter = 5mm
- D) Hole length and width = 5mm

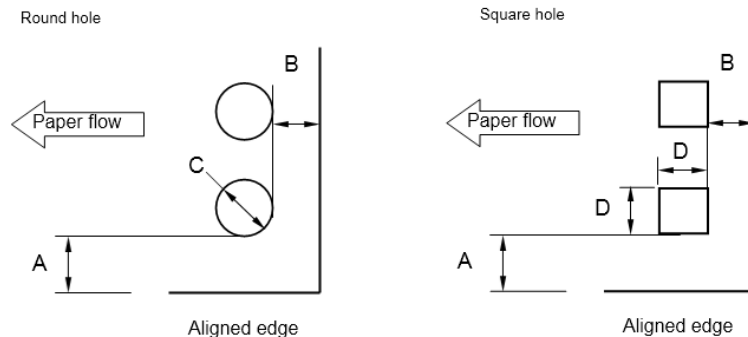

### 3.3 Sheets not Hooking

#### 3.3.1 Introduction

The core function of eWire is the hooking of punched sheets onto a wire loop, and then closing the wire loop to create a bound book. This section will lay out the troubleshooting steps for when sheets are not accurately being hooked on the twin loop wire tips.

A problem with hooking will result in poor book quality. In some cases, it will also create a Jam code. J244 (Sheets left in stack area) or J202/J203 (Stay Jam Area 2) are the most likely Jams to be caused as a result of poor hooking.

Note that there are multiple Jam codes that could be triggered by an unsuccessful hooking operation. If a Jam code is repeatedly seen that does not have an obvious root cause, following the steps in this section may help lead to a resolution.

#### 3.3.2 Troubleshooting Steps

Follow the procedure below to correct a 'not hooking' issue on eWire. If a change to eWire is made as a result of one of the troubleshooting steps below, run additional books to determine if the change has resolved the problem.

1. Verify that the eWire is properly docked to the upstream device and that there is no misalignment between the devices. Confirm that the sheets being fed into the eWire are aligned with the sheet location marks on eWire. Refer to Section 8 Installation for more detail.
2. Check the printed sheets for excessive curl. Refer to Section 3.5.2. If the curl is too large, eWire will be unable to properly stack and hook the sheets. If necessary, adjust printer settings to reduce curl.
3. Do the steps in Section 3.2 to verify that the punched holes' positions are accurate and precise and that the holes are punched cleanly.
4. Poor hooking can occur when the sheet quantity is too high or paper stock is too heavy or too light. Refer to Section 3.5 for the maximum allowable number of sheets in each element size and allowable media.
5. Do GP 6.4 to check S3, S18, and S19
6. Do GP 6.5 to check M5 to M7

7. Do GP 6.6 to check L5 to L8
8. Install a new, unopened spool of the same size element. If this solves the issue, visually inspect the wire on the spool that was removed for damage or defects; refer to Section 3.3.3.
9. If element has not transferred or is not hooked completely follow the steps below. If the element has transferred correctly continue with step 16.
10. Visually Inspect the Element Feed Belt for damage. Observe each tooth to ensure there are no large cracks or gouges. Do REP 3.6 if damage is observed.
11. Do ADJ 1.1 to check the Element Skew and adjust if needed.
12. Do ADJ 1.3 to check the Holder mating to the Element Feeder.
13. Do ADJ 1.14 to check the Element Xfer Position
14. Do ADJ 1.19 to check top cover latch position
15. Do ADJ 1.10 to verify the Element wire tip position is correct.
16. Do ADJ 1.8 to verify the Deflector timing and eWire Alignment and Skew settings.

For steps 10 to 16, if a change is made, ADJ 1.8 will need to be repeated to correct the Deflector timing and eWire Alignment and Skew settings.

17. Do ADJ 1.17 to check and correct the Element Feed Belt tension.

Visually inspect the Holder Rotate Linkage. Ensure that no parts in the linkage are damaged, loose, or bent. Refer to ADJ 1.9 for info on checking the Holder Rotate function.

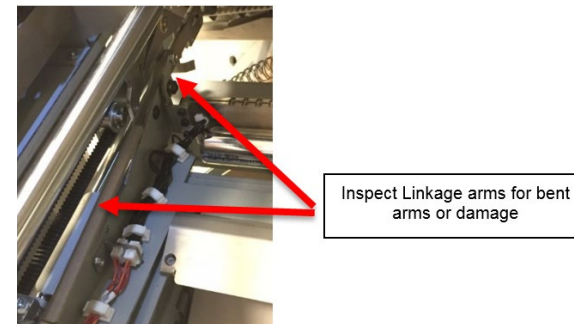

18. Return to the RTP that directed you here.

### 3.3.3 Common Spool Damage

The wire on the spool may become damaged when not properly handled. This may cause jams in eWire. In this section there are examples of common issues you may see on a spool. Any damaged wire must be removed using the wire cutters provide. They are located on the inside of the element feeder door. When cutting the wire, cut the wire in the center of the larger loop as shown below. Excess paper can then be removed, leaving 12 inches (30 cm) past the new end of the wire. The spool can then be reinstalled.

#### Cutting Wire

When part of the spool of wire is damaged, it must be removed using the wire cutters provide. They are located on the inside of the element feeder door. When cutting the wire, cut the wire in the center of the larger loop as shown below. Excess paper can then be removed, leaving 12 inches (30 cm) past the new end of the wire.



#### Stretched Wire

Wire can become stretched when installing or removing a spool from the machine, it may also become stretched due to wire jams. If any length of wire is stretched like shown below, use the wire cutters provided to cut that section off. Wire is considered stretched if the loops are no longer parallel to each other. The wire outlined in red is an example of stretched wire.

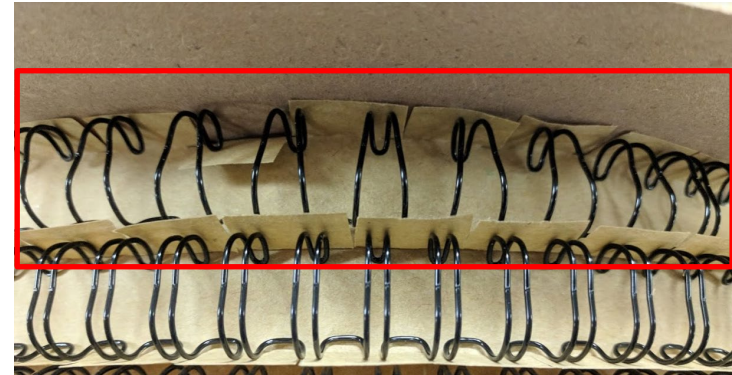

#### Crushed Wire

Wire can become crushed when the spool is miss handled. Below is an example of a crushed length of wire. Crushed wire must be cut off and discarded.

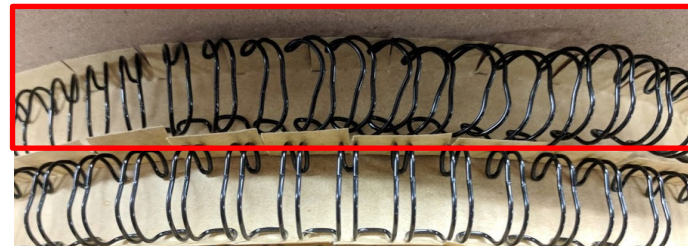

### Tangled Wire

If the spool is stored without the wire properly secured with the magnet strips, the wire may become entangled. This can be fixed by carefully separating the entangled rows. Once untangled, check that no other damage is present before using this spool. The most common damage occurring from this is a stretched wire (see above).

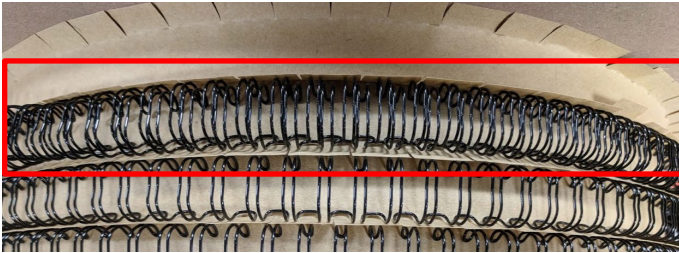

### Loose Element

The eWire™ will prompt the user to clear extra elements from 3b after a stoppage occurs. If this is not done the element may fall into the element feeder area and cause a wire jam to occur. The wire could fall on top of the spool as shown below.



The wire may fall to the bottom of the element drawer.



If this occurs, carefully remove the loose element/s and check the spool for damage. The most common damage occurring from this is stretched wire (see above).



## 3.4 Element Roundness

### 3.4.1 Theory of Operation

For good roundness to be achieved, the tips of the element wire must be in contact with the rear face of the Closer during closing operation. If the wire tips are skewed or offset from the wall prior to closing, poor roundness can occur.

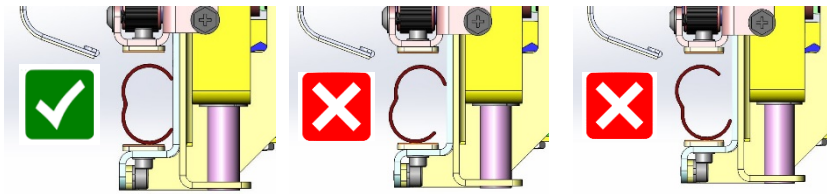

### 3.4.2 Troubleshooting Steps

1. Roundness problems can be caused by an over-closed element. If it seems that the Element may be over-closed, refer to the steps in 3.1 correct it.
2. Confirm that you are not sending too many sheets. Try sending a book with the number of sheets indicated in Section 3.3.2, Step 2. See if the problem still occurs.
3. Check the printed sheets for excessive curl. If the curl is too large, eWire will be unable to properly process the sheets. If necessary, adjust printer settings to reduce curl.
4. Roundness problems can also occur if all sheets on the book are not hooked properly. If there are both hooking and roundness issues, refer to the steps in 3.3 to correct the hooking issues before proceeding to the next steps.
5. If the surface on the Closer jaws appears to be worn, replace the closer jaw insert plates.
6. While making a book, watch the machine carefully, and open the top cover after the Holder has transferred the element to the Closer, but before the close cycle is completed. By doing so, you should be able to look from the front and back to identify if the wire tips are not touching the back wall of the Closer.
7. If you are experiencing roundness issues with F size elements, perform ADJ 1.24 F Size Mac Capacity Closer Adjustment

8. If the element tips are not touching the back wall of the Closer, it is possible to increase the distance the Closer travels to pick up the element from the holder. Do GP 6.1.6 to adjust the Closer to Holder value and increment by 10.
9. If incrementing the Closer to Holder value by 10 made a small improvement but it is still not round, try incrementing by an additional 10. If incrementing the value made the problem worse, try a -10 adjustment from the original value.
10. Repeat Steps 6-8 to identify the best possible value for Closer to Holder value.
11. If the element appears to be angled prior to close (See pictures in 3.4.1), it may be necessary to adjust the Holder horizontal position. Refer to ADJ 1.9 for instructions on how to adjust the Holder.
12. Return to the RTP that directed you here.

### 3.5 Book Composition

Cover-sheet order		Rear Cover (Clear cover) Front Cover Sheets 1-N
Paper weight	Plain	75gsm – 300gsm (20lb bond – 100lb cover)
	Coated	115gsm – 300gsm (32lb bond – 110lb cover)
	Tabs	176gsm – 216gsm
Sheet size	Clear Cover	7 mil anti-static material
	US sizes	LTR 8.5 x 11 in STMT 5.5 x 8.5 In
Tabbed stock weight	ISO sizes	A4 297 x 210 mm A5 210 x 148 mm
	US sizes	LTR - 3,5,8,10 tabs
Tab width	ISO sizes	A4 - 5,10 tabs
		Maximum 13mm
Tabbed stock orientation		Tabs must be leading on long edge
Sheet size tolerance		±0.75mm (0.03")

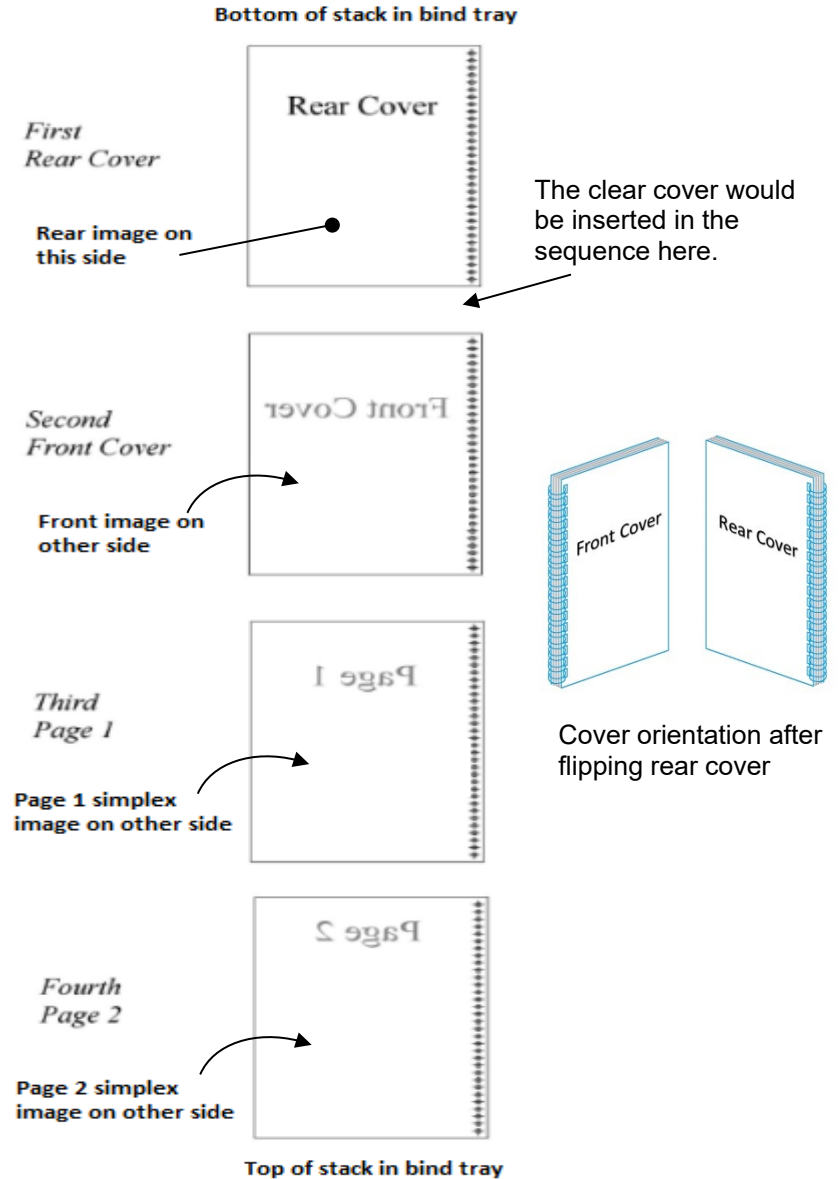

### 3.5.1 Book Size

Element Size	Sheet Capacity*	Max Document Thickness (mm)
A	15-30	3
B	31-50	5
C	51-60	6
D	61-70	7
E	71-80	8
F	81-100	10

\*Sheet capacity based on 20 lb. (75/80gsm) paper, subtract 10 sheets to accommodate front and rear covers of max 300gsm

### 3.5.2 Curl

When laid on a flat surface, no edge of the paper should be higher than 3/8in (10mm) dimension y below.



## Section Contents

<b>1. External Covers</b>	<b>4-4</b>
REP 1.1 Top Cover Replacement.....	4-4
REP 1.2 Element Feeder Door Replacement .....	4-5
REP 1.3 Door Bottom Hinge Bracket Replacement.....	4-6
REP 1.4 Door Top Hinge Bracket Replacement .....	4-6
REP 1.5 Back Cover Replacement .....	4-7
REP 1.6 Side Cover Replacement.....	4-8
REP 1.7 Book Tray Door Replacement .....	4-8
REP 1.8 Front Cover Replacement.....	4-10
REP 1.9 LCD Display Replacement.....	4-11
REP 1.10 LCD Membrane Switch Panel Replacement .....	4-12
REP 1.11 Caster Replacement .....	4-13
<b>2. Paper Transport</b>	<b>4-14</b>
REP 2.1 Drive Roller Replacement – Paper Path.....	4-14
REP 2.2 Drive Roller Replacement – Steering Module.....	4-15
REP 2.3 Drive Roller Bearing Replacement .....	4-16
REP 2.4 Idler Roller Replacement, Paper Path .....	4-17
REP 2.5 Idler Roller Replacement, Steering Module .....	4-18
REP 2.6 Belt Drive Idler Pulley Replacement .....	4-19
REP 2.7 Belt Drive Timing Pulley Replacement .....	4-20
REP 2.8 Bypass Timing Belt #1 Replacement.....	4-21
REP 2.9 Bypass Timing Belt #2 Replacement.....	4-22
REP 2.10 Stepper and Mount Assembly Replacement .....	4-23
REP 2.11 Stepper Motor Pulley Replacement.....	4-24
REP 2.12 Timing Belt Tensioner Replacement.....	4-24
REP 2.13 Bypass Sensor Replacement, S1, S4, S5 & S16 .....	4-25
REP 2.14 Skew Measurement Sensor Replacement, S6-S10 .....	4-26
REP 2.15 Alignment Sensor Replacement, S12, S13 & S15 .....	4-27
REP 2.16 Alignment Sensor Replacement, S41.....	4-28
REP 2.17 Motor Driver (Stepper Driver) Replacement, M1 and M2	4-28

## 4. Repairs and Adjustment Procedures

Title	Page
REP 2.18 Solenoid Replacement, Diverter Solenoid (L1).....	4-30
REP 2.19 Solenoid Replacement, Disengaging Roller #1 and #2 (L2 & L3) .....	4-32
REP 2.20 Solenoid Replacement, Disengaging Roller #3 (L4).....	4-33
REP 2.21 Steering Module Replacement.....	4-35
REP 2.22 Steering Motor Replacement, M16 and M17 .....	4-36
REP 2.23 Alignment Motor Replacement, M18.....	4-37
REP 2.24 Motor Driver (Stepper Driver) Replacement, M4, M16, M17, and M18 .....	4-38
REP 2.25 Anti-Static Brush Replacement .....	4-39
REP 2.26 Upper Transport Latch Replacement.....	4-40
REP 2.27 Lower Transport Latch Replacement.....	4-41
REP 2.28 M4 Motor Replacement.....	4-42
<b>3. Element Feeder</b>	<b>4-44</b>
REP 3.1 Element Slack Sensor Replacement – S20 .....	4-44
REP 3.2 Element Detect at Pyramid Sensor Replacement – S22 ..	4-45
REP 3.3 Element Belt Home Sensor Replacement – S25 .....	4-47
REP 3.4 Spool Detect Sensor Replacement – S26-S30.....	4-49
REP 3.5 Spool Near-Empty Sensor Replacement – S50.....	4-50
REP 3.6 Element Feeder Belt Replacement .....	4-51
REP 3.7 Element Feed Belt Motor Replacement, M10.....	4-52
REP 3.8 Element Feed Sprocket Motor Replacement, M9 .....	4-54
REP 3.9 Spool Rewind Drive Assembly Replacement, M8.....	4-55
REP 3.10 Element Feed Track Assembly Replacement.....	4-59
REP 3.11 Element Feed Belt Idler Replacement .....	4-59
REP 3.12 Element Sprocket Nose Replacement .....	4-60
REP 3.13 Element Engagement Guide Replacement.....	4-62
REP 3.14 Knife Module Replacement.....	4-63
REP 3.14.1 Element Detect at Knife Sensor Replacement S21 ...	4-66
REP 3.14.2 Knife Home Sensor Replacement S23 .....	4-68
REP 3.14.3 Knife Anvil and Blade Replacement .....	4-70

REP 3.15 Element Transfer Module Replacement.....	4-71
REP 3.15.1 Element Pushover Encoder Sensor Replacement S31 & 74	
REP 3.15.2 Pushover Home Sensor Replacement S24 .....	4-75
REP 3.15.3 Expanding T Home and Out Sensor Replacement S32 & S334-75	
REP 3.15.4 Element Transfer Rack Replacement.....	4-76
REP 3.15.5 Horizontal Pushover Cam Replacement.....	4-77
REP 3.15.6 Vertical Pushover Cam Replacement.....	4-78
REP 3.15.7 Pushover Motor Assy Replacement M12.....	4-79
REP 3.15.8 Expanding T Motor Replacement M13 .....	4-80
REP 3.15.9 Expanding T Cam Replacement .....	4-81
REP 3.15.10 Expanding T Spring Replacement.....	4-82
REP 3.15.11 Expanding T Motor Counterbalance Spring Replacement.....	4-83
REP 3.15.12 Expanding T Pushover Spring Replacement .....	4-84
REP 3.15.13 Expanding T, Leading and Trailing Replacement.....	4-85
REP 3.16 Element Feeder Drawer Switch Replacement .....	4-86
REP 3.17 Element Feeder Alignment Pin Bracket Replacement.....	4-87
REP 3.18 Element Slack Detect Lever Assembly Replacement.....	4-88
REP 3.19 Spool Rewind Belt Replacement.....	4-89
<b>4. Vacuum Stacker Module</b>	<b>4-93</b>
REP 4.1 Vacuum Stacker Module Replacement.....	4-93
REP 4.2 Solenoid Replacement, Kickdown Solenoid, Rear (L7) ...	4-95
REP 4.3 Solenoid Replacement, Kickdown Solenoid, Front (L7)...	4-97
REP 4.4 Solenoid Replacement, Drag Finger Solenoid (L6) .....	4-99
REP 4.5 Motor Replacement, Vacuum Stacker Drive (M5).....	4-102
REP 4.6 Idler Pulley Assembly Replacement.....	4-103
REP 4.7 Kick-down Replacement.....	4-105
REP 4.8 Vacuum Stacker Belt Replacement .....	4-107
REP 4.9 Stacker Drive Belt Replacement .....	4-109
REP 4.10 Drag Finger Adhesive Grip Replacement .....	4-110
<b>5. Deflector Module</b>	<b>4-111</b>
REP 5.1 Deflector Module Replacement.....	4-111
REP 5.2 Sensor Replacement, Deflector Position S17 .....	4-113
REP 5.3 Sensor Replacement, Bind Kick-Downs S2 .....	4-114
REP 5.4 Sensor Replacement, Bind Deflect S3.....	4-115

REP 5.5 Bind Path Motor Replacement M3.....	4-116
REP 5.6 Deflector Module Timing Belt Replacement .....	4-117
REP 5.7 Deflector Solenoid Replacement L5.....	4-118
REP 5.8 Deflector Springs Replacement.....	4-120
REP 5.9 Deflector Drive Roller Assembly Replacement .....	4-121
REP 5.10 Deflector Idler Roller Assembly Replacement.....	4-122
<b>6. Closer Module</b>	<b>4-124</b>
REP 6.1 Closer Module Replacement .....	4-124
REP 6.2 Closer Encoder Sensor Replacement S48.....	4-126
REP 6.3 Closer Full Open Sensor Replacement S47 .....	4-127
REP 6.4 Closer Motor Replacement M20.....	4-127
REP 6.5 Closer Jaw Insert Replacement.....	4-129
REP 6.6 Closer Spring Replacement.....	4-130
REP 6.7 Closer Release Solenoid Replacement.....	4-131
REP 6.8 Closer Chain Replacement Procedure .....	4-131
REP 6.9 Disk Encoder Replacement.....	4-132
<b>7. Tappers</b>	<b>4-133</b>
REP 7.1 Front Tapper Assembly Replacement.....	4-133
REP 7.2 Tapper Motor Replacement M6 & M7 .....	4-134
REP 7.3 Tapper Sensor Replacement S18 & S19 .....	4-136
REP 7.4 Front Tapper Spring Replacement .....	4-137
REP 7.5 Tapper Finger Replacement.....	4-137
REP 7.6 Rear Tapper Assembly Replacement .....	4-138
<b>8. Holder Module</b>	<b>4-139</b>
REP 8.1 Closer Staged Sensor and Closer Home Sensor S46 & S49-139	
REP 8.2 Holder Rotate Horizontal and Vertical Sensor S34 & S35 ..	4-140
REP 8.3 Holder Position near Element Sensor S40.....	4-141
REP 8.4 Holder Position Closer and Holder Position Element Sensor S36 and S38.....	4-142
REP 8.5 Holder at Reverse Gate Sensor S39.....	4-143
REP 8.6 Holder Position Stack Sensor S37 .....	4-144
REP 8.7 Holder Linear Motor Replacement M15 .....	4-145

REP 8.8	Holder Linear Motor Replacement M21 .....	4-146	REP 11.4	RFI Filter Replacement .....	4-178
REP 8.9	Holder Rotate Motor Replacement M14 .....	4-147	REP 11.5	Power Switch Replacement .....	4-179
REP 8.10	Closer Linear Drive Belt Replacement.....	4-149	<b>Adjustments</b>		<b>4-180</b>
REP 8.11	Holder Linear Drive Belt – Front Replacement.....	4-150	ADJ 1.1	Element Position Skew Adjustment .....	4-180
REP 8.12	Holder Linear Drive Belt – Rear Replacement .....	4-151	ADJ 1.2	Element Slack Detection Adjustment.....	4-181
REP 8.13	Holder Gates Spring Lower Replacement .....	4-152	ADJ 1.3	Holder Mating To Element Feeder .....	4-183
REP 8.14	Holder Gates Spring Upper Replacement .....	4-153	ADJ 1.4	Element Feed Belt Home Position .....	4-185
REP 8.15	Linear Spring Plate Assembly.....	4-154	ADJ 1.5	Book Drawer Closed Position .....	4-187
REP 8.16	Holder Removal and Replacement.....	4-155	ADJ 1.6	Timing Belt Tension Adjustment .....	4-188
REP 8.17	Holder Lock Sub-Assembly Replacement .....	4-156	ADJ 1.7	Interlock Flag Adjustment.....	4-189
REP 8.18	Holder Link Replacement.....	4-157	ADJ 1.8	Element Hook Position Adjustment.....	4-190
REP 8.19	Holder Lock Solenoid Replacement .....	4-158	ADJ 1.9	Holder Rotate Adjustment .....	4-192
<b>9. Frame</b>		<b>4-160</b>	ADJ 1.10	Element Tip Height Adjustment.....	4-193
REP 9.1	Interlock Switch Replacement, Top Cover.....	4-160	ADJ 1.11	Closer Cam Phase Adjustment.....	4-195
REP 9.2	Interlock Switch Replacement, Doors.....	4-161	ADJ 1.12	Caster Height Adjustment .....	4-196
REP 9.3	Lower Transport Assembly Latch Replacement.....	4-162	ADJ 1.13	Partial Close Adjustment.....	4-197
REP 9.4	Book Tray Latch Replacement .....	4-163	ADJ 1.14	Element Xfer Position Adjustment .....	4-197
REP 9.5	Element Feeder Drawer Latch Replacement.....	4-164	ADJ 1.15	Element Feeder Horizontal Position Adjustment .....	4-199
REP 9.6	Stepper Driver Boards Replacement, M3, M5, M15 & M21 4-165		ADJ 1.16	Element Feeder Angle Adjustment .....	4-201
REP 9.7	Vacuum Fan Replacement .....	4-167	ADJ 1.17	Element Feed Belt Tension Adjustment.....	4-203
REP 9.8	Vacuum Fan Gasket Replacement.....	4-168	ADJ 1.18	Knife Blade Adjustment.....	4-204
REP 9.9	Stacker Paper Detect Sensor S44 Replacement .....	4-169	ADJ 1.19	Top Cover Latch Adjustment.....	4-205
<b>10. Book Drawer</b>		<b>4-170</b>	ADJ 1.20	Cover Interlock Flag Adjustment.....	4-206
REP 10.1	Drawer Full Up Sensor Replacement S42.....	4-170	ADJ 1.21	Element Shield Adjustment.....	4-206
REP 10.2	Drawer Full Down Sensor Replacement S43 .....	4-171	ADJ 1.22	Closer Full Open Adjustment .....	4-208
REP 10.3	Book Drawer Full Sensor Replacement S45 .....	4-172	ADJ 1.23	Holder to Closer F Adjustment.....	4-209
REP 10.4	Book Drawer Drive Motor Replacement M19 .....	4-173	ADJ 1.24	F Size Max Capacity Closer Adjustment.....	4-210
REP 10.5	Book Tray Belt Removal Procedure .....	4-174			
<b>11. Electrical Components</b>		<b>4-175</b>			
REP 11.1	Main Control Board AC Replacement.....	4-175			
REP 11.2	Main Control Board B Replacement .....	4-176			
REP 11.3	24V Power Supply Replacement.....	4-177			

## REPLACEMENTS

### 1. External Covers

#### REP 1.1 Top Cover Replacement

##### PARTS LIST ON PL 5.28

Use this procedure to remove and install the Top Cover Assembly.

**Warning: Top Cover Assembly is very heavy. Use two people to remove and use caution when removing the Top Cover Assembly.**

#### Removal Procedure

### WARNING

**Do not perform repair activities with the power on or electrical power supplied to the machine. Some machine components contain dangerous electrical voltages that can result in electrical shock and possible serious injury. See Section 0, page vi for other languages.**

1. Switch power OFF to entire eWire.
2. Disconnect the Power Cord from eWire.
3. Raise the Upper Transport by releasing the latch.
4. Remove the M4 Screws (2) on the inside front of the Top Cover



5. Remove the M4 Screws (2) that secure the left side of the Top Cover.

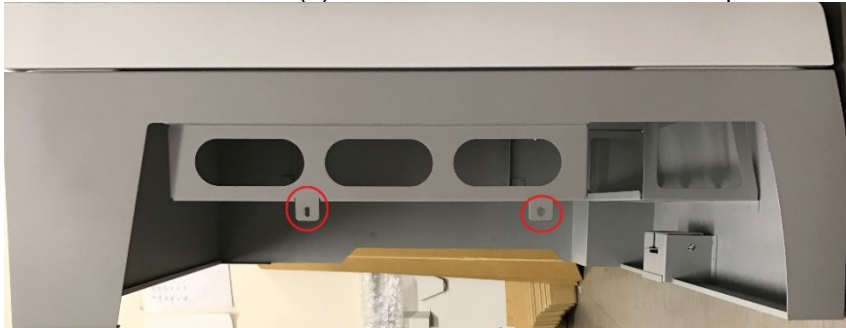

6. Remove the M4 Screws (2) that secure the right side of the Top Cover.



7. Slowly lower the Upper Transport down with cover still resting in place.
8. Carefully lift the entire top cover up and off the machine.

#### Installation Procedure

Use this procedure to install the top cover assembly

1. Switch power OFF to eWire.
2. Disconnect the Power Cord from eWire.
3. Lower the Upper Transport until the latch engages.
4. Lower the Top Cover Assembly onto the Upper Transport.
5. Lift up the Upper Transport by releasing the latch, while holding the Top Cover in place on the Transport Frame.
6. Line up the screw holes in the frame with the threaded holes in the Top Cover mounting brackets.
7. Install and tighten the Socket Head Screws (4) through the holes in the frame.
8. Connect the Power Cord.
9. Switch power ON the eWire.

## REP 1.2 Element Feeder Door Replacement

### PARTS LIST ON PL 5.28

Use this procedure to remove and install the Element Feeder Door Assembly

#### Removal Procedure

#### WARNING

**Do not perform repair activities with the power on or electrical power supplied to the machine. Some machine components contain dangerous electrical voltages that can result in electrical shock and possible serious injury. See Section 0, page vi for other languages.**

1. Switch power OFF to eWire.
2. Disconnect the Power Cord.
3. Do [REP 1.8 Front Cover Replacement](#) to remove the Front Cover.
4. Look at the inside of the book drawer bottom hinge, if it has a pull pin with a ring as shown below, continue to step 4, if not skip to step 7



5. Pull the pin out of the bottom hinge. You may need to lift the door slightly to free it.
6. Tilt the door and then lift it to free it from the top hinge pin and remove the Element Feeder Door
7. If the door did not have a pull pin, you must instead remove the top hinge to remove the door. Using a pencil or marker, draw an outline of the top hinge onto the frame to help place the hinge in the correct position when reinstalling.

8. Remove the M4 Screws (2) from the Upper Hinge Bracket while holding the door with your free hand to prevent movement. Remove the Upper Hinge Bracket while still supporting the weight of the door.



9. Lift the Door up off the pin on the lower hinge bracket.
10. Remove the Element Feeder Door.

#### Installation Procedure

If you did not have a pull pin, start on step 3.

1. If you have a pull pin hinge, place the Element Feeder Door in position so that the top hinge pin engages the top hole on the door.
2. Align the bottom hinge hole with the bottom door hole and press the pull pin through both holes. Skip to step 5
3. Place the Element Feeder Door in position so the pin on the lower hinge bracket fits into the hole in the bottom of the door.
4. Place the upper mounting bracket onto the pin at the top of the door and use M4 Screws (2) to attach the upper mounting bracket to the machine frame. Align the mounting bracket with the marks made before disassembly.
5. Do [ADJ 1.7](#) to adjust the Interlock Flag if necessary.
6. Plug in the Power Cord.
7. Switch power ON to the eWire



### REP 1.3 Door Bottom Hinge Bracket Replacement

Use this procedure to remove and install the Door Bottom Hinge Bracket.

#### Removal Procedure

1. Switch power OFF to eWire.
2. Disconnect the Power Cord.
3. Do REP 1.2 [Element Feeder Door Replacement](#) to remove the Element Feeder Door.
4. Do REP 1.6 [Side Cover Replacement](#) to remove the Side Cover.
5. Use a nut driver to remove the Screws (2) securing the Door Bottom Hinge Bracket to the machine.

#### Installation Procedure

1. Use a nut driver to tighten the Screws (2) mounting the new Door Bottom Hinge Bracket to the machine. Use the markings from the old Hinge Bracket as a guide to find the correct location.
2. Do REP 1.2 [Element Feeder Door Replacement](#) to install the Element Feeder Door.
3. Connect the Power Cord.
4. Power ON the eWire.

### REP 1.4 Door Top Hinge Bracket Replacement

Use this procedure to remove and install the Door Top Hinge Bracket.

#### Removal Procedure

1. Switch power OFF to eWire.
2. Disconnect the Power Cord.
3. Do REP 1.2 [Element Feeder Door Replacement](#) to remove the Element Feeder Door.
4. Use a nut driver to remove the Screws (2) mounting the Door Top Hinge Bracket to the machine.



#### Installation Procedure

1. Use a nut driver to tighten the Screws (2) mounting the new Door Top Hinge Bracket to the machine.
2. Do REP 1.2 [Element Feeder Door Replacement](#) to install the Element Feeder Door.
3. Connect the Power Cord.
4. Power ON the eWire.

## REP 1.5 Back Cover Replacement

### PARTS LIST ON PL 5.28

Use this procedure to remove and install the Back Cover.

#### Removal Procedure

#### **WARNING**

**Do not perform repair activities with the power on or electrical power supplied to the machine. Some machine components contain dangerous electrical voltages that can result in electrical shock and possible serious injury. See Section 0, page vi for other languages.**

1. Switch power OFF to eWire
2. Disconnect the Power Cord.
3. Hold the Back Cover in place so it doesn't fall as you remove the M4 Screws (2) from the Back Cover.

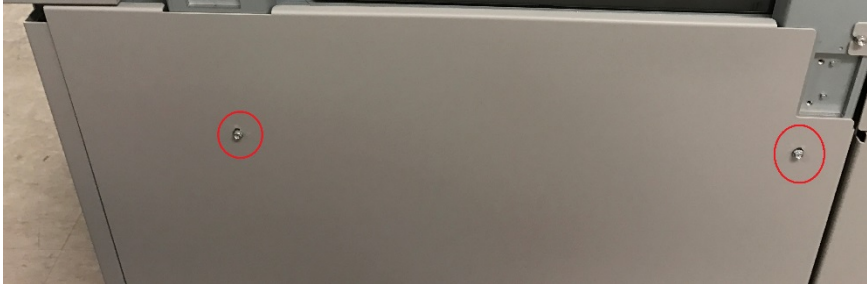

4. Carefully tilt the Back Cover back and then lift the Back Cover out of the tabs in the machine frame.

#### Installation Procedure

1. Lift the Back Cover assembly and align the tabs with the slots in the machine frame.
2. Carefully lower the cover tabs into the appropriate slots. Lean the cover forward until it is flush with the back of the frame.

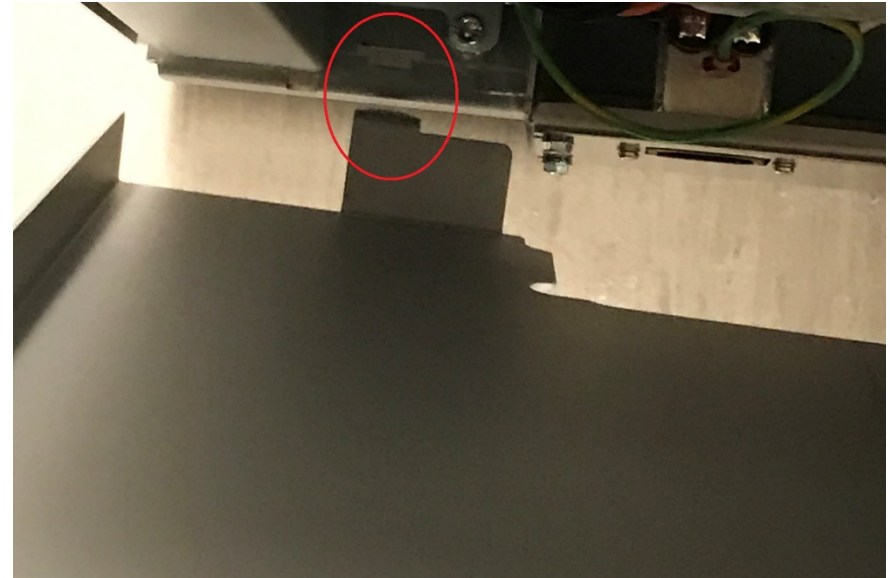

3. Tighten the M4 Screws (2) to secure the Back Cover.
4. Connect the Power Cord.
5. Switch power ON to eWire.

## REP 1.6 Side Cover Replacement

### PARTS LIST ON PL 5.28

Use this procedure to remove and install the Side Covers (2).

#### Removal Procedure

#### **WARNING**

**Do not perform repair activities with the power on or electrical power supplied to the machine. Some machine components contain dangerous electrical voltages that can result in electrical shock and possible serious injury. See Section 0, page vi for other languages.**

1. Switch power OFF to eWire.
2. Disconnect the Power Cord.
3. Hold the Side Cover in place so it doesn't fall as you remove the M4 Screws (2) from the Side Cover.
4. Carefully tilt the Side Cover back and then lift the Side Cover out of the tabs in the machine frame.

#### Installation Procedure

1. Lift the Side Cover assembly and align the tabs with the slots in the machine frame.
2. Carefully lower the cover tabs into the appropriate slots. Lean the cover forward until it is flush with the side of the frame.
3. Tighten the M4 Screws (2) to secure the Side Cover.
4. Connect the Power Cord.
5. Switch power ON to eWire.

## REP 1.7 Book Tray Door Replacement

### PARTS LIST ON PL 5.28

Use this procedure to remove and install the Book Tray Door.

#### Removal Procedure

#### **WARNING**

**Do not perform repair activities with the power on or electrical power supplied to the machine. Some machine components contain dangerous electrical voltages that can result in electrical shock and possible serious injury. See Section 0, page vi for other languages.**

1. Switch power OFF to eWire.
2. Disconnect the Power Cord.
3. Slide out the Book Tray by pulling on the handle.
4. Remove the M4 Screws (3) from the left and right side cover plate, while holding the cover secure with your free hand. Remove the cover plate and set it aside.



5. Remove the M4 Screws (2) from the lower half of the Book Tray Door.

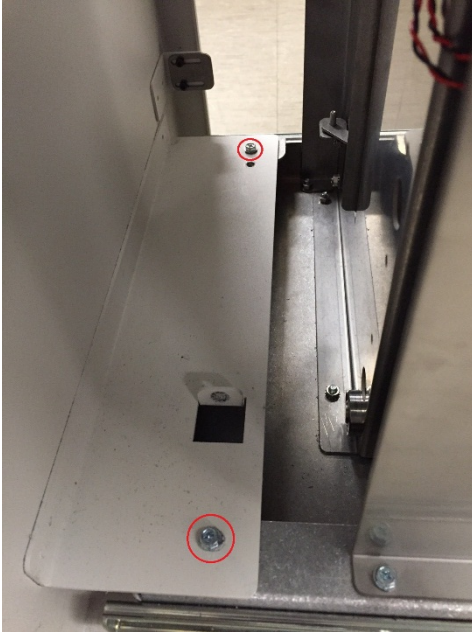

6. Lift the Door up off the mounting brackets and remove from the machine.

### Installation Procedure

1. Place the Book Tray Door in position so the M4 holes on the upper and lower mounting holes are aligned with the corresponding screw holes on the Book Drawer. Tighten the M4 Screws (4) to secure the Book Tray Door.
2. Tighten the M4 Screws (3) to secure the left side cover plate.
3. Tighten the M4 Screws (3) to secure the right side cover plate.
4. Do ADJ 1.7 to adjust the Interlock Flag.
5. Plug in the Power Cord.
6. Switch power ON to the eWire

## REP 1.8 Front Cover Replacement

### PARTS LIST ON PL 5.28

Use this procedure to remove and install the Front Cover.

#### Removal Procedure

#### **WARNING**

**Do not perform repair activities with the power on or electrical power supplied to the machine. Some machine components contain dangerous electrical voltages that can result in electrical shock and possible serious injury. See Section 0, page vi for other languages.**

1. Switch power OFF to eWire.
2. Disconnect the Power Cord.
3. Raise the Upper Transport Assembly by releasing the latch on the Top Cover.
4. Loosen, but do not remove completely the M4 Screw (1) on the side of the Front Cover.



5. Remove the M4 Screws (2) from the top of the Front Cover.



6. Slide the Front Cover off the eWire.

#### Installation Procedure

1. Tighten the M4 Screws (4) to install the Front Cover to the frame. Press the Front Cover securely against the frame while tightening to ensure proper alignment. Refer to Removal Procedure for details.
2. Lower the Upper Transport.
3. Plug in the Power Cord.
4. Switch power ON to the eWire

## REP 1.9 LCD Display Replacement

### PARTS LIST ON PL 5.1

Use this procedure to remove and install the LCD Display.

#### Removal Procedure

#### **WARNING**

**Do not perform repair activities with the power on or electrical power supplied to the machine. Some machine components contain dangerous electrical voltages that can result in electrical shock and possible serious injury. See Section 0, page vi for other languages.**

1. Switch power OFF to eWire.
2. Disconnect the Power Cord.
3. Raise the Upper Transport Assembly.
4. Remove the LCD back panel by removing the M4 Screws (4).
5. Disconnect the Cables from the LCD Display.
6. Remove the M3 Screws (3) holding the LCD Display to the Top Cover. Note the location of the black ground strap that is attached to one of the screws.

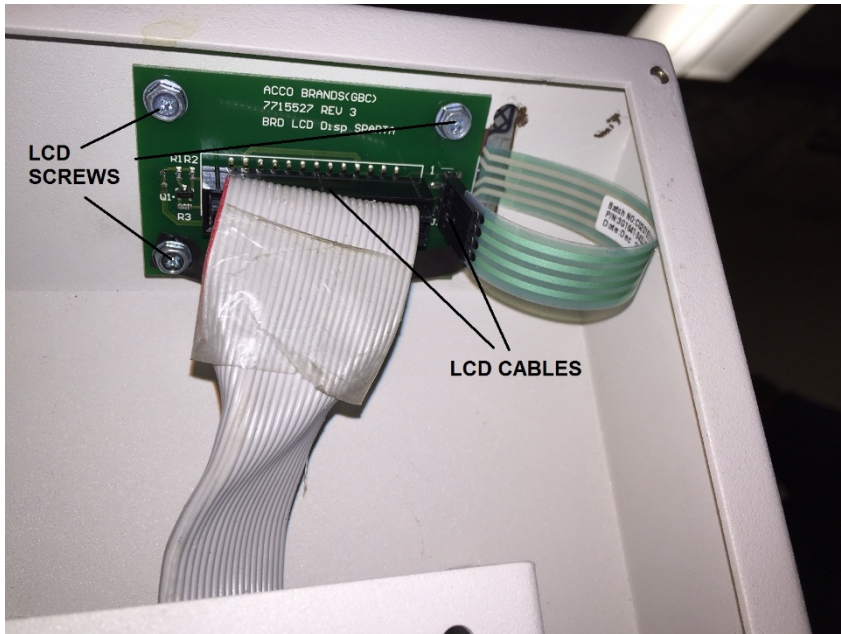

7. Remove the LCD Display.

#### Installation Procedure

1. Place the new LCD Display Panel in position.
2. Tighten the Screws (3) holding the LCD Display to the LCD Panel. Attach the ground strap using one of the 3 screws.
3. Connect the Cables (2) to the LCD Display Panel.
4. Lower the Upper Transport assembly.
5. Connect the Power Cord.
6. Power ON the eWire.

## REP 1.10 LCD Membrane Switch Panel Replacement

### PARTS LIST ON PL 5.1

Use this procedure to remove and install the LCD Membrane Switch Panel.

#### Removal Procedure

#### **WARNING**

**Do not perform repair activities with the power on or electrical power supplied to the machine. Some machine components contain dangerous electrical voltages that can result in electrical shock and possible serious injury. See Section 0, page vi for other languages.**

1. Switch power OFF to eWire
2. Disconnect the Power Cord.
3. Raise the Upper Transport.
4. Disconnect the LCD Membrane Switch Connector from the LCD 5.  
Remove the M3 Screw that secures the ground strap.
6. Using a straight edge, peel off the old LCD Membrane. Carefully remove any adhesive residue from the panel.

#### Installation Procedure

1. Insert the LCD cables through the slot on the panel surface
2. Install the new Membrane to the panel surface of the LCD Panel using the adhesive. Carefully align the new Membrane to the LCD display opening. You may be able to use the outline of the old LCD Membrane as a guide.
3. Connect the LCD Membrane Switch Connector to the LCD Display.
4. Secure the ground strap by tightening the M3 mounting Screw.
5. Connect the Power Cord.
6. Power ON the eWire

## REP 1.11 Caster Replacement

### PARTS LIST ON PL 5.1

Use this procedure to replace the Caster Assembly.

#### Removal Procedure

#### WARNING

**Do not perform repair activities with the power on or electrical power supplied to the machine. Some machine components contain dangerous electrical voltages that can result in electrical shock and possible serious injury. See Section 0, page vi for other languages.**

1. Switch power OFF to eWire
2. Disconnect the Power Cord.
3. Carefully lift the corner of the eWire nearest the Caster. Support the eWire so that the machine is secured when Caster is removed.
4. Do REP 1.6 [Side Cover Replacement](#) to remove the Side Cover nearest the Caster.
5. Loosen the Jam Nuts

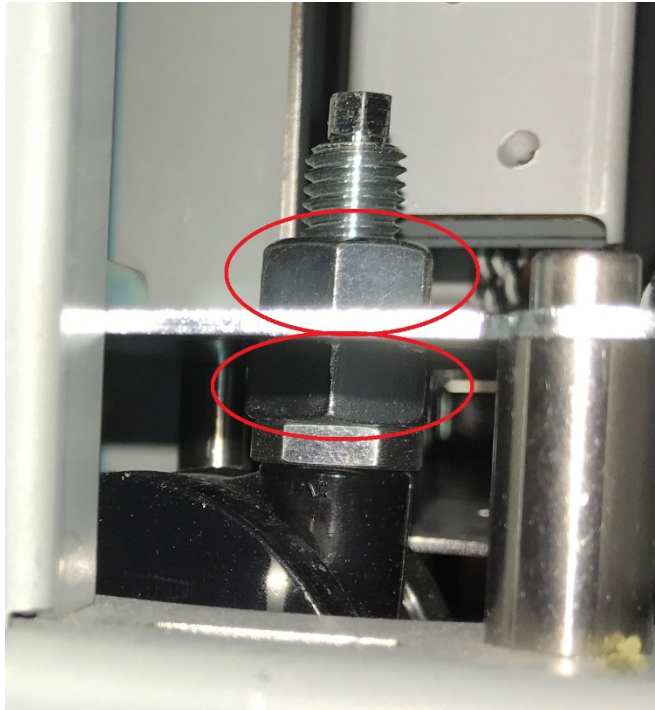

6. Remove the M5 Mounting Screws (4) to remove the Caster Plate. The Caster Assembly can be lifted up through the Frame.

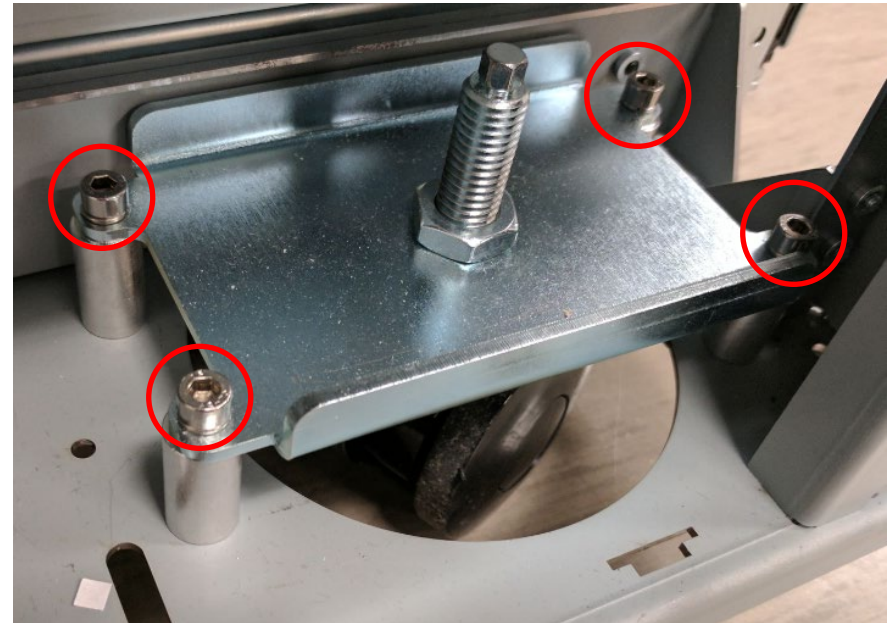

#### Installation Procedure

1. Place the new Caster in position and screw it in.
2. Tighten the Jam Nut.
3. Lower the eWire
4. Do REP 1.6 [Side Cover Replacement](#) to install the Side Cover.
5. Connect the Power Cord.
6. Power ON the eWire.



## 2. Paper Transport

### REP 2.1 Drive Roller Replacement – Paper Path

#### PARTS LIST ON PL 5.5

Use this procedure to remove and install the Drive Roller Assembly (Part # 7715093) used in Nips N1 – N3, N6 - N7, and N10 - N15.

#### Removal Procedure

1. Switch power OFF to eWire.
2. Do [REP 1.1 Top Cover Replacement](#) to remove the Top Cover.
3. Raise the Upper Bypass Panel.
4. Locate the appropriate Drive Roller.

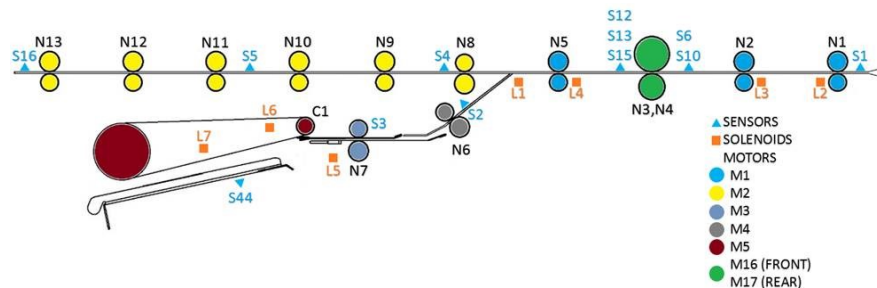

5. Do [REP 2.8](#) (Nips N1 N2 and N5) or [REP 2.9](#) (Nips N8 – N13) to remove the Belt from the appropriate Drive Roller Shaft.
6. Do [REP 2.7 Belt Drive Timing Pulley Replacement](#) to remove the Pulley from the appropriate Drive Roller Shaft.
7. Remove the E-Ring and the Washer from the end of the Drive Roller Shaft at the front of the machine.

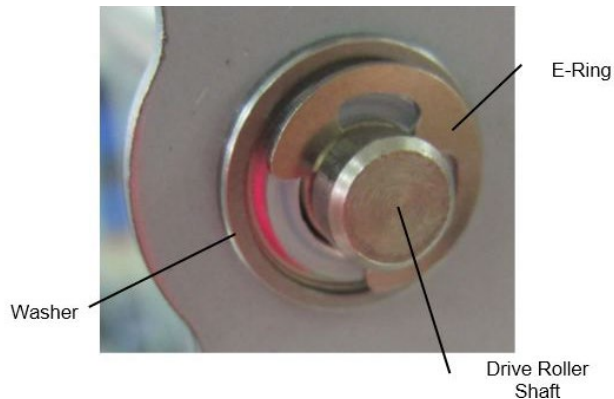

8. Remove the Bearing from the front of the machine.

9. Remove the Bearing from the rear of the machine.
10. Remove the Drive Roller.

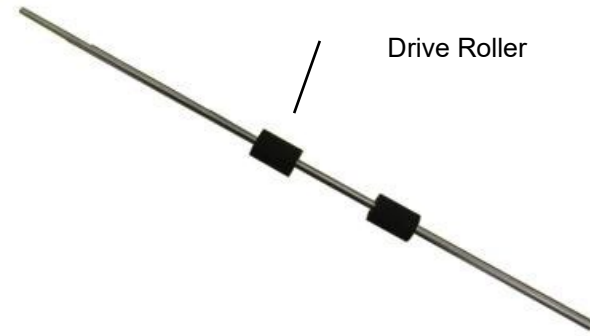

#### Installation Procedure

1. Place the Drive Roller in position
2. Install the Bearing at the front of the machine.
3. Install the Bearing at the rear of the machine.
4. Replace the Washer and E-Ring at the front of the machine.
5. Do [REP 2.7 Belt Drive Timing Pulley Replacement](#) to install Drive Roller Pulley.
6. Do [REP 2.8](#) (Nips N1 – N3) or [REP 2.9](#) (Nips N10 – N15) to install the Timing Belt. Do this after all Drive Rollers you plan to replace have been replaced.
7. Do [REP 1.1 Top Cover Replacement](#) to install the Top Cover.
8. Connect the Power Cord.
9. Power ON the eWire.

## REP 2.2 Drive Roller Replacement – Steering Module

### PARTS LIST ON PL 5.5

Use this procedure to remove and install the Steering Module Drive Roller Assembly, Nips **N3** and **N4**.

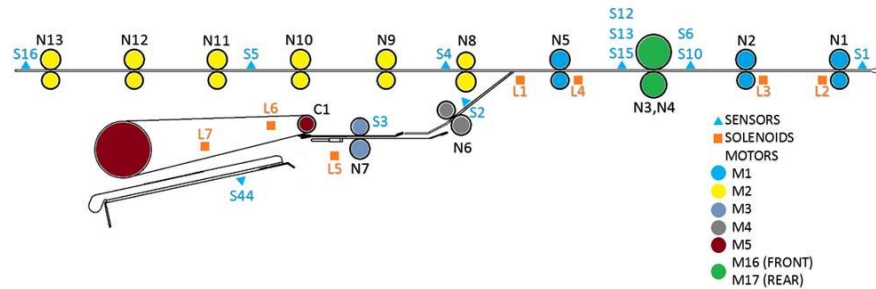

### Removal Procedure

1. Switch power OFF to eWire.
2. Disconnect the Power Cord.
3. Raise the Upper Bypass Panel
4. Do REP 2.21 [Steering Module Replacement](#) to remove the Steering Module from the Machine.
5. Remove the Panel Assembly by removing the M3 Nuts (4) on the underside of the Panel Assembly, located just above the rollers.
6. Remove the Drive Panel assembly by removing the M3 Nuts (4). Set the Idler and Drive Panel assemblies aside.
7. Remove the E-Ring, Compression Spring, and Washer from the Steering Drive Roller Shaft.

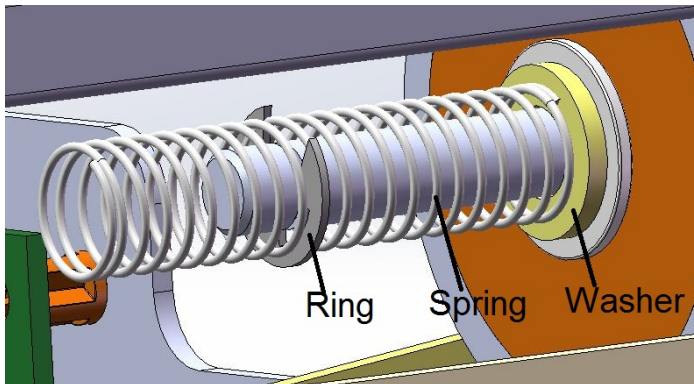

8. Loosen the M3 Screws on the Steering Module Stepper Motor to relieve tension on the Drive Belt.
9. Slide the Steering Drive Roller Sub-Assembly (roller, pulley and bearings) off the Drive Shaft.

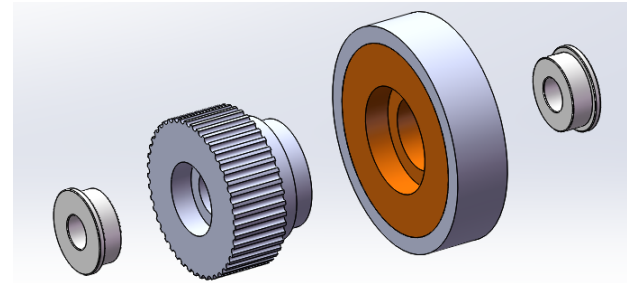

10. Repeat the process for the opposite side.

### Installation Procedure

1. Install the Bearing and the Steering Drive Pulley onto the Steering Drive Shaft. Ensure that an M6 washer is placed between the bearing and the motor bracket. Refer to PL 5.5.
2. Install the Steering Drive Roller assembly and bearing onto the shaft.
3. Install the M6 Washer, Compression Spring, and E-Ring onto the shaft.
4. Repeat the procedure for the opposite side.
5. Re-attach the drive panel assembly by securing the M3 nuts (4).
6. Do REP 2.21 [Steering Module Replacement](#) to replace the Steering Module.
7. Connect the Power Cord.
8. Power ON the eWire.

## REP 2.3 Drive Roller Bearing Replacement

### PARTS LIST ON PL 5.5

Do the following to replace the Drive Roller Bearings

#### Removal Procedure

1. Switch power OFF to eWire.
2. Disconnect the Power Cord.
3. Do REP 1.1 [Top Cover Replacement](#) to remove the Top Cover.
4. Locate the Flange Ball Bearing.

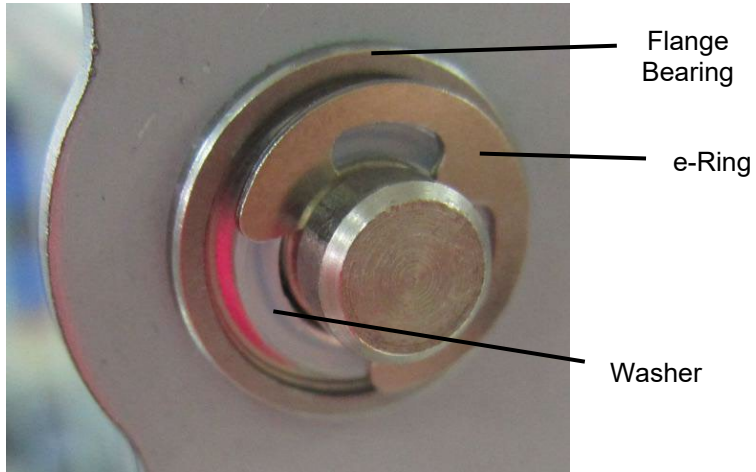

5. For Bearings on front of machine, remove the E-Ring and Washer.
6. For Bearings on rear of machine, do [REP 2.8](#) (Nips N1 – N3) or [REP 2.9](#) (Nips N10 – N15) to remove the Belt from the appropriate Drive Roller Shaft.
7. For Bearings on rear of machine, do REP 2.7 [Belt Drive Timing Pulley Replacement](#) to remove the Pulley from the appropriate Drive Roller Shaft.
8. Remove the Flange Ball Bearing.

#### Installation Procedure

1. Place the new Flange Ball Bearing in position.
2. For Bearings on front of machine, re-install the washer and E-Ring.
3. For Bearings on rear of machine, reverse steps in Removal Procedure to re-install the Belt and Pulley.
4. If the Timing Belt was replaced, double check the belt tension. Adjust tension using the Belt Tensioner if needed. Refer to PL 5.4.
5. Connect the Power Cord.
6. Power ON the eWire.

## REP 2.4 Idler Roller Replacement, Paper Path

### PARTS LIST ON PL 5.5

Use this procedure to remove and install the Idler Rollers on the following Nips: **N1 - N2, and N5-17**

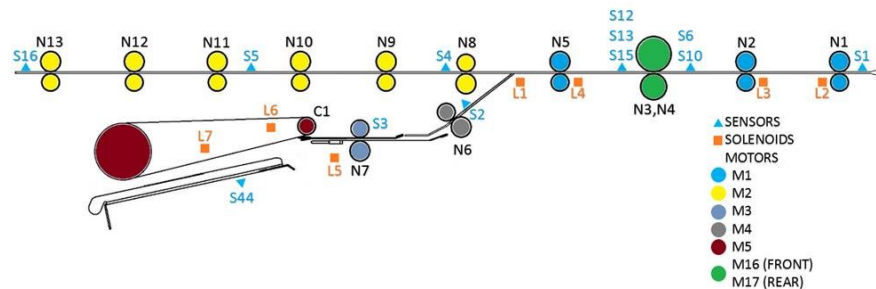

### Removal Procedure

#### WARNING

**Do not perform repair activities with the power on or electrical power supplied to the machine. Some machine components contain dangerous electrical voltages that can result in electrical shock and possible serious injury. See Section 0, page vi for other languages.**

1. Switch power OFF to eWire.
2. Disconnect the Power Cord.
3. Do REP 1.1 [Top Cover Replacement](#) to remove the Top Cover.
4. For Rollers on Nip N7 only, raise the Lower Bypass Panel. The idler roller is located on the surface of the curved plate under the panel.

5. Lift the Extension Spring (2) up off the Bearing Housing (2) at each end of the Idler Roller Shaft. Unhook the ends of the extension spring from the Bushing Forks.

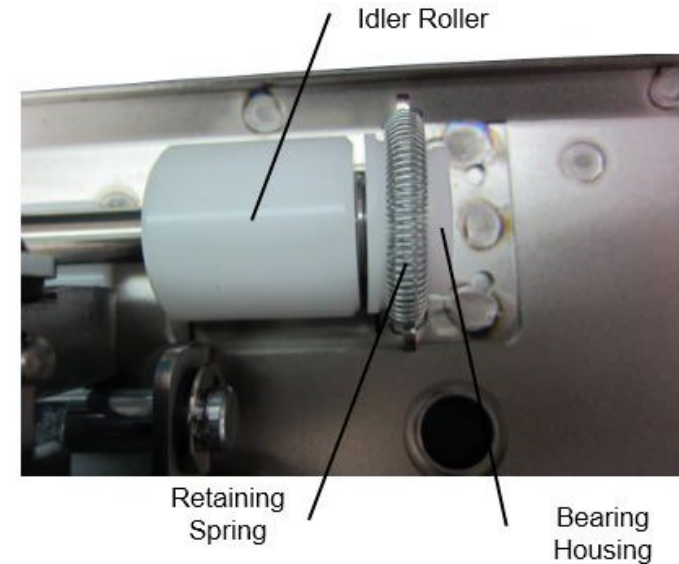

6. Remove the Idler Roller with the Bearing Housings (2) from the Bushing Forks.

### Installation Procedure

1. Place the new Idler Roller with Bearing Housings into the Bushing Forks.
2. Make sure the flat surface of the bushing aligns in the fork.
3. Rollers are non-directional so it does not matter which end goes in each fork.
4. After the assembly is in place, gently pull the assembly outward and release to ensure it moves freely in the fork.
5. Place the Extension Spring (2) over the Bearing Housings (2).
6. Place the hooks on the ends of the Extension Springs (2) on the notches at the top of the Bushing Forks (2).
7. Do REP 1.1 [Top Cover Replacement](#) to install the Top Cover.
8. Connect the Power Cord.
9. Power ON the eWire.

## REP 2.5 Idler Roller Replacement, Steering Module

### PARTS LIST ON PL 5.5

Use this procedure to remove and install the Idler Rollers on the following Nips: **N3 and N4**

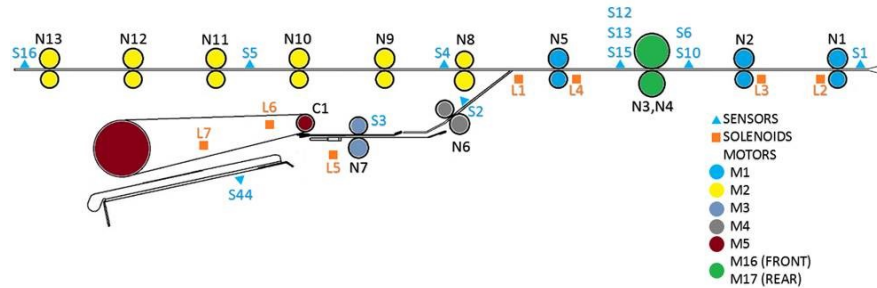

### Removal Procedure

1. Switch power OFF to eWire.
2. Disconnect the Power Cord.
3. Raise the Upper Bypass Panel
4. Remove the Extension Spring (2) by unhooking the spring ends from the hooks on the mounting bracket.



5. Slide the Idler Roller Assembly out of the Steering Module by lifting the bearings out of the bearing mount brackets

### Installation Procedure

1. Place the new Steering Idler Roller Assembly into the Bearing Mount Brackets on the Steering Module.
2. Make sure the flat faces of the Bearings align with the slot on the Bearing Mount Brackets.
3. Rollers are non-directional so it does not matter which end goes in which bracket.
4. After the assembly is in place, gently pull the assembly outward and release to ensure it moves freely in the housing.
5. Place the Extension Spring (2) over the Bearing hub (2).
6. Place the hooks on the ends of the Extension Springs (2) into the mounting holes on the Bearing Mount Brackets.
7. Lower the Upper Bypass Panel
8. Connect the Power Cord.
9. Power ON the eWire.

## REP 2.6 Belt Drive Idler Pulley Replacement

### PARTS LIST ON PL 5.4

Use this procedure to remove and install the Belt Drive Idler Pulleys (7715383) on the rear of the Upper Transport.

#### Removal Procedure

#### **WARNING**

**Do not perform repair activities with the power on or electrical power supplied to the machine. Some machine components contain dangerous electrical voltages that can result in electrical shock and possible serious injury. See Section 0, page vi for other languages.**

1. Switch power OFF to eWire.
2. Disconnect the Power Cord.
3. Do REP 1.1 [Top Cover Replacement](#) to remove the Top Cover.
4. Do REP 2.8 [Bypass Timing Belt #1 Replacement](#) or [REP 2.9](#) to remove the Timing Belt.
5. Remove the E-Ring and the Spacer.
6. Slide the old Idler Pulley from the Standoff.



#### Installation Procedure

1. Place the new Idler Pulley onto the standoff.
2. Install the Washer and the E-Clip.
3. Do REPS 2.8 or 2.9 [Bypass Timing Belt #1 Replacement & Bypass Timing Belt #2 Replacement](#) to replace the Timing Belt.
4. Do REP 1.1 [Top Cover Replacement](#) to replace the Top Cover.
5. Connect the Power Cord.
6. Power ON the eWire.

## REP 2.7 Belt Drive Timing Pulley Replacement

### PARTS LIST ON PL 5.4

Use this procedure to remove and install the Timing Pulley.

#### Removal Procedure

#### **WARNING**

**Do not perform repair activities with the power on or electrical power supplied to the machine. Some machine components contain dangerous electrical voltages that can result in electrical shock and possible serious injury. See Section 0, page vi for other languages.**

1. Switch power OFF to eWire.
2. Disconnect the Power Cord.
3. Do REP 1.1 [Top Cover Replacement](#) to remove the Top Cover.
4. Do [REP 2.8](#) or [REP 2.9](#) to remove the Timing Belt.
5. Remove the retaining ring from the roller shaft.



6. Remove the Timing Pulley by sliding it off the shaft. Be careful not to lose the spring washer or the spacer.

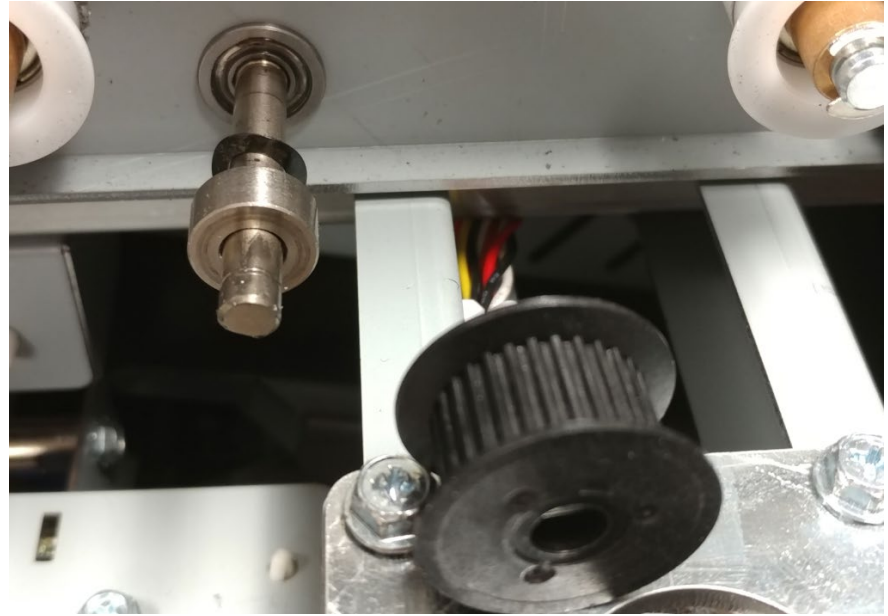

#### Installation Procedure

1. Place the Timing Pulley in position on the Shaft and install the retaining ring.
2. Do REPs 2.8 & 2.9 [Bypass Timing Belt #1 Replacement & Bypass Timing Belt #2 Replacement](#) to install the appropriate Timing Belts.
3. Do REP 1.1 [Top Cover Replacement](#) to install the Top Cover.
4. Connect the Power Cord.
5. Power ON the eWire.

## REP 2.8 Bypass Timing Belt #1 Replacement

There are two timing belts used at the rear of the eWire Upper Bypass Assembly. The procedure below can be used for the upstream (paper entry side) Belt.

Type of Belt	Location	Motor
Belt, 380, 2MM GT2	Upstream	M1
Belt, 534, 2MM GT2	Downstream	M2

### Removal Procedure

1. Turn power OFF to the eWire.
2. Remove the Power Cord.
3. Do REP 1.1 [Top Cover Replacement](#) to remove the Top Cover.
4. Do REP 2.18 [Solenoid Replacement, Diverter Solenoid \(L1\)](#) to remove the Diverter Solenoid
5. Remove the Cable Transport Bracket by removing the M4 Screws (3).

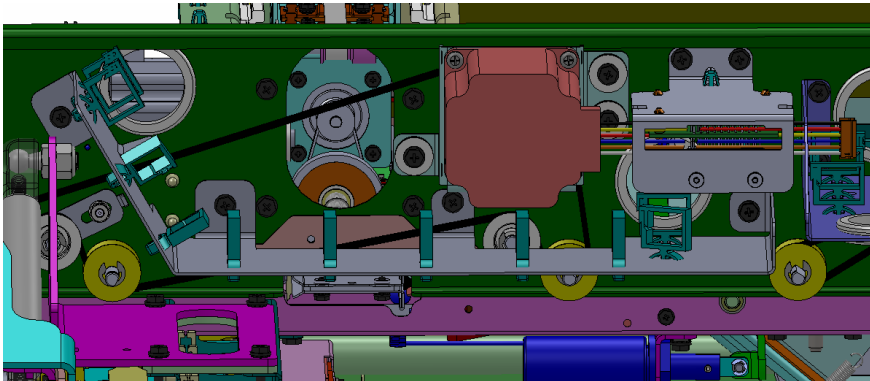

6. Relieve tension on the Belt by loosening the M4 screws (2) on the Belt Tensioner.

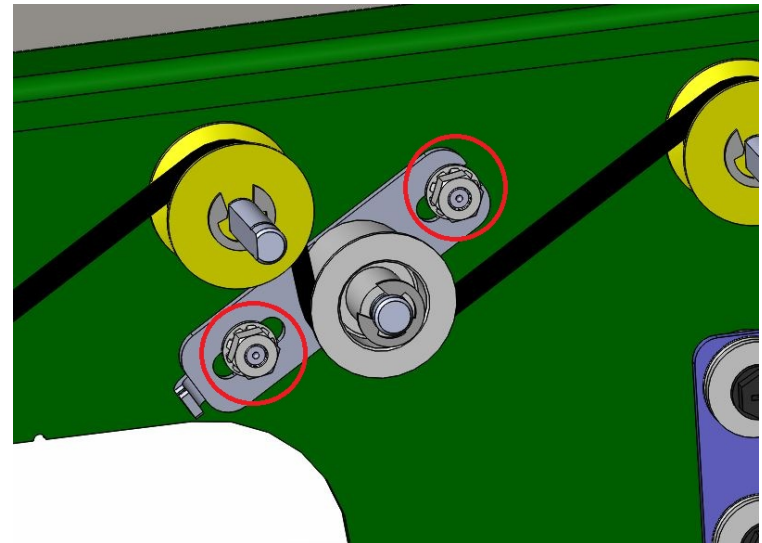

7. Disconnect the cables running through the cable control bracket by disconnecting it at the header.
8. Carefully remove the Belt by lifting it off of the Idler Pulleys and Drive Pulleys and remove the old belt.

### Installation Procedure

1. Carefully place the new Belt into position around the Driver and Idler Pulleys.
2. Adjust the Belt tension.
3. Replace the Wire Control Bracket.
4. Replace all Cables moved during the Belt Removal process.
5. Do REP 2.18 [Solenoid Replacement, Diverter Solenoid \(L1\)](#) to Install the Diverter Solenoid.
6. Do REP 1.1 [Top Cover Replacement](#) to replace the Top Cover.
7. Connect the Power Cord.
8. Power ON the eWire.



## REP 2.9 Bypass Timing Belt #2 Replacement

There are two timing belts used at the rear of the eWire Upper Bypass Assembly. The procedure below can be used for the downstream (paper exit side) Belt.

Type of Belt	Location	Motor
Belt, 380, 2MM GT2	Upstream	M1
Belt, 534, 2MM GT2	Downstream	M2

### Removal Procedure

1. Turn power OFF to the eWire.
2. Remove the Power Cord.
3. Do REP 1.1 [Top Cover Replacement](#) to remove the Top Cover.
4. Do REP 2.18 [Solenoid Replacement, Diverter Solenoid \(L1\)](#) to remove the Diverter Solenoid
5. Disconnect the wires from the M2 Bypass Stepper Motor.
6. Relieve tension on the Belt by loosening the M4 screws (2) on the Belt Tensioner.

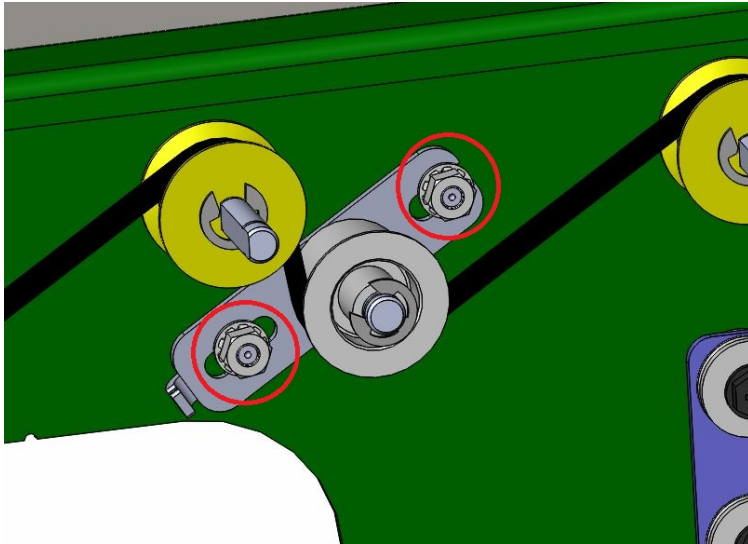

7. Carefully remove the Belt by lifting it off of the Idler Pulleys and Drive Pulleys and remove the old Belt.

### Installation Procedure

1. Place the new Belt into position around the Driver and Idler Pulleys.
2. Adjust the Belt tension. The belt should be taut but still be able to flex approximately 1" when you press on it.
3. Replace the M2 Stepper Motor cable.
4. Do REP 1.1 [Top Cover Replacement](#) to replace the Top Cover.
5. Connect the Power Cord.
6. Power ON the eWire.

## REP 2.10 Stepper and Mount Assembly Replacement

### PARTS LIST ON PL 5.3

Use this procedure to remove and install the Bypass 1 (M1) and Bypass 2 (M2) stepper motors.

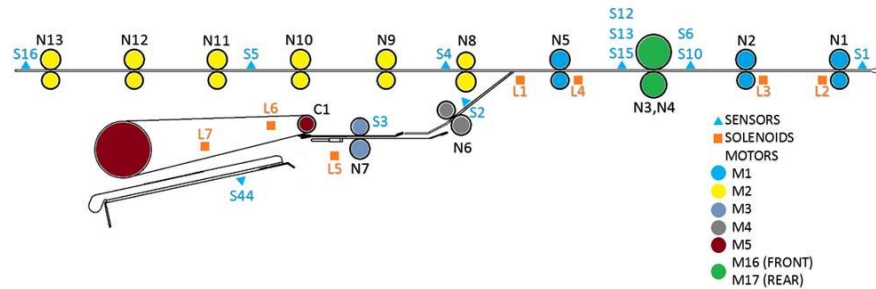

### Removal Procedure

#### WARNING

**Do not perform repair activities with the power on or electrical power supplied to the machine. Some machine components contain dangerous electrical voltages that can result in electrical shock and possible serious injury. See Section 0, page vi for other languages.**

1. Switch power OFF to eWire.
2. Disconnect the Power Cord.
3. Do REP 1.1 [Top Cover Replacement](#) to remove the Top Cover.
4. Locate the affected Motor.
5. Disconnect the Motor Connector from the corresponding Motor Driver.
6. Remove tension from the Belt by loosening the Belt Tensioner.

7. Remove the Screws and Washers (4) and remove the Stepper Mount Bracket from the Frame.

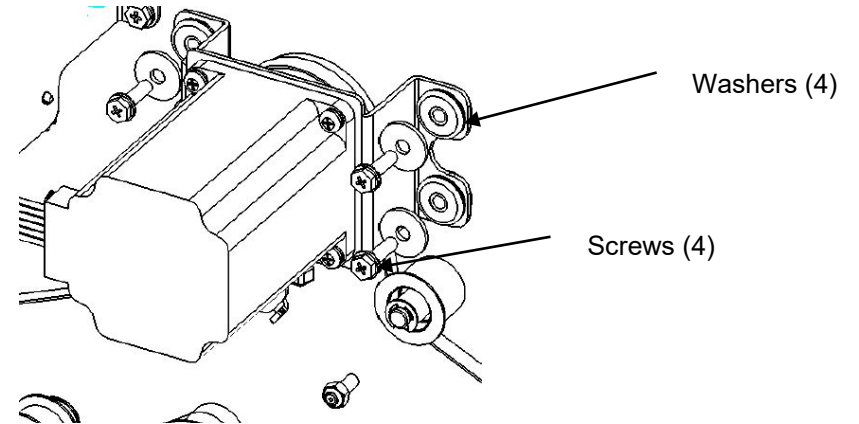

8. Remove the Motor Timing Pulley from the Motor shaft by pulling it off of the shaft.
9. Remove the Stepper Motor from the Motor Bracket by removing the M4 screws (4)

### Installation Procedure

1. Install the Stepper Motor Pulley onto the Motor shaft
2. Install the Motor onto the Motor Bracket by tightening the M4 Screws (4). Note the directional orientation of the motor cable.
3. Place the Motor Bracket Assembly in position and tighten the Screws (4).
4. Connect the Motor Connector.
5. Adjust the Belt tension. The belt should be taut but still be able to flex approximately 1" when you press on it.
6. Do REP 1.1 [Top Cover Replacement](#) to install the Top Cover.
7. Connect the Power Cord.
8. Power ON the eWire.

## REP 2.11 Stepper Motor Pulley Replacement

### PARTS LIST ON PL 5.4

Use this procedure to remove and install the Stepper Motor Pulley (7715201). The Stepper Motor Pulley is used with Stepper Motors M1 and M2.

#### Removal Procedure

#### **WARNING**

**Do not perform repair activities with the power on or electrical power supplied to the machine. Some machine components contain dangerous electrical voltages that can result in electrical shock and possible serious injury. See Section 0, page vi for other languages.**

1. Switch power OFF to eWire.
2. Disconnect the Power Cord.
3. Do REP 1.1 [Top Cover Replacement](#) to remove the Top Cover.
4. Do REP 2.17 [Motor Driver \(Stepper Driver\) Replacement, M1 and M2](#) to remove the appropriate Stepper Motor and Mount.
5. Slide the Stepper Motor Pulley off the Motor shaft.

#### Installation Procedure

1. Press the new Stepper Motor Pulley onto the shaft of the Stepper Motor.
2. Do REP 2.17 [Motor Driver \(Stepper Driver\) Replacement, M1 and M2](#) to replace the Stepper Motor and Mount.
3. Do REP 1.1 [Top Cover Replacement](#) to install the Top Cover.
4. Connect the Power Cord.
5. Power ON the eWire.

## REP 2.12 Timing Belt Tensioner Replacement

### PARTS LIST ON PL 5.4

Use this procedure to remove and install the Timing Belt Tensioner Assembly.

#### Removal Procedure

#### **WARNING**

**Do not perform repair activities with the power on or electrical power supplied to the machine. Some machine components contain dangerous electrical voltages that can result in electrical shock and possible serious injury. See Section 0, page vi for other languages.**

6. Switch power OFF to eWire.
7. Disconnect the Power Cord.
8. Do REP 1.1 [Top Cover Replacement](#) to remove the Top Cover.
9. Remove the M4 Nuts on the Tensioner and carefully remove the Tensioner Assembly from the Bypass Panel.



Tensioner

#### Installation Procedure

1. Place the new Tensioner Assembly onto the M4 studs and loosely attach the M4 nuts. Ensure the Idler Pulley on the Tensioner Assembly is lightly pressing the Timing Belt.
2. Adjust the Belt tension. The belt should be taut but still be able to flex approximately 1" when you press on it.
3. Tighten the Tensioner mounting bolts when you have achieved correct Belt tension.
4. Do REP 1.1 [Top Cover Replacement](#) to install the Top Cover.
5. Connect the Power Cord.
6. Power ON the eWire.

## REP 2.13 Bypass Sensor Replacement, S1, S4, S5 & S16

### PARTS LIST ON 5.2

Use this procedure to remove and install the Bypass Sensors (S1, S4, S5, and S16)

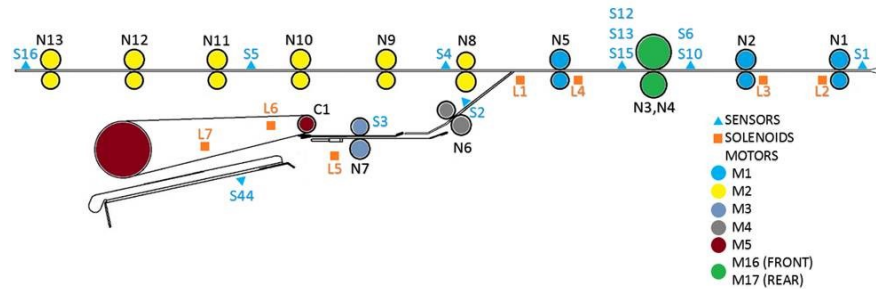

### Removal Procedure

#### WARNING

**Do not perform repair activities with the power on or electrical power supplied to the machine. Some machine components contain dangerous electrical voltages that can result in electrical shock and possible serious injury. See Section 0, page vi for other languages.**

1. Switch power OFF to eWire.
2. Disconnect the Power Cord.
3. Do REP 1.1 [Top Cover Replacement](#) to remove the Top Cover.
4. Locate the appropriate sensor on the Bypass Panel.
5. Disconnect the Sensor Connector at the Sensor.

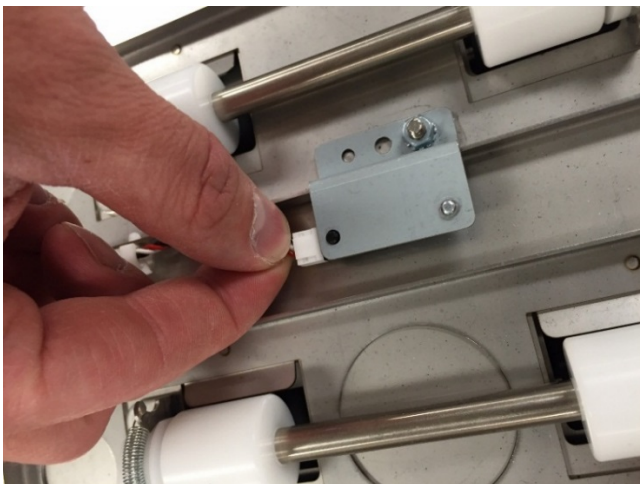

6. Remove the Sensor Bracket by removing the M4 Nut.

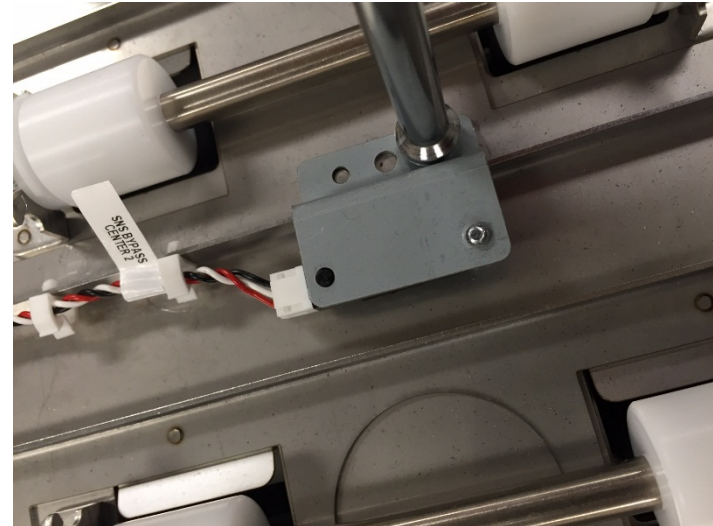

7. Remove the old sensor from the Sensor Bracket by removing the M3 Screw.

### Installation Procedure

1. Place the Sensor in position, then install and tighten the Screw.
2. Connect the Sensor Connector.
3. Do REP 1.1 [Top Cover Replacement](#) to install the Top Cover.
4. Connect the Power Cord.
5. Power ON the eWire.

## REP 2.14 Skew Measurement Sensor Replacement, S6-S10

### PARTS LIST ON PL 3.7

Use the following procedures to remove and install the Skew Sensors, S6-S10. The Skew Sensors are located on the Skew Sensor PCB (7715692).

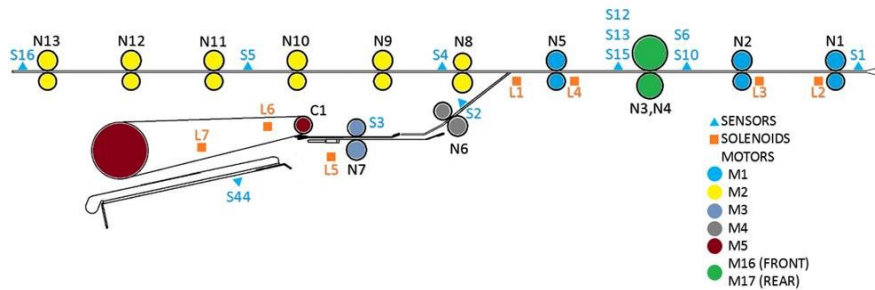

### Removal Procedure

#### WARNING

Do not perform repair activities with the power on or electrical power supplied to the machine. Some machine components contain dangerous electrical voltages that can result in electrical shock and possible serious injury. See Section 0, page vi for other languages.

1. Switch power OFF to eWire.
2. Disconnect the Power Cord.
3. Do REP 1.1 [Top Cover Replacement](#) to remove the Top Cover.
4. Locate the Skew Sensor PCB on the Steering Module
5. Disconnect the Connector from the PCB.

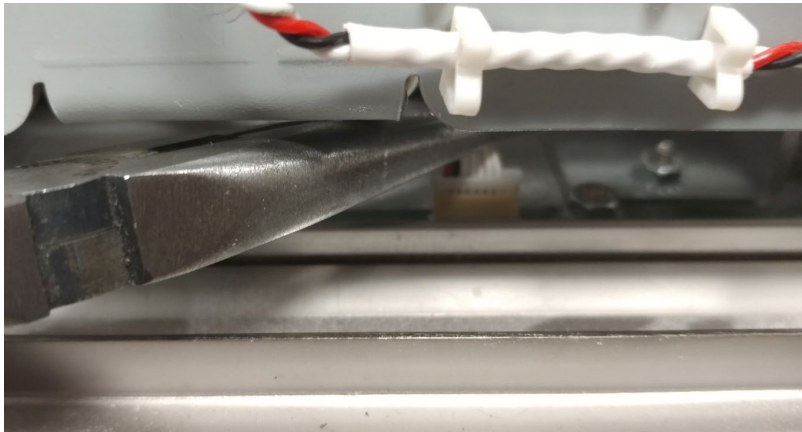

6. Release the Skew Sensor PCB by removing the M3 Nuts (4)

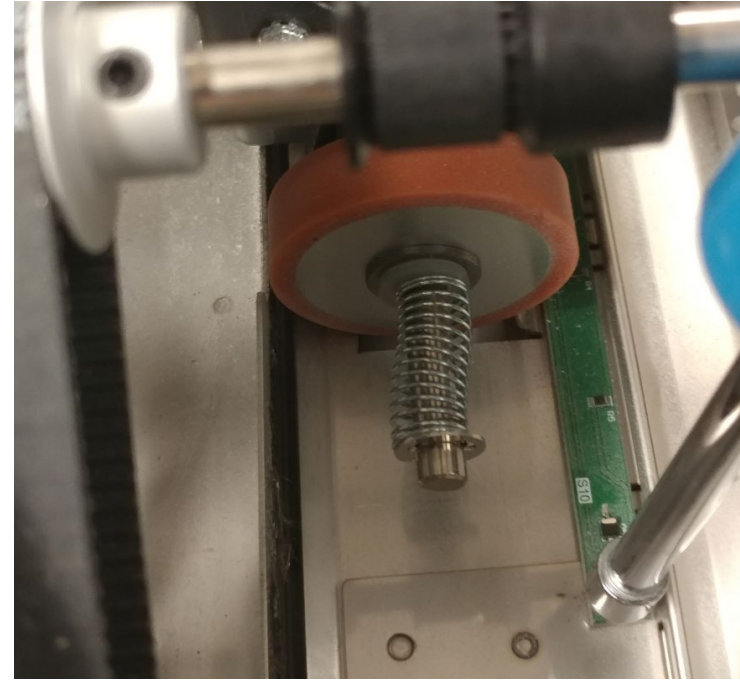

7. Remove the old Skew Sensor PCB from the Upper Bypass.

### Installation Procedure

1. Place the new Skew Sensor PCB onto the Upper Bypass by aligning it with the M3 studs. Ensure that S6 is oriented at the rear of the machine and S10 is oriented at the front of the machine.
2. Tighten the M3 Nuts to secure the PCB.
3. Connect the Sensor Cable to the PCB.
4. Do REP 1.1 [Top Cover Replacement](#) to install the Top Cover.
5. Connect the Power Cord.
6. Power ON the eWire.

## REP 2.15 Alignment Sensor Replacement, S12, S13 & S15

### PARTS LIST ON PL 5.2

Use the following procedures to remove and install the Alignment Sensors (S12, S13, and S15). The Alignment Sensors are located on the Alignment Sensor PCB (7715694).

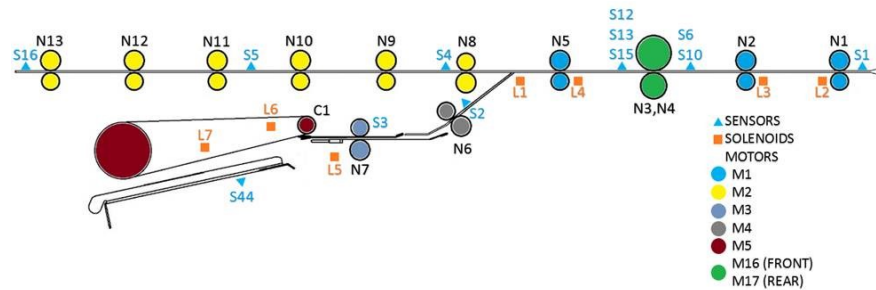

### Removal Procedure

#### WARNING

**Do not perform repair activities with the power on or electrical power supplied to the machine. Some machine components contain dangerous electrical voltages that can result in electrical shock and possible serious injury. See Section 0, page vi for other languages.**

1. Switch power OFF to eWire.
2. Disconnect the Power Cord.
3. Do REP 1.1 [Top Cover Replacement](#) to remove the Top Cover.
4. Locate the Alignment Sensor PCB on the Bypass Panel.

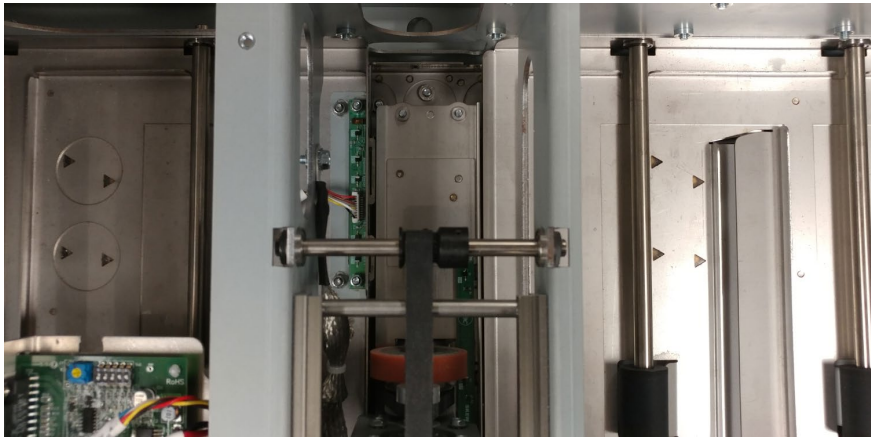

5. Disconnect the Cable Connector from the PCB.
6. Release the Alignment Sensor PCB by removing the M3 Nuts (2)

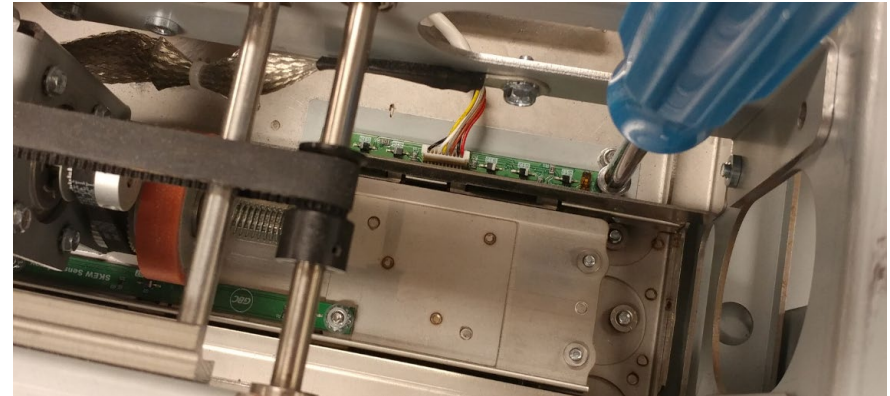

7. Remove the old Alignment Sensor PCB from the Upper Bypass.

### Installation Procedure

1. Place the new Alignment Sensor PCB onto the Upper Bypass by aligning it with the M3 studs. Ensure that S12 is oriented at the rear of the machine and S15 is oriented at the front of the machine.
2. Use the notch on the Alignment Sensor PCB mounting bracket to align the sensor board with the notch on the eWire.
3. Tighten the M3 Nuts to secure the PCB.
4. Connect the Sensor Cable to the PCB.
5. Do REP 1.1 [Top Cover Replacement](#) to install the Top Cover.
6. Connect the Power Cord.
7. Power ON the eWire.

## REP 2.16 Alignment Sensor Replacement, S41

### PARTS LIST ON PL 5.2

Use the following procedures to remove and install the Alignment Carriage Home Sensor, S41.

#### Removal Procedure

#### WARNING

**Do not perform repair activities with the power on or electrical power supplied to the machine. Some machine components contain dangerous electrical voltages that can result in electrical shock and possible serious injury. See Section 0, page vi for other languages.**

1. Switch power OFF to eWire.
2. Disconnect the Power Cord.
3. Raise the Upper Bypass Lid.
4. Remove the Sensor Bracket from the Steering Module by removing the M3 Screws (2).

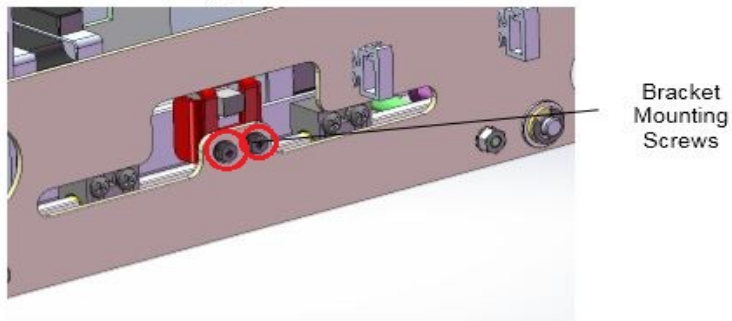

5. Disconnect the Cable Connector from the Sensor
6. Remove the Sensor from the Sensor Bracket by removing the M3 Screw.

#### Installation Procedure

1. Place the new Align Home Sensor into the Sensor Mounting Bracket, using the tabs to align the sensor.
2. Connect the Sensor Cable to the new Sensor.
3. Re-attach the Sensor Mounting Bracket by tightening the M3 Screws.
4. Do REP 1.1 [Top Cover Replacement](#) to install the Top Cover.
5. Connect the Power Cord.
6. Power ON the eWire.

## REP 2.17 Motor Driver (Stepper Driver) Replacement, M1 and M2

### PARTS LIST ON PL 5.4

Use this procedure to remove and install a Motor Driver (7715275) for the Bypass 1 and Bypass 2 Stepper Motors.

#### WARNING

**Do not perform repair activities with the power on or electrical power supplied to the machine. Some machine components contain dangerous electrical voltages that can result in electrical shock and possible serious injury. See Section 0, page vi for other languages.**

1. Switch power OFF to eWire.
2. Disconnect the Power Cord.
3. Do REP 1.1 [Top Cover Replacement](#) to remove the Top Cover.
4. Locate the appropriate Motor Driver (see PL 5.4).

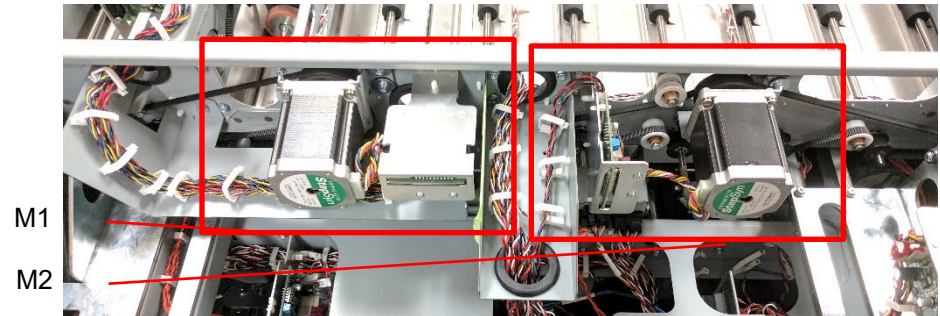

5. Disconnect the Connectors (3)

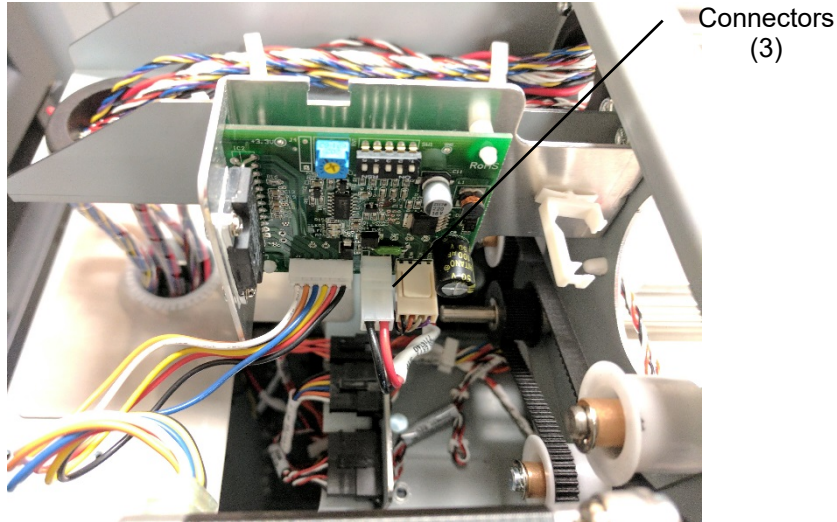

**Installation Procedure**

1. Place the new Stepper Driver onto the standoffs and snap it into place. Note the orientation of the Driver PCB.
2. Tighten the M2.5 Screws (2) to secure the vertical portion of the Driver.
3. Attach the Driver PCB Bracket into the Frame by securing the M4 Screws (2).
4. Set the Dip switches (6) on the new Motor Driver, using the correct settings for the Stepper Motor in question. Refer to GP 6.5 for DIP Switch settings.
5. Connect the Connectors (3).
6. Do REP 1.1 [Top Cover Replacement](#) to install the Top Cover.
7. Connect the Power Cord.
8. Power ON the eWire.

6. Remove the M4 Screws (2) and the Driver and Bracket Assembly.

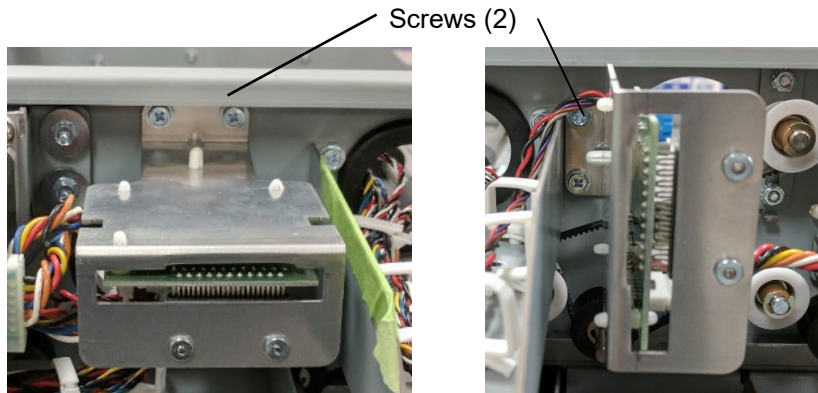

7. Remove the M2.5 Screws (2) from the vertical connector on the Stepper Driver. Remove the Stepper Driver by releasing it from the plastic standoffs.



## REP 2.18 Solenoid Replacement, Diverter Solenoid (L1)

### PARTS LIST ON PL 5.3

Use this procedure to remove and install the Diverter Solenoid Assembly.

#### Removal Procedure

#### WARNING

**Do not perform repair activities with the power on or electrical power supplied to the machine. Some machine components contain dangerous electrical voltages that can result in electrical shock and possible serious injury. See Section 0, page vi for other languages.**

1. Switch power OFF to eWire.
2. Disconnect the Power Cord.
3. Location of Diverter Solenoid shown below

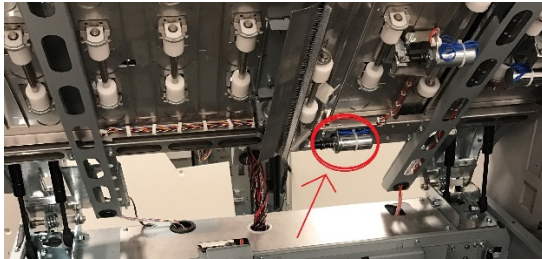

4. Remove M3 Screws (2) connecting the Solenoid linkage to the Diverter shaft.

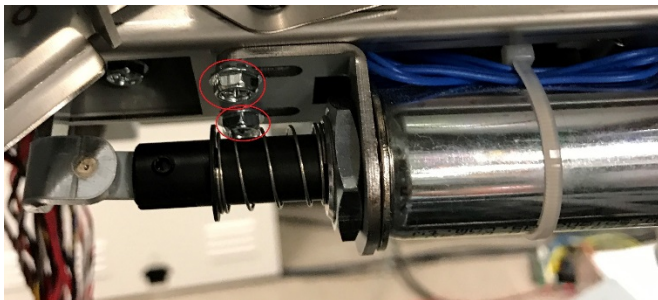

5. Remove M4 Screws (2) from the Diverter Solenoid Mount Bracket

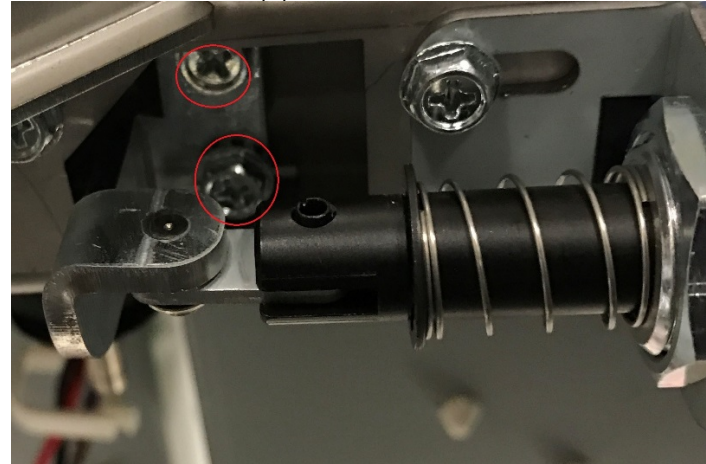

6. Disconnect the solenoid wires at the header

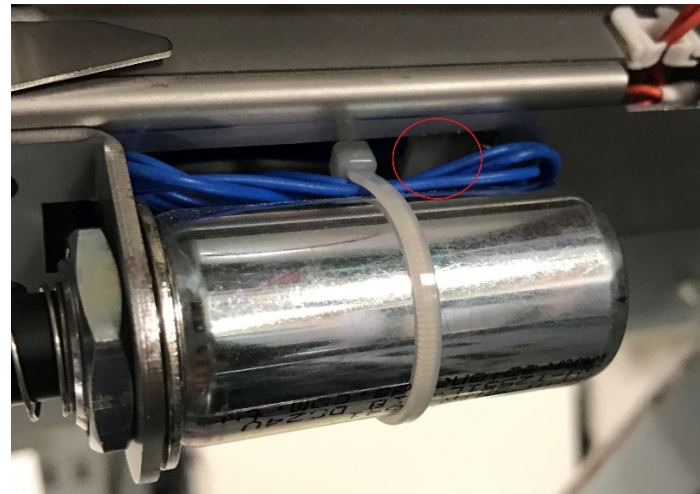

## Installation Procedure

1. Remove the Nut from the new Diverter Solenoid Linkage Assembly.
2. Thread the linkage through the mounting hole and place the Solenoid body into place on the Mounting Bracket. Loosely tighten the Solenoid Nut to the Solenoid threads.
3. Align the Diverter Solenoid Mounting Bracket onto the studs on the Bypass frame. Tighten the M4 nuts to secure the Solenoid Mounting Bracket.
4. Tighten the M4 Screws (2) to secure the linkage to the Diverter Shaft, rotating the Solenoid body as necessary to achieve alignment.
5. Tighten the Solenoid Nut to secure the Solenoid Body.
6. Connect the Solenoid Cables, threading the wires through the cable clamps.
7. Loosen the M4 screws (2) holding the mounting bracket to the frame so that the solenoid can be moved in the direction indicated.
8. Adjust the solenoid so that the diverter can achieve the full range of motion outlined below. Activate solenoid L1 in the LCD service menu to check the range

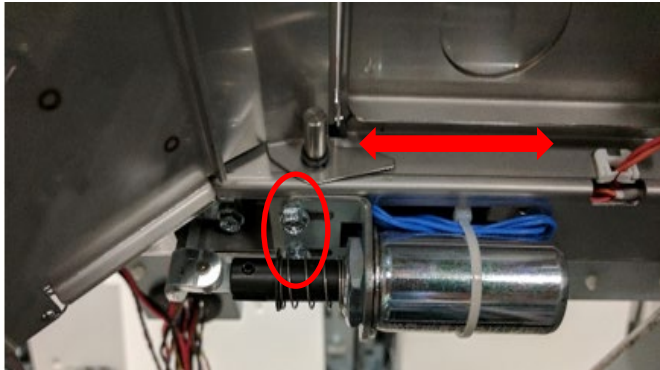

9. Using a scale, adjust the solenoid so that the diverter has lifted 5mm to 6mm above the lower paper path shown below:

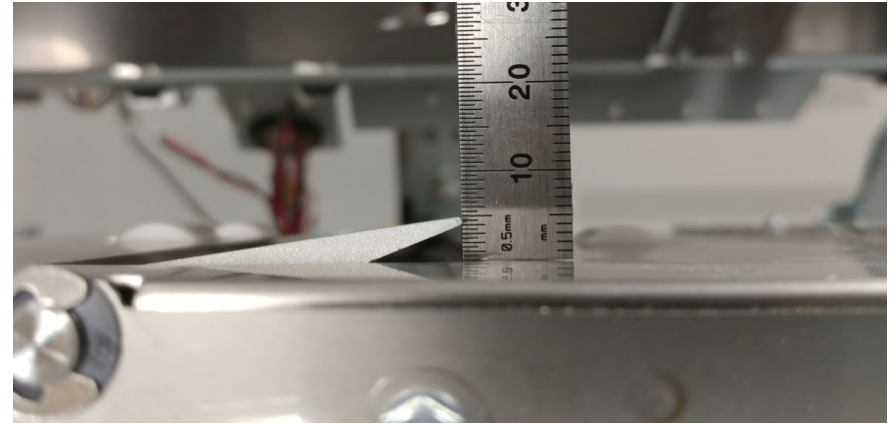

When L1 is deactivated, the diverter should be below the plane of the paper path as shown below



10. After adjusting the diverter, tighten the M4 screws (2) loosened in step 7.
11. Re-install the Lower Bypass Rear Cover.
12. Do REP 1.1 [Top Cover Replacement](#) to replace the Top.
13. Connect the Power Cord
14. Turn ON the eWire.

## REP 2.19 Solenoid Replacement, Disengaging Roller #1 and #2 (L2 & L3)

### PARTS LIST ON PL 5.3

Use this procedure to remove and install the Disengaging Roller #1 and #2 Solenoids. Solenoids L2 and L3 are part of the same sub-assembly (7717125) and must be replaced together.

### Removal Procedure

#### WARNING

**Do not perform repair activities with the power on or electrical power supplied to the machine. Some machine components contain dangerous electrical voltages that can result in electrical shock and possible serious injury. See Section 0, page vi for other languages.**

1. Switch power OFF to eWire.
2. Disconnect the Power Cord.
3. Open the top cover and lift the lower paper path.
4. Do REP 2.4 [Idle Roller Replacement, Paper Path](#) to remove the Idler Roller Assembly on the left and right side of the Disengaging Roller #1 and #2 sub-assembly (7717125).
5. Disconnect the Cables at the header and remove Cables from the wire clamps on the sub-assembly.

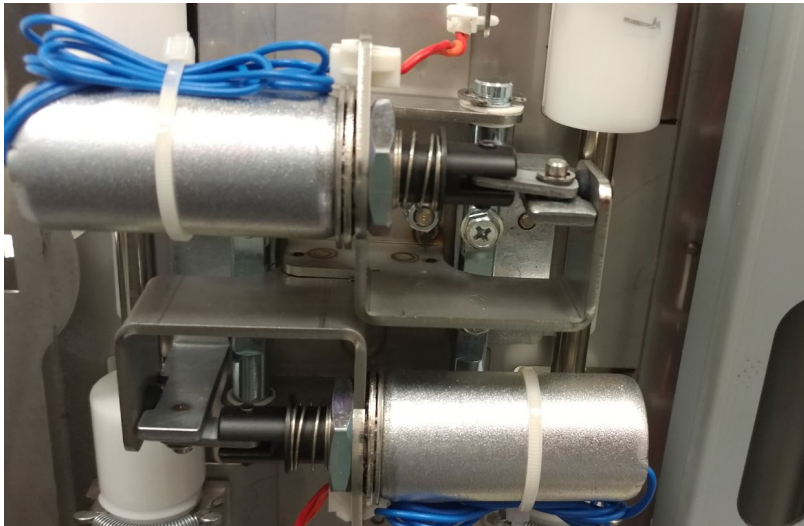

6. Remove the M4 Nuts (2) from the sub-assembly.

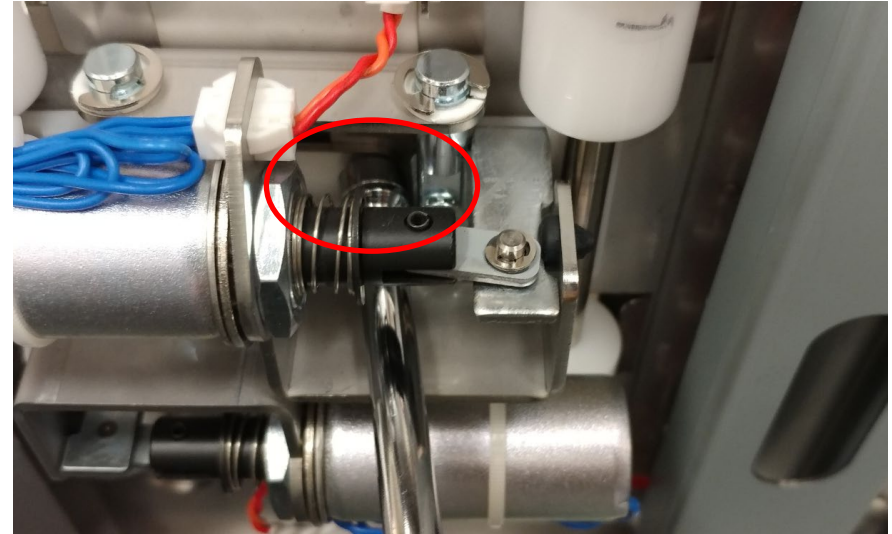

7. Remove the sub-assembly.

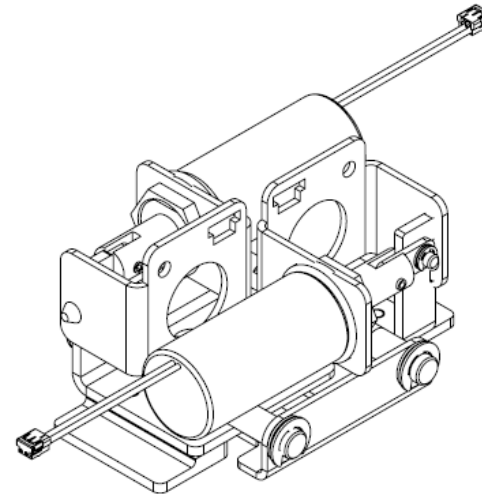

## Installation Procedure

1. Place the new 7717125 sub-assembly onto the appropriate mounting studs on the panel surface.
2. Tighten the M4 nuts (2) to secure the sub-assembly.
3. Do [REP 2.4 Idler Roller Replacement](#) to install the Idler Roller Assemblies (2).
4. Install the Solenoid Cables to the headers on the new sub-assembly, and secure the cables using wire clamps.
5. Connect the Power Cord
6. Turn on the eWire.

## REP 2.20 Solenoid Replacement, Disengaging Roller #3 (L4)

### PARTS LIST ON PL 5.3

Use this procedure to remove and install the Disengaging Roller #3 Assembly (7717128)

### Removal Procedure

#### WARNING

**Do not perform repair activities with the power on or electrical power supplied to the machine. Some machine components contain dangerous electrical voltages that can result in electrical shock and possible serious injury. See Section 0, page vi for other languages.**

1. Switch power OFF to eWire.
2. Disconnect the Power Cord.
3. Open the top cover and lift the lower paper path
4. Do REP 2.4 [Idler Roller Replacement, Paper Path](#) to remove the Idler Roller Assembly from the Disengaging Roller Assembly.
5. Disconnect the Cable at the header.

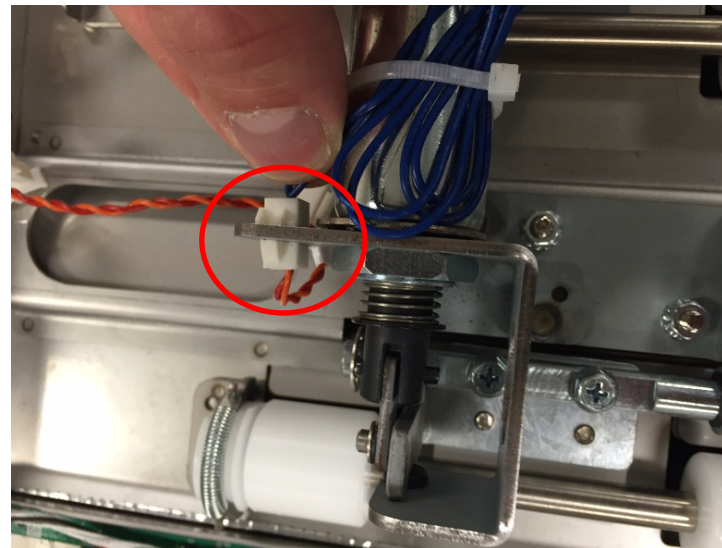

6. Remove the M4 Nuts (2) mounting the sub-assembly



7. Remove the entire Disengaging Roller #3 sub-assembly

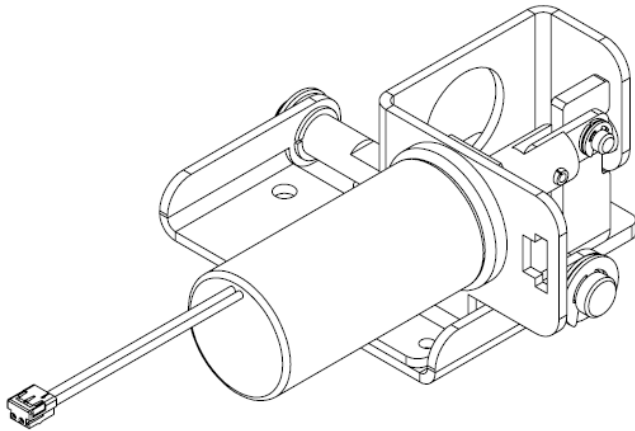

### Installation Procedure

1. Place the new 7717128 sub-assembly onto the appropriate mounting studs on the panel surface.
2. Tighten the M4 nuts (2) to secure the sub-assembly.
3. Do REP 2.4 [Idler Roller Replacement, Paper Path](#) to install the Idler Roller Assembly.
4. Install the Cable to the headers on the new sub-assembly.
5. Connect the Power Cord
6. Turn ON the eWire.

## REP 2.21 Steering Module Replacement

### PARTS LIST ON PL 5.6

Use the following procedures to remove and install the Steering Module, containing Nips N3 and N4.

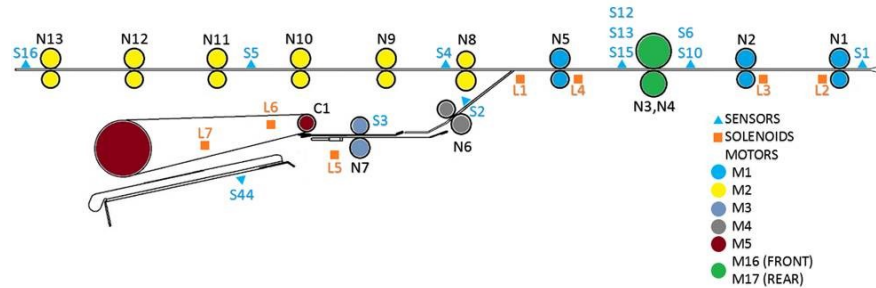

### Removal Procedure

#### WARNING

**Do not perform repair activities with the power on or electrical power supplied to the machine. Some machine components contain dangerous electrical voltages that can result in electrical shock and possible serious injury. See Section 0, page vi for other languages.**

1. Switch power OFF to eWire.
2. Disconnect the Power Cord.
3. Do REP 1.1 [Top Cover Replacement](#) to install the Top Cover.
4. Disconnect the Grounding Strap from the Frame by removing the M3 Screw
5. Disconnect the Cables from the Steering Module, located on the rear of the module.

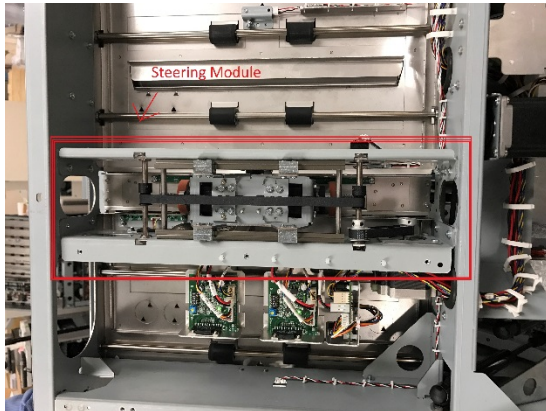

6. Disconnect the Steering Module Assembly by removing the M4 Screws from the front of the frame (4) and the back of the frame (4). Support the Steering Module with your free hand while removing the last screws.

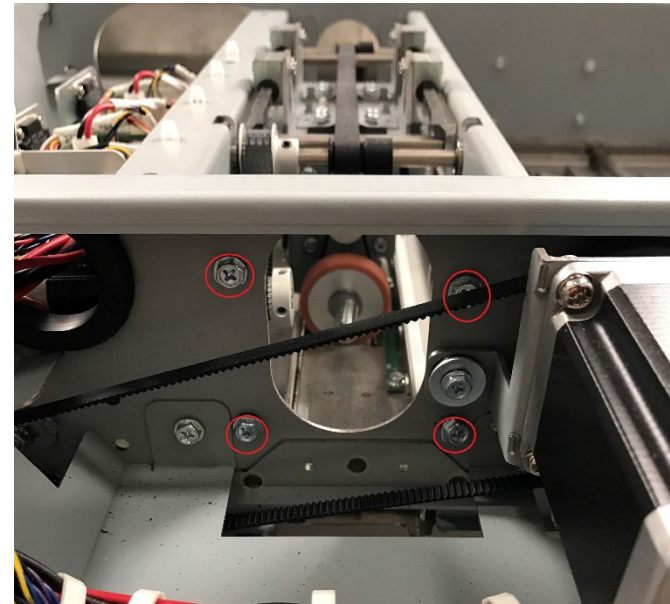

7. Carefully slide the Steering Module out of the Lower Bypass.

### Installation Procedure

1. Slide the new Steering Module Assembly into the Lower Bypass, aligning the M4 screw holes.
2. Tighten the M4 Screws on the front frame (4) and rear frame (3) to secure the Steering Module.
3. Re-connect the cables to the Steering Module.
4. Re-connect the Ground Strap.
5. Do REP 1.1 [Top Cover Replacement](#) to install the Top Cover.
6. Connect the Power Cord.
7. Power ON the eWire.

## REP 2.22 Steering Motor Replacement, M16 and M17

### PARTS LIST ON PL 5.3

Use the following procedures to remove and install the Steering Stepper Motors (M16 and M17)

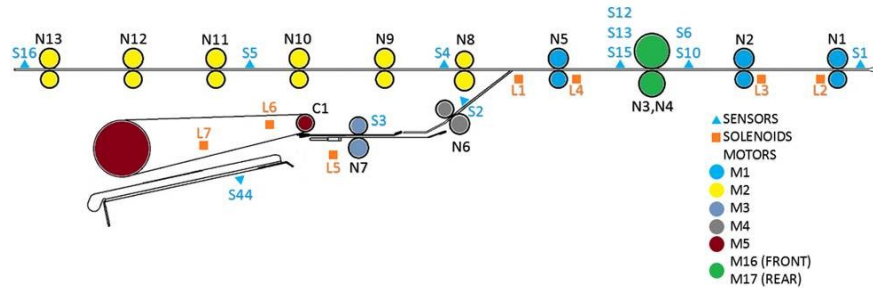

### Removal Procedure

#### WARNING

**Do not perform repair activities with the power on or electrical power supplied to the machine. Some machine components contain dangerous electrical voltages that can result in electrical shock and possible serious injury. See Section 0, page vi for other languages.**

1. Switch power OFF to eWire.
2. Disconnect the Power Cord.
3. Do REP 2.21 [Steering Module Replacement](#) to remove the Steering Module.
4. Do REP 2.2 [Drive Roller Replacement – Steering Module](#) to remove the Steering Drive Roller corresponding to the motor you are replacing.
5. Remove the Pulley from the motor shaft by loosening the set screw. Set aside the Pulley and Drive Belt.
6. Disconnect the Motor Cable from the corresponding Stepper Driver Board.
7. Disconnect the Motor by removing the M3 Screws (4), and remove the Motor from the Steering Module.

### Installation Procedure

1. Insert the new Stepper Motor into the Frame and secure it using the M3 Screws (4).
2. Connect the Motor Cable to the corresponding Stepper Driver Board.
3. Slide the Pulley and Belt onto the Motor shaft and secure the Pulley using the set screw.
4. Do REP 2.2 [Drive Roller Replacement – Steering Module](#) to replace the Steering Drive Roller Assembly.
5. Do REP 2.21 [Steering Module Replacement](#) to replace the Steering Module.
6. Connect the Power Cord.
7. Power ON the eWire.

## REP 2.23 Alignment Motor Replacement, M18

### PARTS LIST ON PL 5.3

Use the following procedures to remove and install the Alignment Stepper Motor (M18). The Alignment Stepper Motor moves the entire Steering Module.

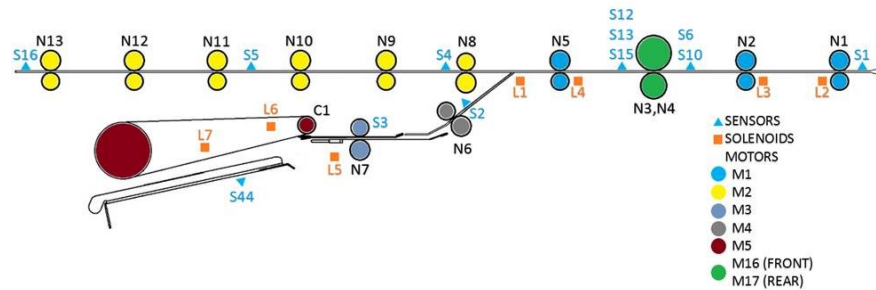

### Removal Procedure

#### WARNING

**Do not perform repair activities with the power on or electrical power supplied to the machine. Some machine components contain dangerous electrical voltages that can result in electrical shock and possible serious injury. See Section 0, page vi for other languages.**

1. Switch power OFF to eWire.
2. Disconnect the Power Cord.
3. Do REP 2.21 [Steering Module Replacement](#) to remove the Steering Module.
4. Remove the Motor Cable from the corresponding Stepper Driver Board.
5. Loosen the M4 Screws (4) securing the Alignment Motor, and shift the motor towards the center of the Steering Module to reduce tension on the Motor Belt.
6. Remove the Pulley from the Motor shaft by loosening the set screw and sliding the Pulley off the shaft.
7. Disconnect the Motor by removing the M3 Screws (4), and remove the Motor from the Steering Module.

### Installation Procedure

1. Insert the new Stepper Motor into the Frame and secure it loosely using the M3 Screws (4).
2. Slide the Pulley and Belt onto the Motor shaft and secure the Pulley using the set screw.
3. Shift the Stepper Motor away from the center of the Steering Module to provide appropriate tension on the Drive Belt. Secure the Stepper Motor using the M3 Screws (4).
4. Connect the Motor cable to the corresponding Stepper Driver Board.
5. Do REP 2.21 [Steering Module Replacement](#) to replace the Steering Module.
6. Connect the Power Cord.
7. Power ON the eWire.



## REP 2.24 Motor Driver (Stepper Driver) Replacement, M4, M16, M17, and M18

### PARTS LIST ON PL 5.6

Use this procedure to remove and install a Motor Driver (7715275) for the Steering and Alignment Stepper Motors.

### Removal Procedure

#### WARNING

**Do not perform repair activities with the power on or electrical power supplied to the machine. Some machine components contain dangerous electrical voltages that can result in electrical shock and possible serious injury. See Section 0, page vi for other languages.**

1. Switch power OFF to eWire.
2. Disconnect the Power Cord.
3. Do REP 2.21 [Steering Module Replacement](#) to remove the Steering Module.
4. Locate the appropriate Motor Driver.
5. Disconnect the Connectors (3)

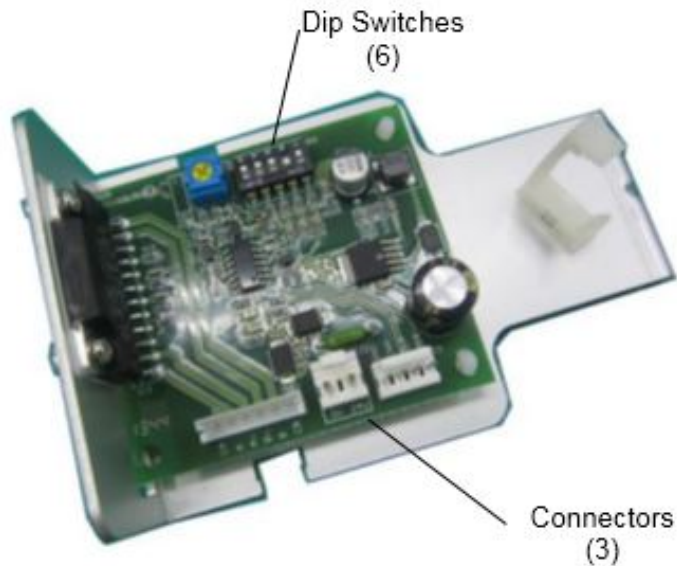

6. Remove the M4 Screws (2) and the Driver and Bracket Assembly.

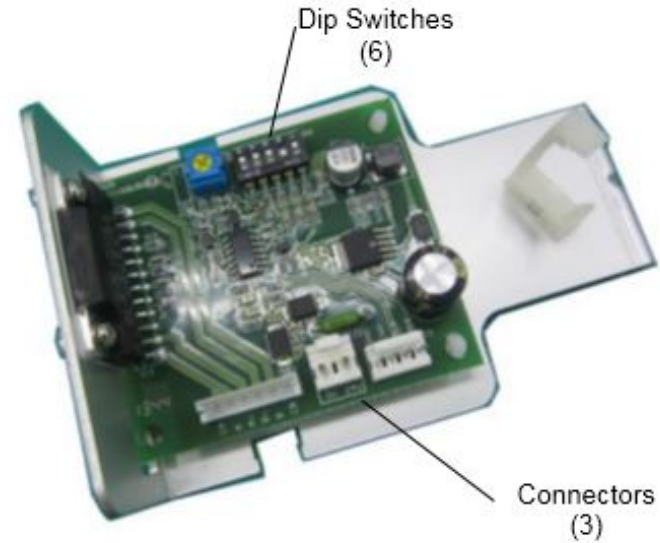

7. Remove the M2.5 Screws (2) from the vertical connector on the Stepper Driver. Remove the Stepper Driver by releasing it from the plastic standoffs.

### Installation Procedure

1. Place the new Stepper Driver onto the standoffs and snap it into place.
2. Tighten the M2.5 Screws (2) to secure the vertical portion of the Driver.
3. Attach the Driver PCB Bracket into the Frame by securing the M4 Screws (2).
4. Connect the Connectors (3).
5. Set the Dip switches (6) on the new Motor Driver in accordance with the DIP Switch values indicated in GP 6.5.

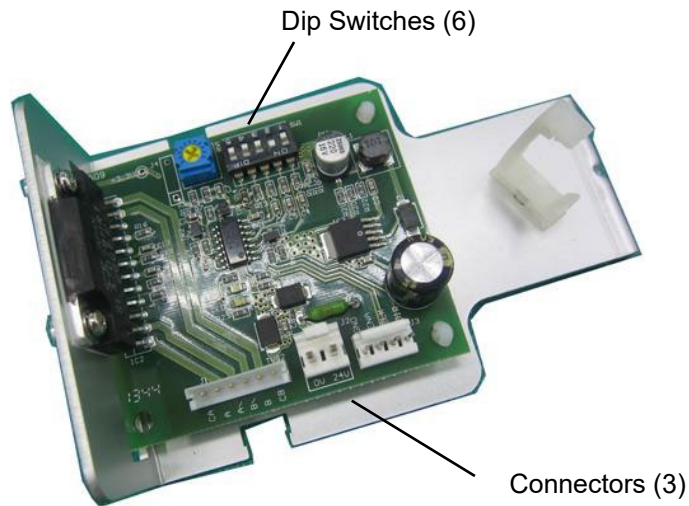

6. Do REP 1.1 [Top Cover Replacement](#) to install the Top Cover.
7. Connect the Power Cord.
8. Power ON the eWire.

### REP 2.25 Anti-Static Brush Replacement

#### PARTS LIST ON PL 5.4

Use this procedure to remove and install the Anti-Static Brush to the Paper Transport.

#### Removal Procedure

#### WARNING

**Do not perform repair activities with the power on or electrical power supplied to the machine. Some machine components contain dangerous electrical voltages that can result in electrical shock and possible serious injury. See Section 0, page vi for other languages.**

1. Switch power OFF to eWire.
2. Disconnect the Power Cord.
3. Do REP 1.1 [Top Cover Replacement](#) to remove the Top Cover.
4. Using a straight edge razor, peel up the edge of the Anti-Static Brush (3) and carefully remove it from the metal surface.

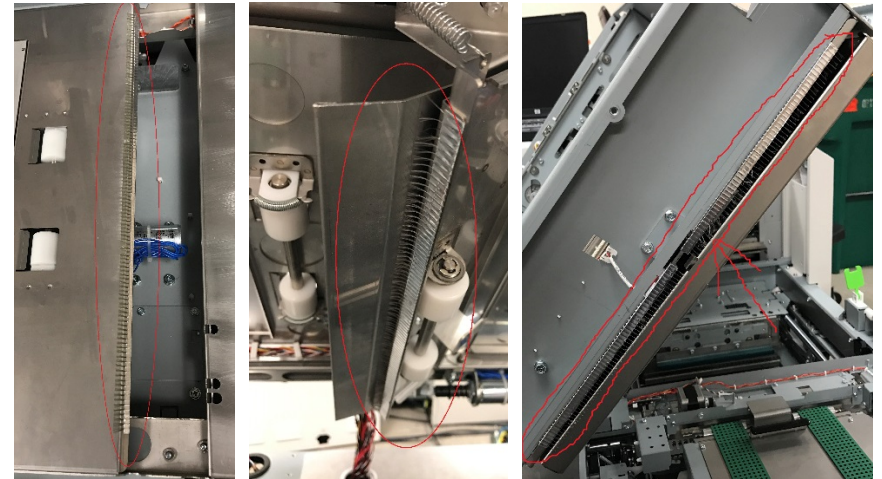

Make sure tape is 1 mm from bend/edge

5. Use a cloth and alcohol to remove any adhesive residue from the surface.

## Installation Procedure

1. Ensure the mounting surface is clean and free of residue. If necessary, clean the surface with a cloth.
2. Peel the backing away from the new Brush and position it on the metal surface. Apply pressure along the length of the Brush to adhere it to the surface.
3. Do REP 1.1 [Top Cover Replacement](#) to install the Top Cover.
4. Connect the Power Cord.
5. Power ON the eWire.

## REP 2.26 Upper Transport Latch Replacement

### PARTS LIST ON PL 5.4

Use this procedure to remove and install the latch on the Upper Bypass Assembly.

### Removal Procedure

#### WARNING

**Do not perform repair activities with the power on or electrical power supplied to the machine. Some machine components contain dangerous electrical voltages that can result in electrical shock and possible serious injury. See Section 0, page vi for other languages.**

1. Switch power OFF to eWire.
2. Disconnect the Power Cord.
3. Do REP 1.1 [Top Cover Replacement](#) to remove the Top Cover.
4. While supporting the upper transport with your free hand, release the latch by pressing down on the pivot arm. Raise the Upper Bypass carefully, it will rise quickly without the weight of the cover.
5. Remove the old Latch Assembly by removing the M4 Screws (4)

### Installation Procedure

1. Place the new Latch onto the Upper Transport surface and secure it using the M4 Screws (4).
2. Lower the Upper Bypass and gently seat the Upper Bypass by pressing down on the Upper Bypass. If horizontal adjustment of the Interlock Bracket is required, do REP 1.8 [Front Cover Replacement](#) to remove the Front Cover.



3. Close the latch by lowering the Upper Bypass Assembly fully. Ensure that the latch engages properly with the Catch. If necessary, adjust the vertical position of the Catch by loosening the Screws on the Catch Bracket and adjusting the position. A properly seated cover will have around 1mm of movement.
4. Do REP 1.1 [Top Cover Replacement](#) to install the Top Cover.
5. Connect the Power Cord.
6. Power ON the eWire.

## REP 2.27 Lower Transport Latch Replacement

### PARTS LIST ON PL 5.4

Use this procedure to remove and install the latch on the Lower Bypass Assembly.

#### Removal Procedure

#### **WARNING**

**Do not perform repair activities with the power on or electrical power supplied to the machine. Some machine components contain dangerous electrical voltages that can result in electrical shock and possible serious injury. See Section 0, page vi for other languages.**

1. Switch power OFF to eWire.
2. Disconnect the Power Cord.
3. Raise the Upper Bypass and Lower Bypass.
4. Remove the old Latch by removing the M4 Screws (2)

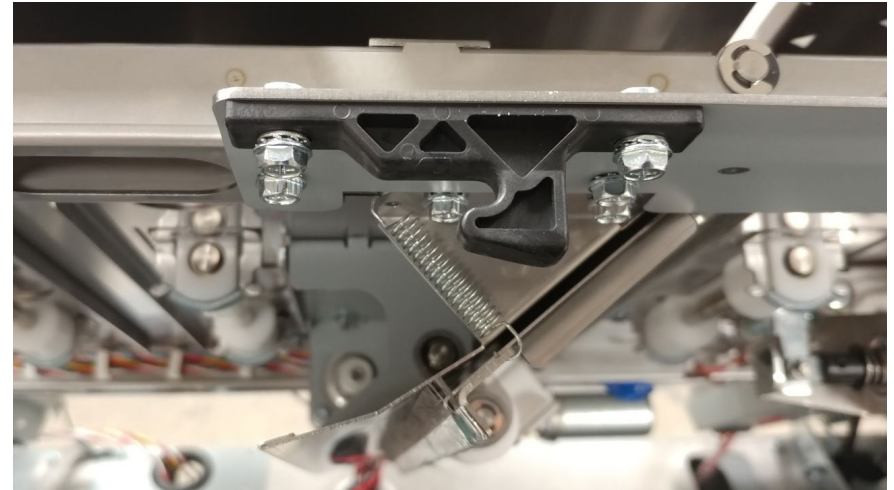

## Installation Procedure

1. Place the new Latch onto the Lower Transport surface and secure it with the M4 Screws (2).
1. Close the Lower Transport and ensure that the latch mates easily with housing. If necessary, loosen the screws on the latch hook or mating housing and adjust the position to ensure proper fit.
2. Connect the Power Cord.
3. Power ON the eWire

## REP 2.28 M4 Motor Replacement

### PARTS LIST ON PL 5.4

Use this procedure to remove and install the M4 Motor on the Upper Paper Transport Assembly Baffle.

### Removal Procedure

#### **WARNING**

**Do not perform repair activities with the power on or electrical power supplied to the machine. Some machine components contain dangerous electrical voltages that can result in electrical shock and possible serious injury. See Section 0, page vi for other languages.**

1. Switch power OFF to eWire.
2. Disconnect the Power Cord.
3. Raise the Upper Bypass and Lower Bypass.
4. Remove the Upper Baffle by removing the M4 Screws (4) and Locating Pin, which is attached with an M3 Screw. Slide the Upper Baffle off of the remaining Locating Pins to remove.

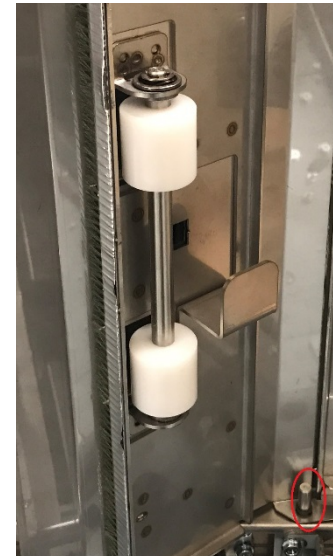

5. Remove bracket by removing the M4 Screws (2)

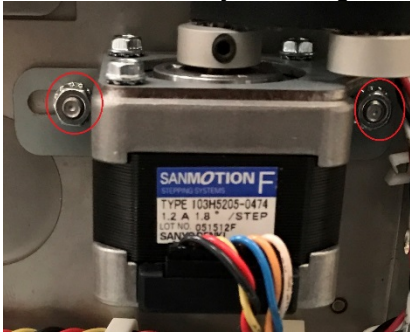

6. Remove M4 Motor from bracket by removing the M4 Screws (3)

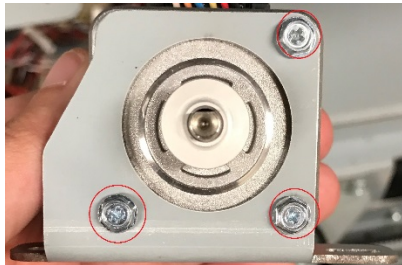

### Installation Procedure

1. Attach new motor to bracket with M4 Screws (3).
2. Attach bracket to Upper Paper Transport with M4 Screws (2).
3. Slide Upper Baffle onto Locating Pins and attach the Locating Pin that was removed in Step 4 with an M3 Screw.
4. Secure Upper Baffle with M4 Screws (4) removed in Step 4.
5. Connect the Power Cord.
6. Power ON the eWire.

### 3. Element Feeder

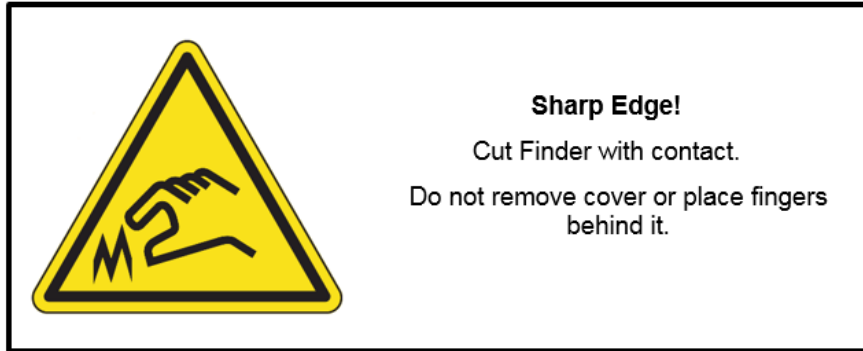

#### REP 3.1 Element Slack Sensor Replacement – S20

##### PARTS LIST ON PL 5.7

Use this procedure to remove and install the Element Slack Sensor.

##### Removal Procedure

#### WARNING

**Do not perform repair activities with the power on or electrical power supplied to the machine. Some machine components contain dangerous electrical voltages that can result in electrical shock and possible serious injury. See Section 0, page vi for other languages.**

1. Switch power OFF to eWire.
2. Disconnect the Power Cord.
3. Open the Front Door and slide out the Element Feeder drawer.
4. Do GP 6.13 to remove the Supply Spool, Rewind Spool, Spool Detect Cover and Rear Baffle.
5. Disconnect the Sensor Cable.
6. Remove the Sensor Bracket by removing the M3 Screws (2)

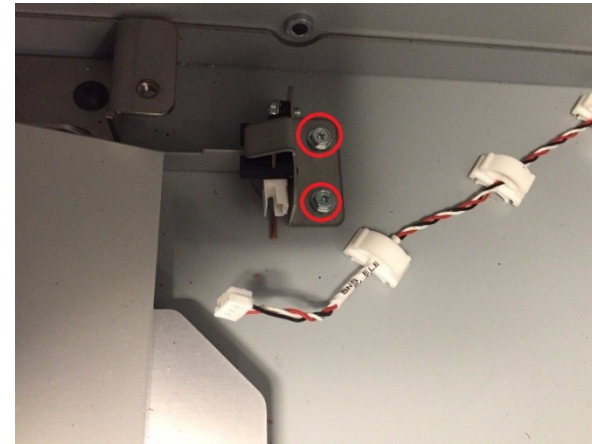

7. Remove the Sensor from the Sensor Bracket by removing the M3 Screw.

##### Installation Procedure

1. Reverse the steps in the Removal Procedure.
2. Connect the Power Cord.
3. Power ON the eWire.

## REP 3.2 Element Detect at Pyramid Sensor Replacement – S22 PARTS LIST ON PL 5.7

Use this procedure to remove and install the Element Detect at Pyramid Sensor. Note: The S22 Sensor consists of two parts – an Emitter and a Receiver.

### Removal Procedure

#### WARNING

**Do not perform repair activities with the power on or electrical power supplied to the machine. Some machine components contain dangerous electrical voltages that can result in electrical shock and possible serious injury. See Section 0, page vi for other languages.**

1. Switch power OFF to eWire.
2. Disconnect the Power Cord.
3. Do REP 3.6 [Element Feeder Belt Replacement](#) to remove the Element Feed Belt.
4. Disconnect the 4 Sensor Cables that run to the Element Feed Track Assembly. Note that the Header is fixed and the Sensor Cables can be removed from the Header by gently pulling on the cables.

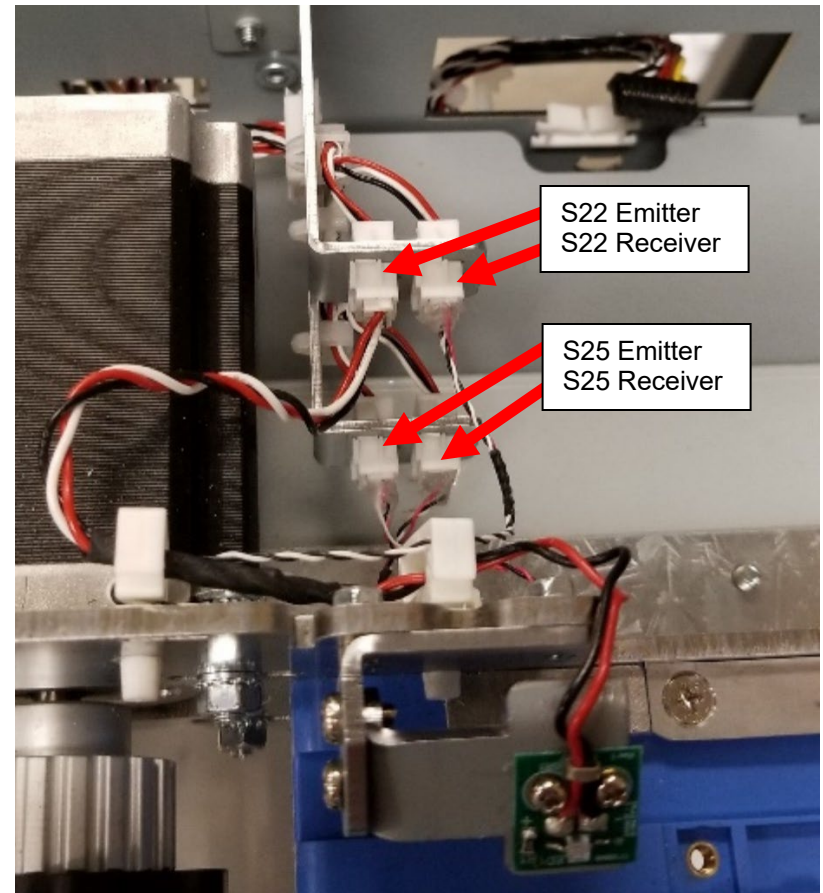

5. Remove the Element Feed Track Assembly by removing the M4 Screws (3).

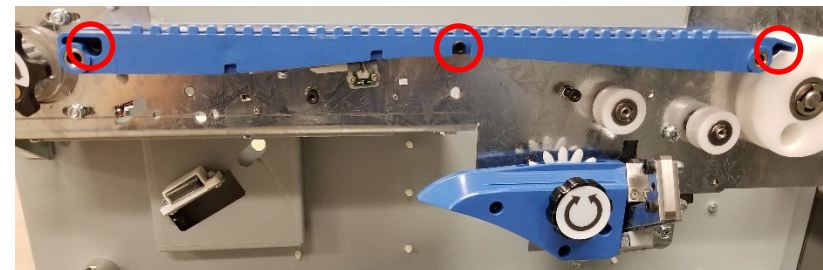



6. Locate the Receiver PCB on the back of the Element Feed Track Assembly. Remove the M2 Screws (2) to remove the Receiver PCB. Take note of the PCB's orientation.

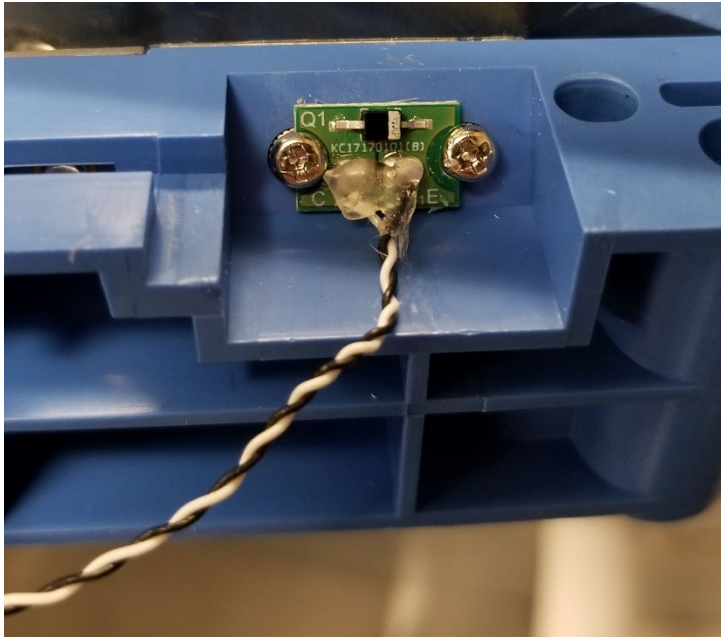

7. Remove the M2 Screws (2) to remove the Emitter PCB.

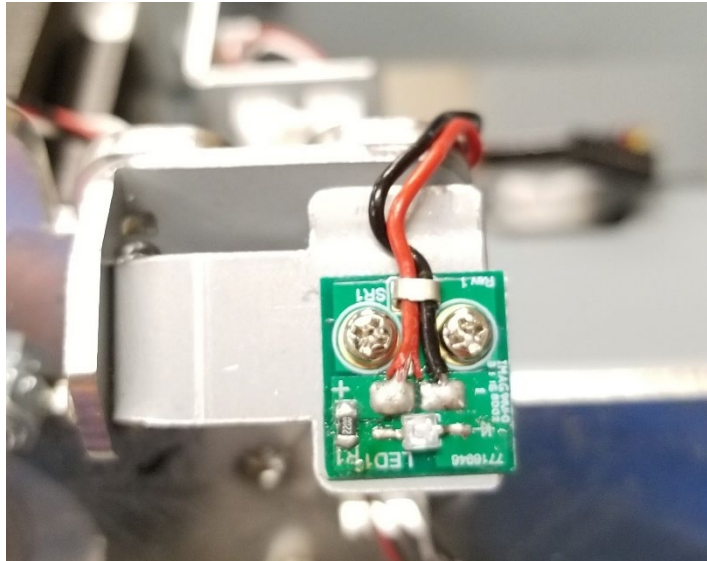

### Installation Procedure

1. Use caution when handling the new Emitter and Receiver PCBs as the wires could be damaged if too much force is applied.
2. Reverse the steps in the Removal Procedure. **Caution:** Do not overtighten the M2 Screws.
3. Run the S25 Emitter and Receiver cables along the groove in the Element Feed Track and feed the ends, along with the S22 Receiver cable through the opening. **Caution:** Take care that the cables are not being pinched when reinstalling the Element Feed Track Assembly and that there is no gap between the track and panel it mounts to.



4. Reconnect the 4 Sensor Cables as shown in Step 4 of the Removal Procedure.
5. Connect the Power Cord.
6. Power ON the eWire.

### REP 3.3 Element Belt Home Sensor Replacement – S25

#### PARTS LIST ON PL 5.7

Use this procedure to remove and install the Element Belt Home Sensor.  
Note: the S25 Sensor consists of two parts – an Emitter and a Receiver.

#### Removal Procedure

#### WARNING

**Do not perform repair activities with the power on or electrical power supplied to the machine. Some machine components contain dangerous electrical voltages that can result in electrical shock and possible serious injury. See Section 0, page vi for other languages.**

1. Switch power OFF to eWire.
2. Disconnect the Power Cord.
3. Do REP 3.6 [Element Feeder Belt Replacement](#) to remove the Element Feed Belt.
4. Disconnect the 4 Sensor Cables that run to the Element Feed Track Assembly. Note that the Header is fixed and the Sensor Cables can be removed from the Header by gently pulling on the cables.

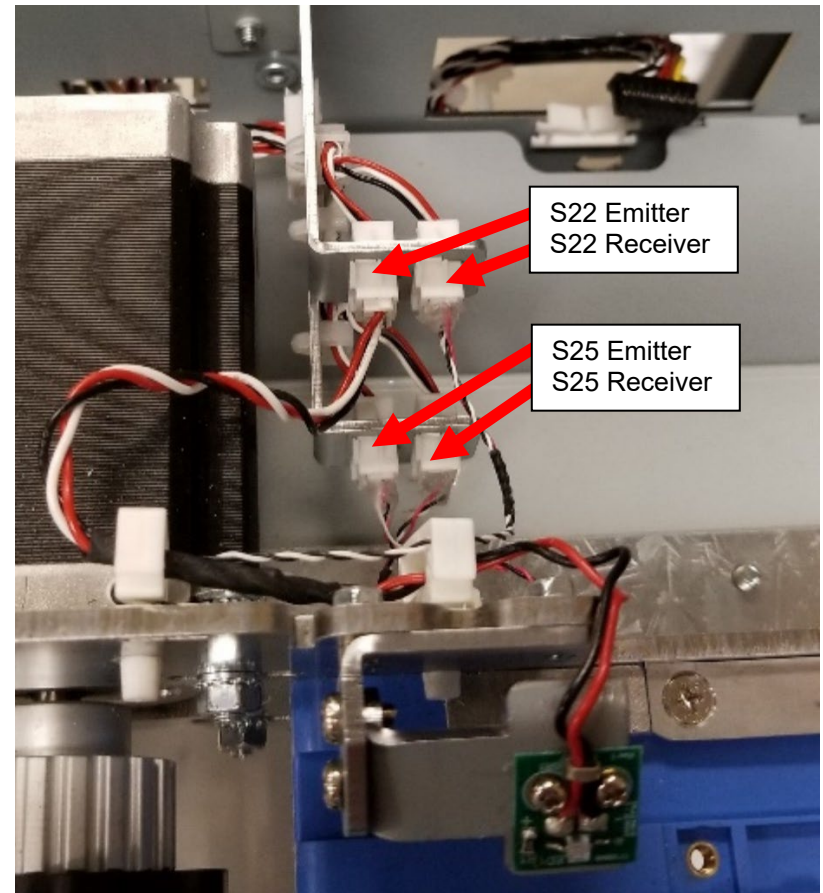

5. Remove the Element Feed Track Assembly by removing the M4 Screws (3).

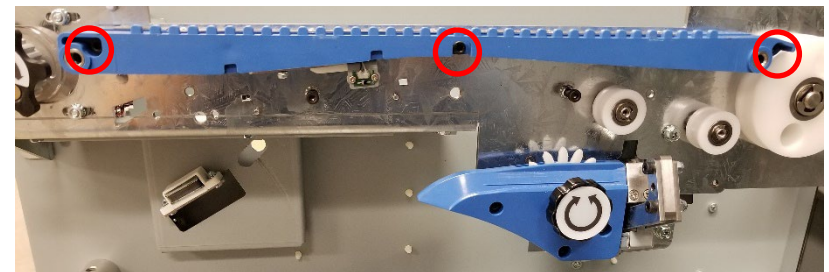

6. Remove the Belt Detect Sensor Bracket by removing the M3 Screw.

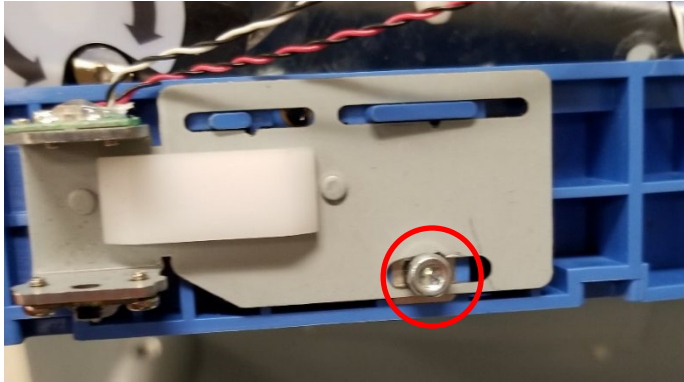

7. Remove the Emitter PCB from the Belt Detect Sensor Bracket by removing the M2 Screws (2).
8. Remove the Receiver PCB from the Belt Detect Sensor Bracket by removing the M2 Screws (2).

### Installation Procedure

1. Use caution when handling the new Emitter and Receiver PCBs as the wires could be damaged if too much force is applied.
2. Reverse the steps in the Removal Procedure. **Caution:** Do not overtighten the M2 Screws. The wires coming out of the Receiver PCB should run underneath the Belt Detect Sensor Bracket.
3. Run the S25 Emitter and Receiver cables along the groove in the Element Feed Track and feed the ends, along with the S22 Receiver cable through the opening. **Caution:** Take care that the cables are not being pinched when reinstalling the Element Feed Track Assembly and that there is no gap between the track and panel it mounts to.



4. Reconnect the 4 Sensor Cables as shown in Step 4 of the Removal Procedure.
5. Power ON the eWire.
6. Do ADJ 1.4 [Element Feed Belt Home Position](#) to set the position of the Belt Detect Sensor Bracket.

## REP 3.4 Spool Detect Sensor Replacement – S26-S30

### PARTS LIST ON PL 5.7

Use this procedure to remove and install the Spool Detect Sensor(s).  
Note that the Spool Detect Sensors are located on the Spool Detect PCB 7717206.

### Removal Procedure

#### WARNING

**Do not perform repair activities with the power on or electrical power supplied to the machine. Some machine components contain dangerous electrical voltages that can result in electrical shock and possible serious injury. See Section 0, page vi for other languages.**

1. Switch power OFF to eWire.
2. Disconnect the Power Cord.
3. Open the Front Door and slide out the Element Feeder drawer.
4. Do GP 6.8 to remove the Supply Spool.
5. Remove the Spool Detect Sensor Cover by removing the M4 Screws (2).



6. Remove the M3 Screws (2) holding the Spool Detect Sensor PCB.

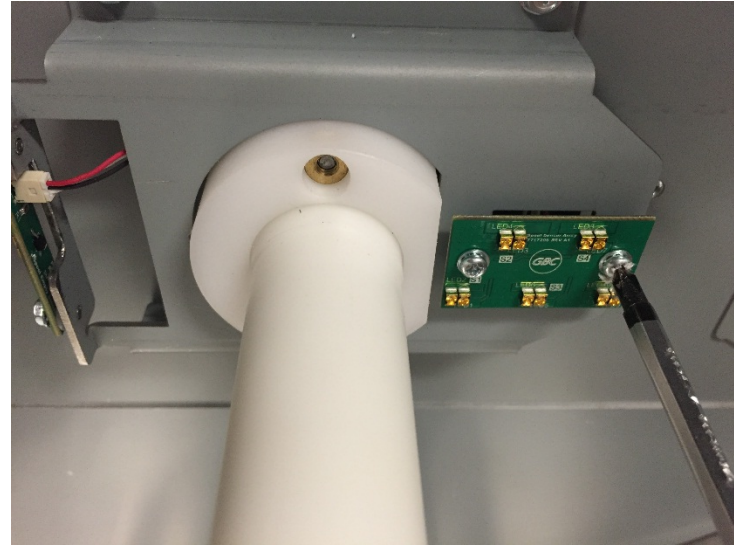

7. Disconnect the Sensor Cable from the back side of the PCB, and remove the Spool Detect Sensor PCB.

### Installation Procedure

1. Reverse the steps in the Removal Procedure.
2. Connect the Power Cord.
3. Power ON the eWire.

## REP 3.5 Spool Near-Empty Sensor Replacement – S50

### PARTS LIST ON PL 5.7

Use this procedure to remove and install the Spool Near-Empty Detect Sensor. Note that the Sensor is located on the Spool Empty PCB 7717479.

### Removal Procedure

#### WARNING

**Do not perform repair activities with the power on or electrical power supplied to the machine. Some machine components contain dangerous electrical voltages that can result in electrical shock and possible serious injury. See Section 0, page vi for other languages.**

1. Switch power OFF to eWire.
2. Disconnect the Power Cord.
3. Do GP 6.8 to remove the Supply Spool.
4. Remove the Spool Detect Sensor Cover by removing the M4 Screws (2).

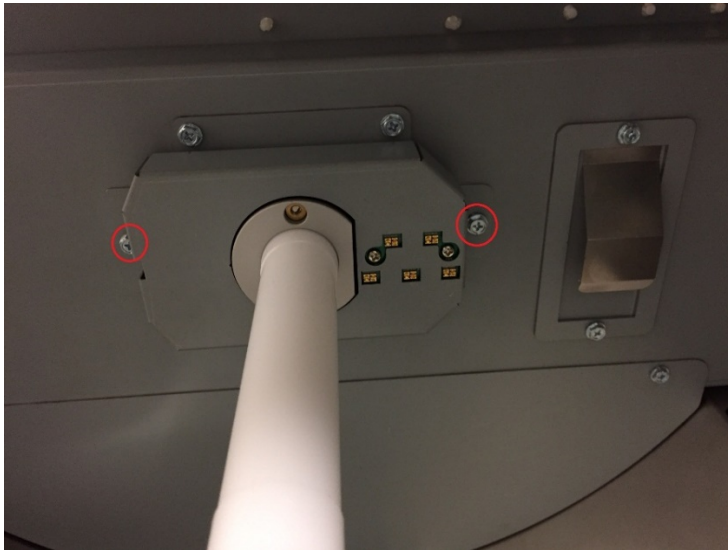

5. Remove the M3 Screws (2) holding the Spool Empty PCB.



6. Disconnect the Sensor Cable from the back side of the PCB.

### Installation Procedure

1. Reverse the steps in the Removal Procedure.
2. Connect the Power Cord.
3. Power ON the eWire.

## REP 3.6 Element Feeder Belt Replacement

### PARTS LIST ON PL 5.8

Use this procedure to remove and install the Element Feeder Belt.

#### Removal Procedure

#### WARNING

Do not perform repair activities with the power on or electrical power supplied to the machine. Some machine components contain dangerous electrical voltages that can result in electrical shock and possible serious injury. See Section 0, page vi for other languages.

1. Switch power OFF to eWire.
2. Disconnect the Power Cord.
3. Do GP 6.8 to remove the Supply Spool.
4. Do REP 3.15 [Element Transfer Module Replacement](#) to remove the Element Transfer Module.
5. Remove the M3 nuts (2) and the Element Belt Guard.

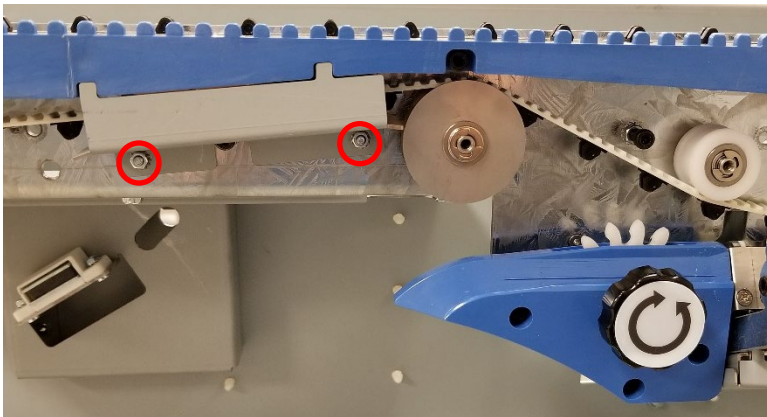

6. Do REP 3.11 [Element Feed Belt Idler Replacement](#) to remove the Element Feed Belt Idler.
7. Do REP 3.13 [Element Engagement Guide Replacement](#) to remove the Element Engagement Guide Assembly.
8. Remove the M3 Flat Head Screws (5) and the front Belt Retainer Plate.

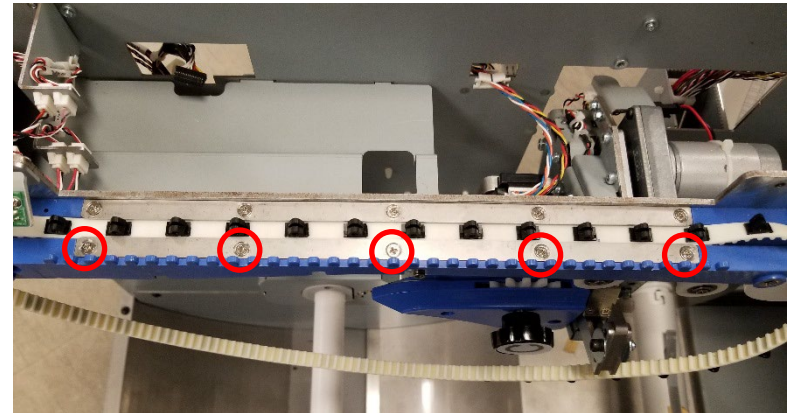

9. Remove the Element Feeder Belt.



#### Installation Procedure

1. Reverse the steps in the Removal Procedure. Ensure that the Element Feeder Belt sits beneath both Belt Retainer Plates.
2. Use the knob to manually move the belt. The belt should move easily and should not stick at any point.
3. Do ADJ 1.4 [Element Feed Belt Home Position](#) to verify the home position is set correctly.
4. Connect the Power Cord.
5. Power ON the eWire.

## REP 3.7 Element Feed Belt Motor Replacement, M10

### PARTS LIST ON PL 5.8

Use this procedure to remove and install the Element Feed Belt Stepper Motor.

#### Removal Procedure

#### WARNING

**Do not perform repair activities with the power on or electrical power supplied to the machine. Some machine components contain dangerous electrical voltages that can result in electrical shock and possible serious injury. See Section 0, page vi for other languages.**

1. Switch power OFF to eWire.
2. Disconnect the Power Cord.
3. Open the Front Door and slide out the Element Feeder drawer.
4. Do GP 6.8 to remove the Supply Spool.
5. Remove the Element Feeder Door. Follow procedure REP 1.2 to remove the Element Feeder Door.
6. Remove the Upper Element Feeder Cover by removing the M4 Screws (2).

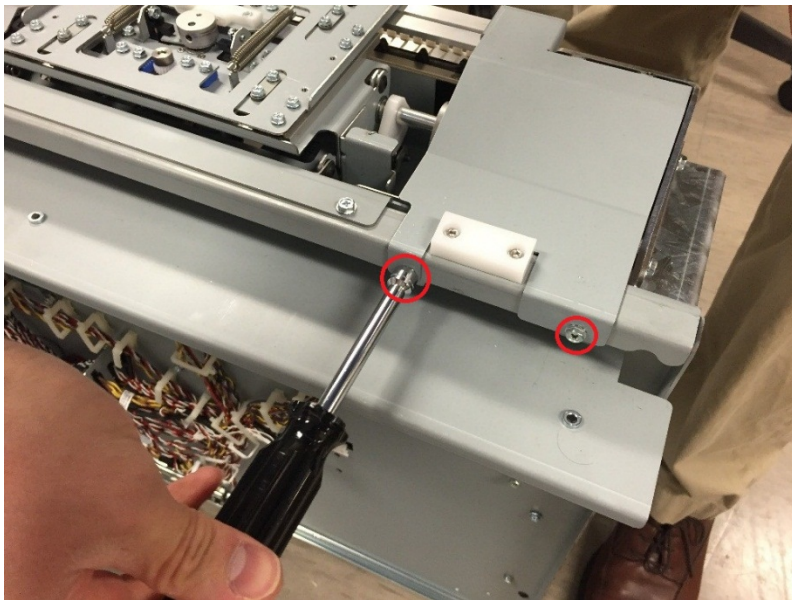

7. Remove the Rear Cover by removing the M4 Screws (8)

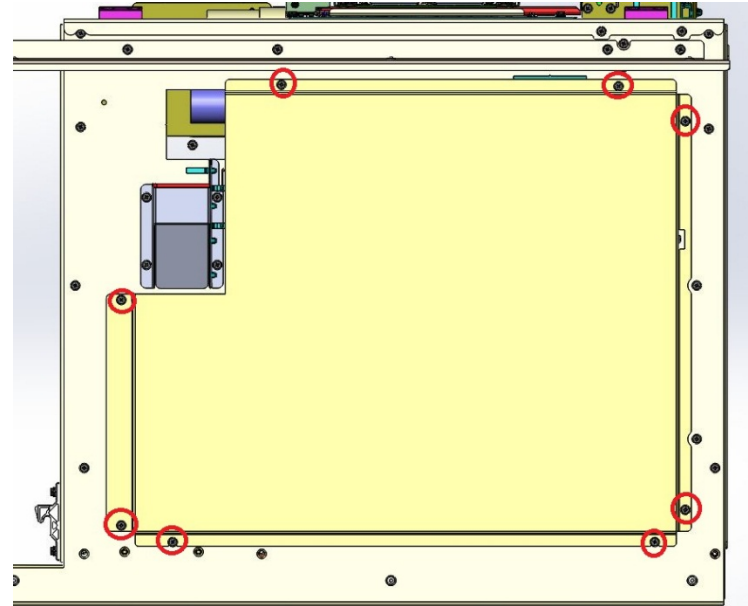

8. Disconnect the Motor Cable from the Stepper Motor Driver.

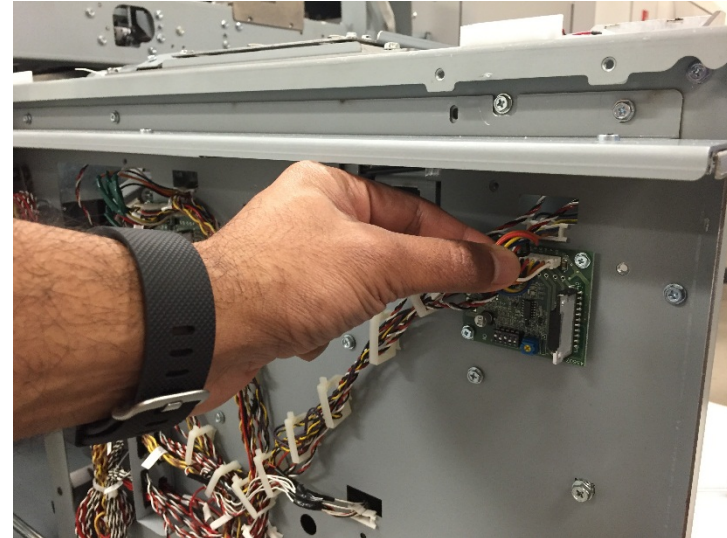

9. Loosen the set screw on the Element Belt Pulley.

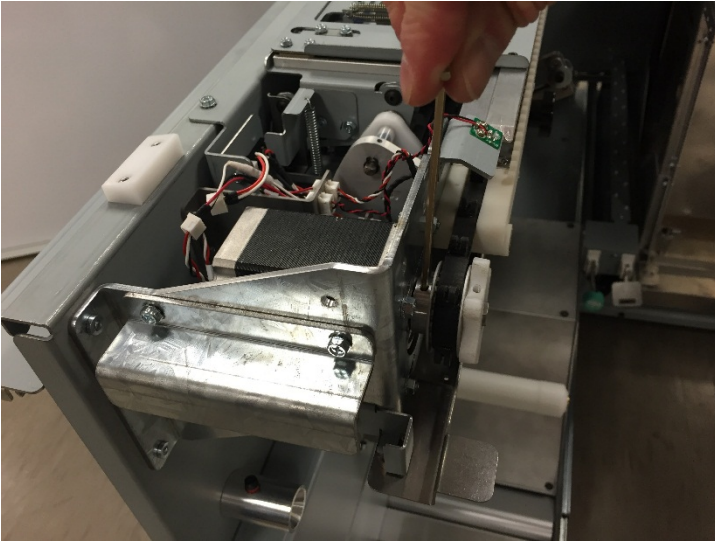

10. Remove the M4 Nuts (4) securing the Motor to the frame, and remove the Motor.

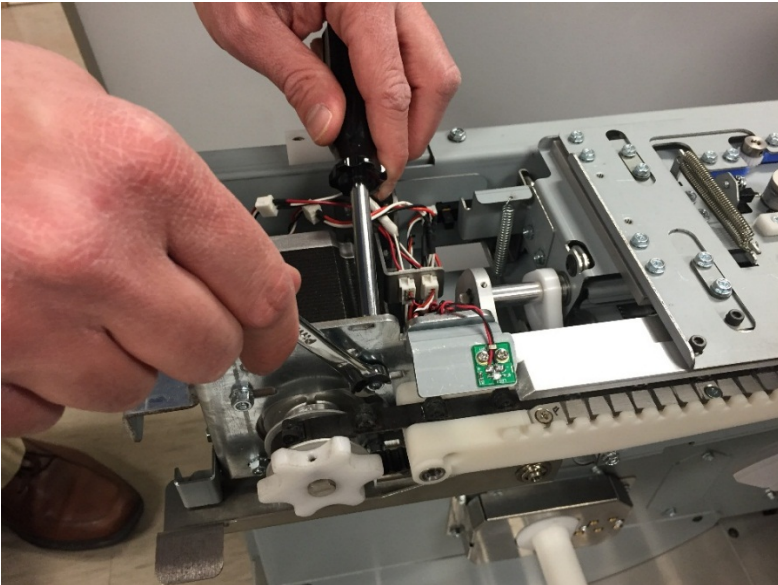

### Installation Procedure

1. Insert the new Motor into the slots on the frame, and loosely attach the M4 nuts (4) to secure it.
2. Slide the pulley onto the motor shaft, and adjust the pulley position until the belt has proper tension. Tighten the mounting screws to secure the motor.
3. Tighten the Pulley to the motor shaft by securing the set screw.
4. Connect the Motor cables to the Stepper Motor Driver.
5. Re-attach all covers by reversing the steps in the Removal Procedure.
6. Connect the Power Cord.
7. Power ON the eWire.



## REP 3.8 Element Feed Sprocket Motor Replacement, M9

### PARTS LIST ON PL 5.8

Use this procedure to remove and install the Element Feed Belt Sprocket Stepper Motor.

#### Removal Procedure

#### WARNING

**Do not perform repair activities with the power on or electrical power supplied to the machine. Some machine components contain dangerous electrical voltages that can result in electrical shock and possible serious injury. See Section 0, page vi for other languages.**

1. Switch power OFF to eWire.
2. Disconnect the Power Cord.
3. Open the Front Door and slide out the Element Feeder drawer.
4. Do GP 6.8 to remove the Supply Spool.
5. Remove the Element Feeder Door. Follow procedure REP 1.2 to remove the Element Feeder Door.
6. Remove the Rear Cover by removing the M4 Screws (8)

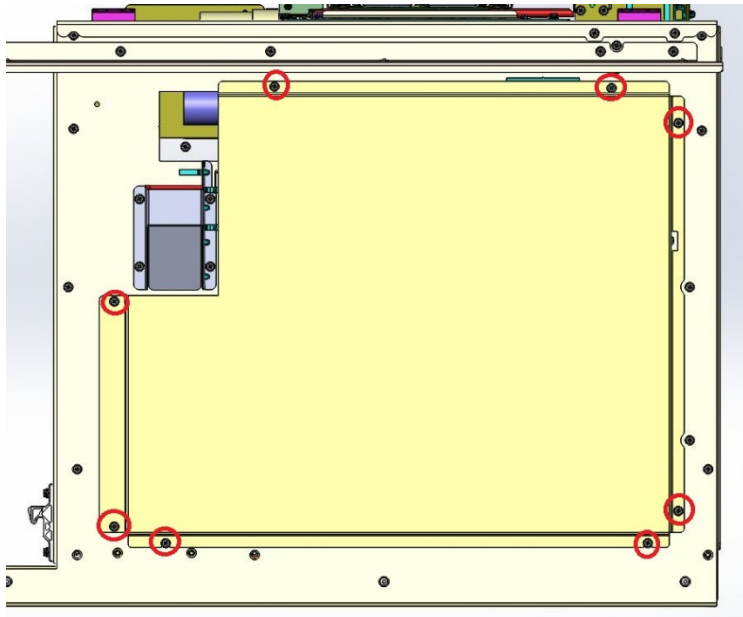

7. Disconnect the Motor Cable from the Stepper Motor Driver.



8. Do REP 3.12 [Element Sprocket Nose Replacement](#) to remove the Element Sprocket Nose Assembly.
9. While supporting the motor with your free hand, remove the M3 Screws (4) holding the stepper motor.

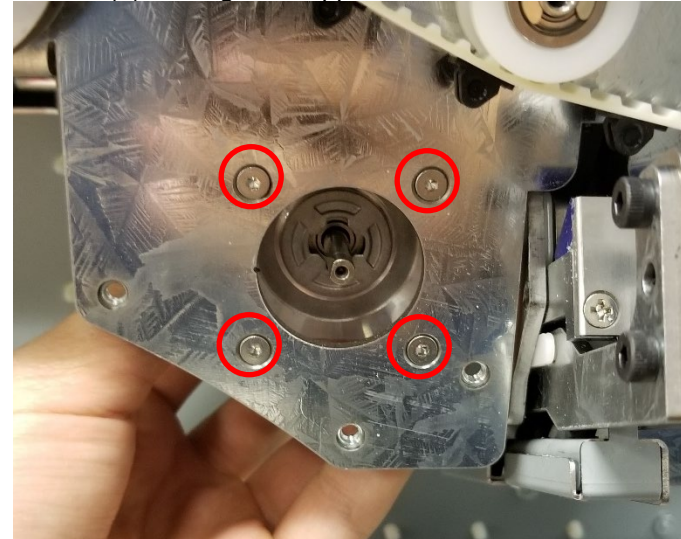

#### Installation Procedure

1. Reverse the steps in the Removal Procedure.
2. Connect the Power Cord.
3. Power ON the eWire.

### REP 3.9 Spool Rewind Drive Assembly Replacement, M8

#### PARTS LIST ON PL 5.8

Use this procedure to remove and install the Spool Rewind Drive Assembly. The Spool Rewind Motor (M8) and Spool Rewind Belt are included as part of this assembly.

#### WARNING

**Do not perform repair activities with the power on or electrical power supplied to the machine. Some machine components contain dangerous electrical voltages that can result in electrical shock and possible serious injury. See Section 0, page vi for other languages.**

#### Removal Procedure

1. Switch power OFF to eWire.
2. Disconnect the Power Cord.
3. Open the Front Door and slide out the Element Feeder drawer.
4. Do GP 6.8 to remove the Supply Spool.
5. Remove the Element Feeder Door. Follow procedure REP 1.2 to remove the Element Feeder Door.
6. Remove the Element Feeder Rear Cover by removing the M4 Screws (8). The bottom screws can be used as a pivot to aid removal.

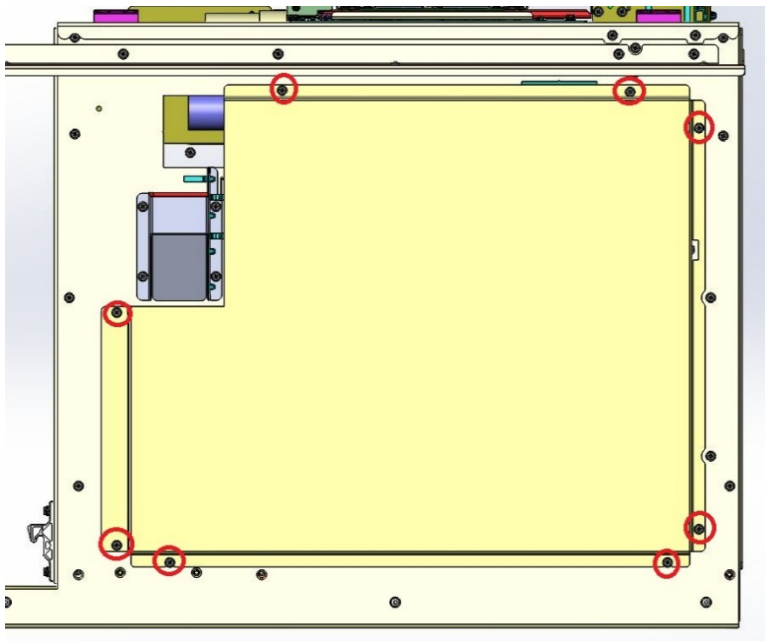

7. Loosen the M4 Screws on the Belt Tensioner and slide the Tensioner forward to relieve tension on the Spool Rewind Belt.



8. Slide the Belt off of the Drive Pulley.



9. Do GP 6.13 to remove the Supply Spool, Rewind Spool, Spool Detect Cover and Rear Baffle.
10. Follow REP 3.4 and REP 3.5 to disconnect the Element Detect and Spool Empty sensors.
11. Remove the M4 Screws (8) securing the Spindle Frame Assembly to the Element Feeder. Carefully tilt the Spindle Frame Assembly forward to remove it from the Element Feeder Body.

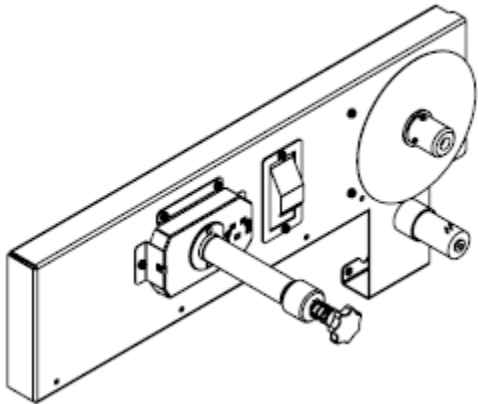
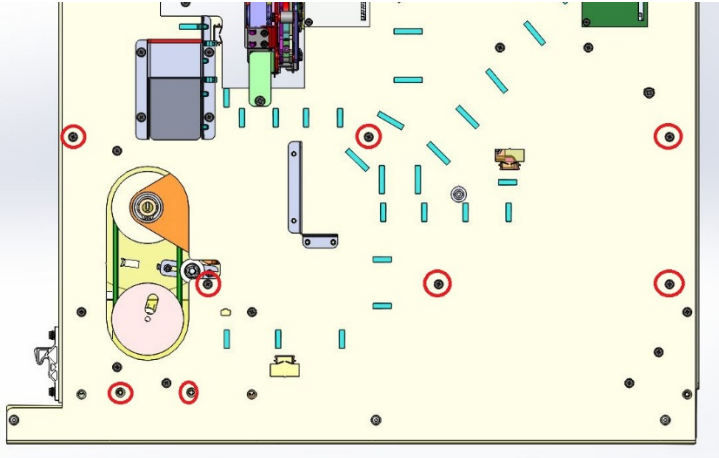

Spindle Frame Assembly

12. Disconnect the Motor Cable at the header.



13. Remove the Retaining Ring and Washer from rear side of the Rewind Hub.



14. Loosen the M4 Set Screw securing the Idler Pulley to the Rewind Spool Shaft, and slide the Idler Pulley off of the Shaft.



15. Remove the M3 Screw securing the Liner Tube to the Spool Rewind Hub.

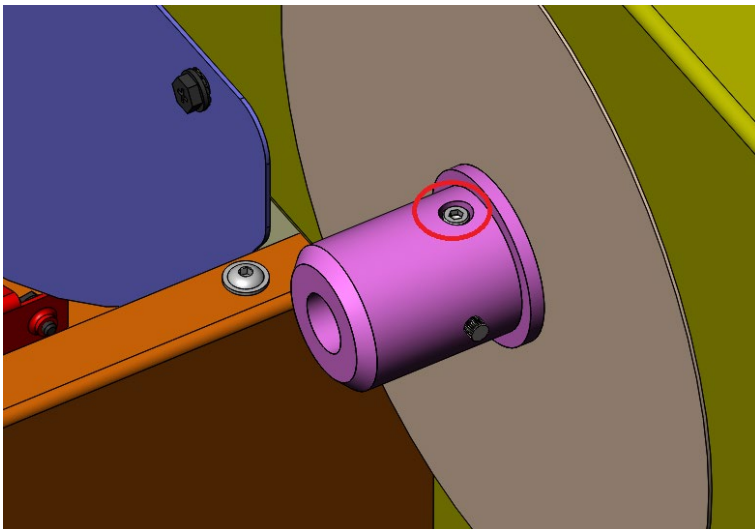

16. Remove the retaining ring from the Spool Rewind Hub and slide the flange off of the shaft.

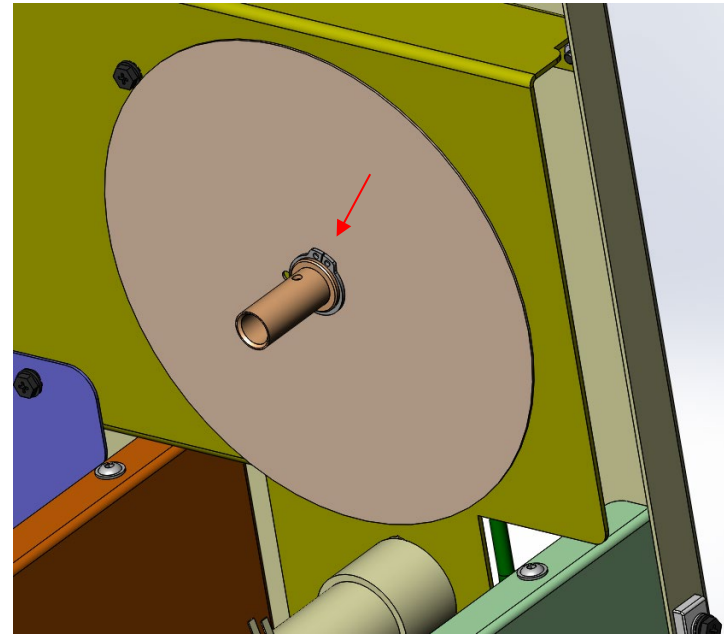

17. Remove the flanged bearings and slide the Rewind Hub out of the assembly. Slide the Idler Pulley off of the Rewind Hub from the opposite side of the assembly and remove it.

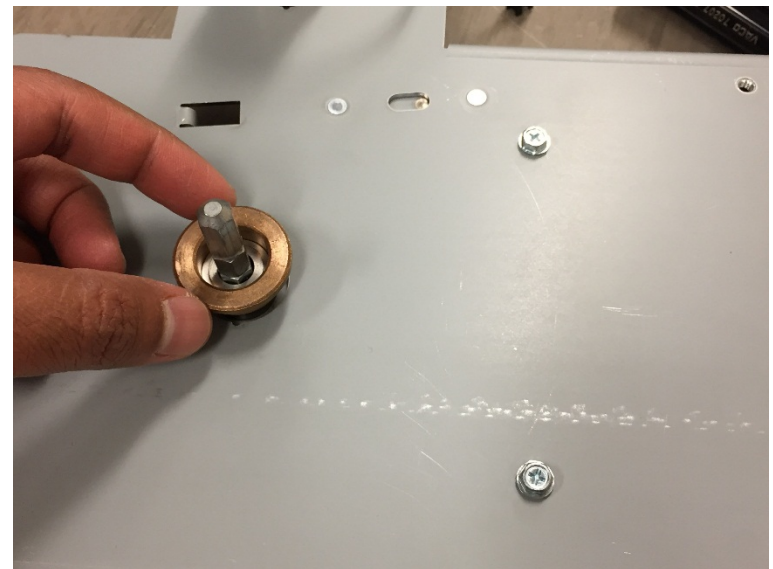

18. Loosen the M4 Set Screw securing the Drive Pulley to the Motor shaft and remove the Drive Pulley



### Installation Procedure

1. Reverse the steps found in the Removal Procedure.
2. Connect the Power Cord.
3. Power ON the eWire.

19. Remove the Spool Rewind Motor M8 by removing the #4-40 Screws securing it to the Element Feeder.



## REP 3.10 Element Feed Track Assembly Replacement

### PARTS LIST ON PL 5.9

Use this procedure to remove and install the Element Feed Track Assembly 7716577.

#### Removal Procedure

#### **WARNING**

**Do not perform repair activities with the power on or electrical power supplied to the machine. Some machine components contain dangerous electrical voltages that can result in electrical shock and possible serious injury. See Section 0, page vi for other languages.**

1. Switch power OFF to eWire.
2. Disconnect the Power Cord.
3. Open the Front Door and slide out the Element Feeder drawer.
4. Do REP 3.3 [Element Belt Home Sensor Replacement – S25](#) to remove the Belt Detect Sensor Bracket and the S22 Receiver PBC.

#### Installation Procedure

1. Reverse the steps in the Removal Procedure.
2. Connect the Power Cord.
3. Power ON the eWire.

## REP 3.11 Element Feed Belt Idler Replacement

### PARTS LIST ON PL 5.9

Use this procedure to remove and install the Element Feed Belt Idler.

#### Removal Procedure

#### **WARNING**

**Do not perform repair activities with the power on or electrical power supplied to the machine. Some machine components contain dangerous electrical voltages that can result in electrical shock and possible serious injury. See Section 0, page vi for other languages.**

1. Switch power OFF to eWire.
2. Disconnect the Power Cord.
3. Open the Front Door and slide out the Element Feeder drawer.
4. Do GP 6.8 to remove the Supply Spool
5. Do REP 3.15 [Element Transfer Module Replacement](#) to remove the Element Transfer Module.
6. Remove the M4 Screw holding the Idler Assembly.

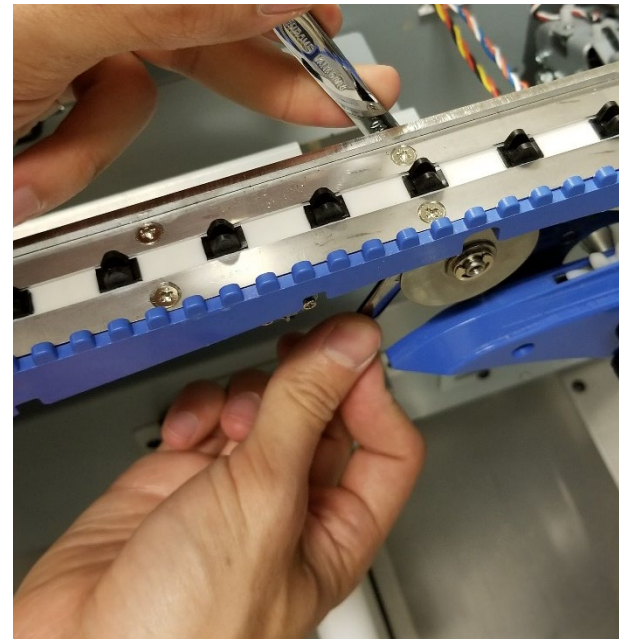

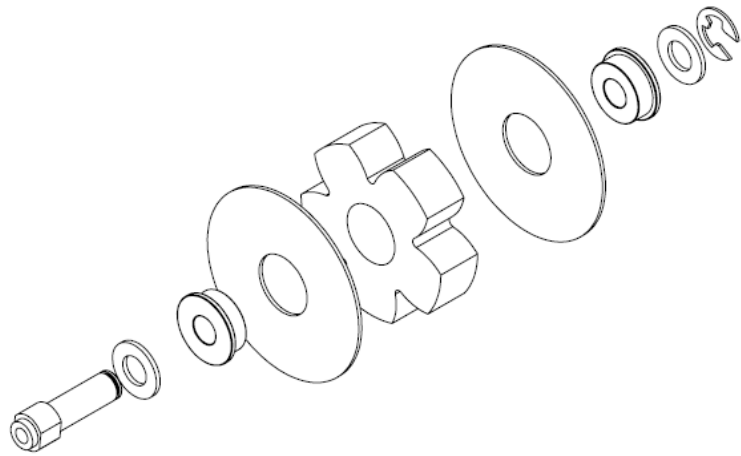

**Idler Assembly**

#### **Installation Procedure**

1. Reverse the steps in the Removal Procedure. Take care that the Element Feed Belt teeth are meshing properly with the Idler Pulley during assembly.
2. Connect the Power Cord.
3. Power ON the eWire.

#### **REP 3.12 Element Sprocket Nose Replacement**

##### **PARTS LIST ON PL 5.9**

Use this procedure to remove and install the Element Sprocket Nose Assembly.

#### **WARNING**

**Do not perform repair activities with the power on or electrical power supplied to the machine. Some machine components contain dangerous electrical voltages that can result in electrical shock and possible serious injury. See Section 0, page vi for other languages.**

#### **Removal Procedure**

1. Switch power OFF to eWire.
2. Disconnect the Power Cord.
3. Open the Front Door and slide out the Element Feeder drawer.
4. Do GP 6.8 to remove the Supply Spool.
5. Remove the M4 Screws (3) holding the Element Feeder Belt Cover

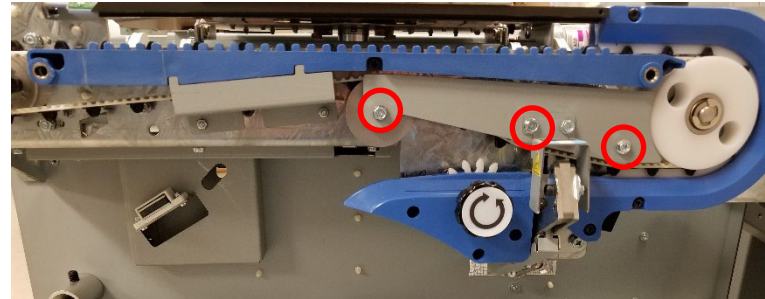

6. Loosen the M4 Set Screw and remove the Element Sprocket Knob.



7. Loosen the M3 Set Screw to allow the Sprocket Feed Shaft to be removed from the stepper motor shaft.

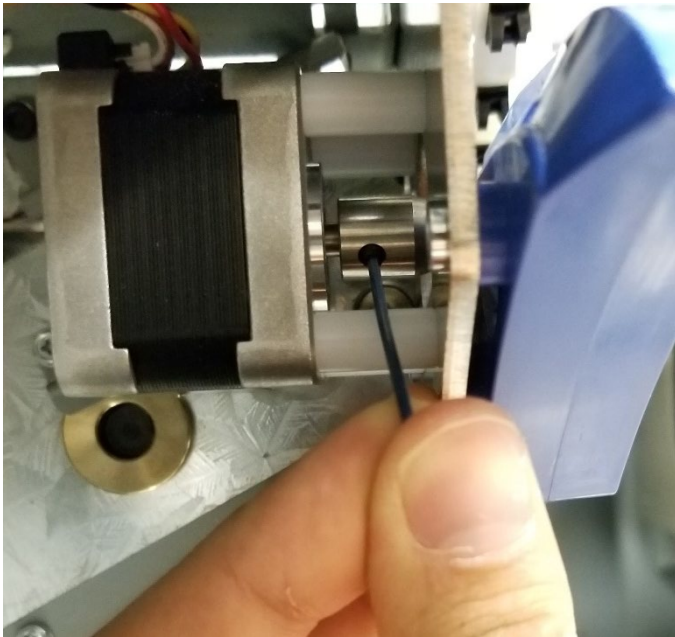

8. Remove the M4 Screws (3) and remove the Element Sprocket Nose Assembly.

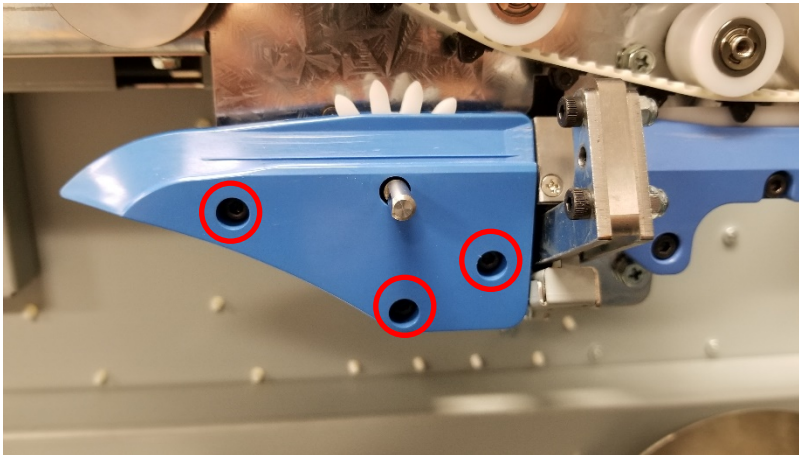

### Installation Procedure

1. Assemble the new Element Sprocket Nose Assembly onto the Element Feeder Drawer as shown. Ensure that the sprocket is seated on the pin.

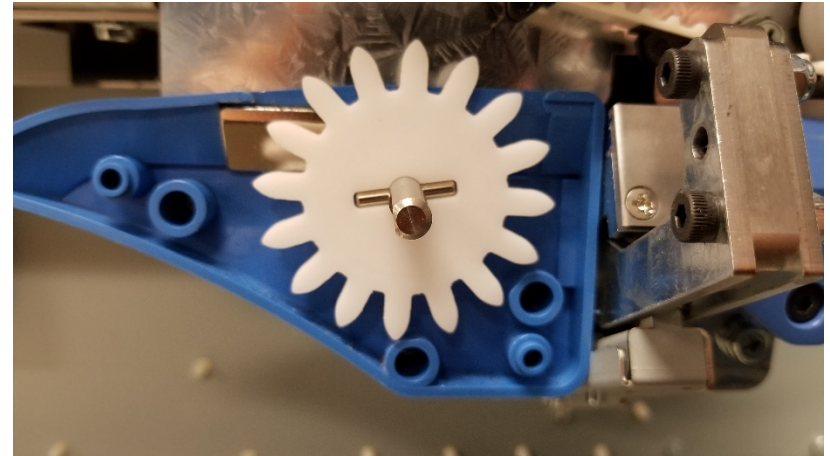

2. Attach the remaining piece of the Element Sprocket Nose Assembly and reverse the steps in the Removal Procedure. **Note:** The M3 Set Screw on the Sprocket Feed Shaft must align with the flat on the stepper motor shaft.
3. Verify that the sprocket moves when turning the Element Sprocket Knob. If the sprocket does not turn, reset the sprocket on the pin as shown in Step 1.
4. Connect the Power Cord.
5. Power ON the eWire.



## REP 3.13 Element Engagement Guide Replacement

### PARTS LIST ON PL 5.9

Use this procedure to remove and install the Element Engagement Guide Assembly.

#### WARNING

**Do not perform repair activities with the power on or electrical power supplied to the machine. Some machine components contain dangerous electrical voltages that can result in electrical shock and possible serious injury. See Section 0, page vi for other languages.**

#### Removal Procedure

1. Switch power OFF to eWire.
2. Disconnect the Power Cord.
3. Open the Front Door and Slide the Element Feeder out.
4. Remove the M4 Screws (4) securing the Element Engagement Guide Assembly to the Element Feeder.

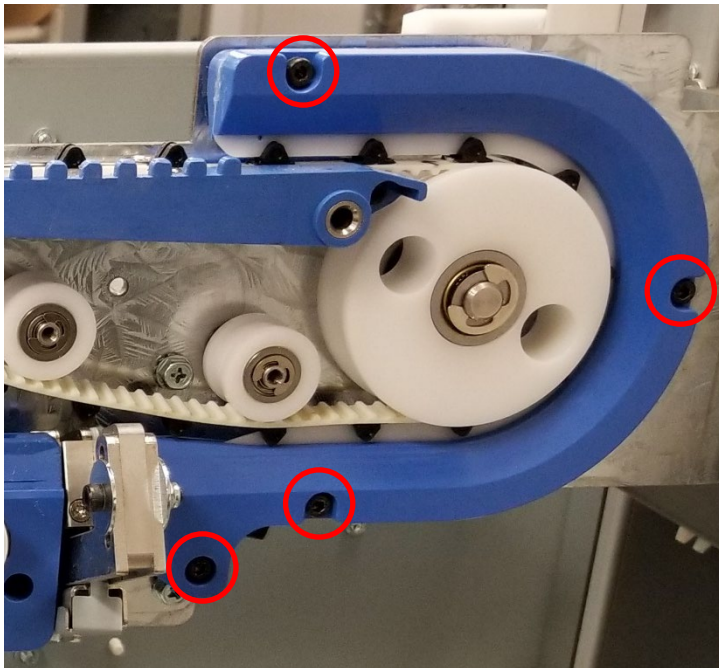

5. Slide the Element Engagement Guide Assembly towards the back of the machine to remove it. Take care not to damage the Feeder Belt teeth. The middle plate on the Element Engagement Guide runs in the center gap of the Belt Teeth. Inspect the components of Element Engagement Guide Assembly for damage. Procure replacement parts if necessary.

#### Installation Procedure

1. Reverse the steps in the Removal Procedure, sliding the Element Engagement Guide Assembly onto the Element Feeder Belt from the rear. Take care to align the center plate of the Element Engagement Guide Assembly with the gaps in the teeth of the Element Feeder Belt.

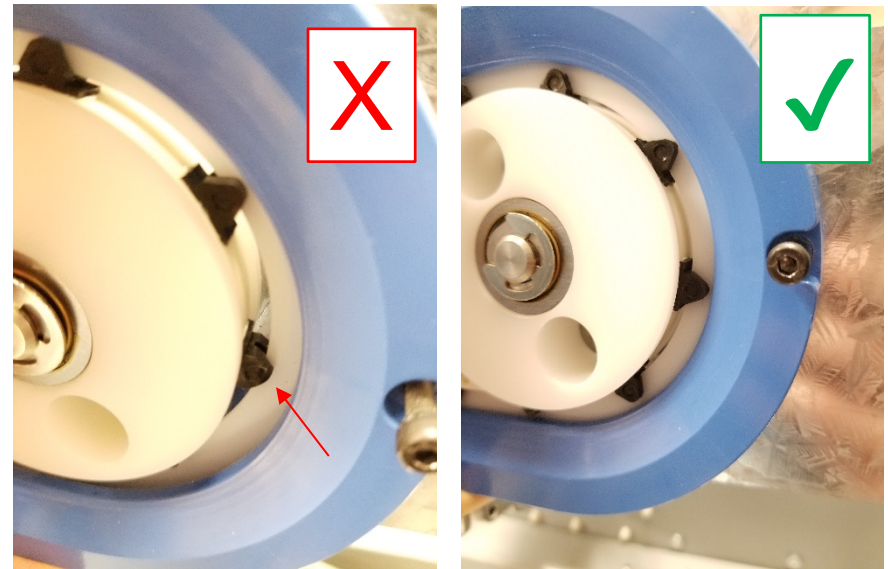

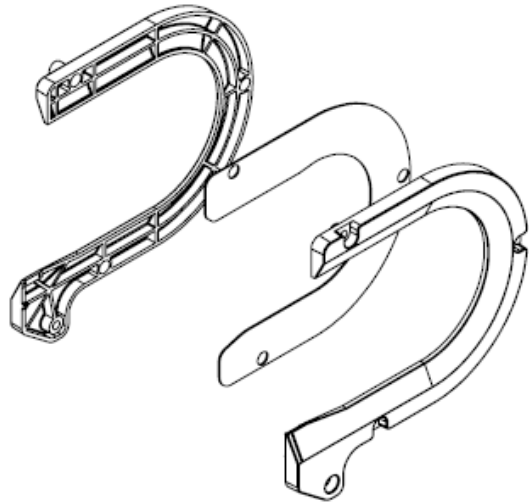

**Element Engagement Guide Assembly**

2. Connect the Power Cord.
3. Power ON the eWire.

### REP 3.14 Knife Module Replacement PARTS LIST ON PL 5.11

Use this procedure to remove and install the Knife Module

#### **WARNING**

**Do not perform repair activities with the power on or electrical power supplied to the machine. Some machine components contain dangerous electrical voltages that can result in electrical shock and possible serious injury. See Section 0, page vi for other languages.**

#### **Removal Procedure**

1. Switch power OFF to eWire.
2. Disconnect the Power Cord.  
**NOTE: Handle the Knife Module carefully and keep fingers clear of the knife blade.**
3. Open the Front Door and slide out the Element Feeder drawer.
4. Do GP 6.8 to remove the Supply Spool.
5. Remove the Element Feeder Back Cover by removing the M4 Screws (8).

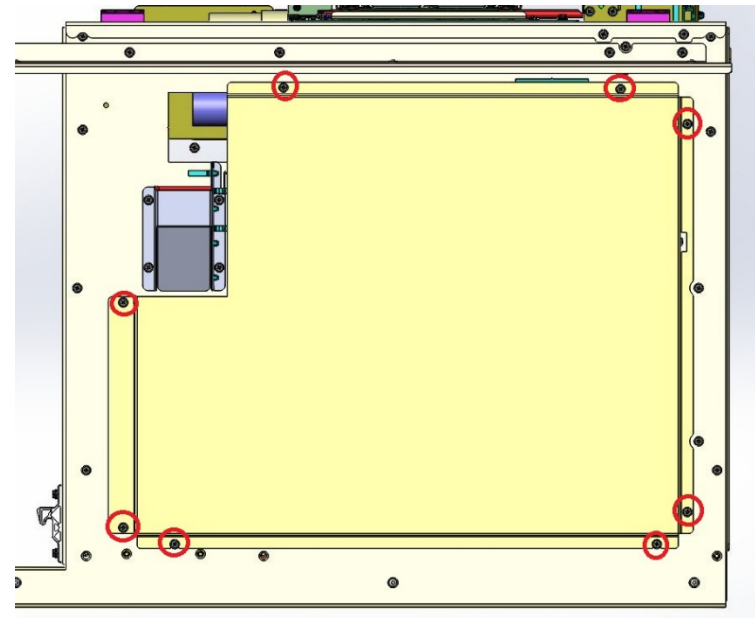

6. Remove the Element Feeder Belt Cover by removing the M4 Screws (3)

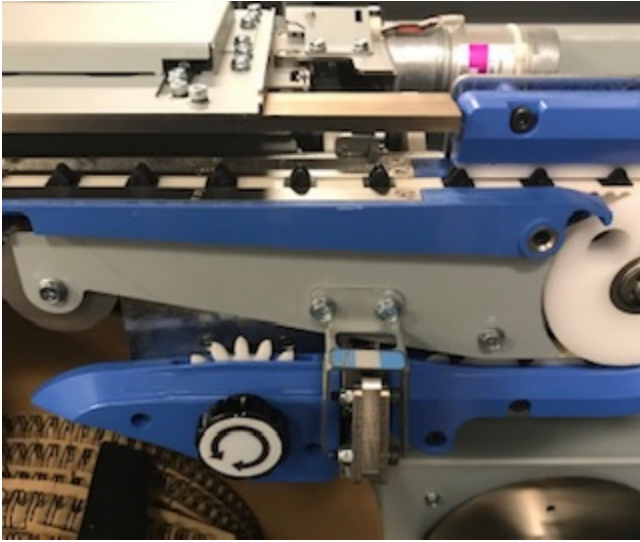

7. Unplug the Knife Module harness at the wire header.

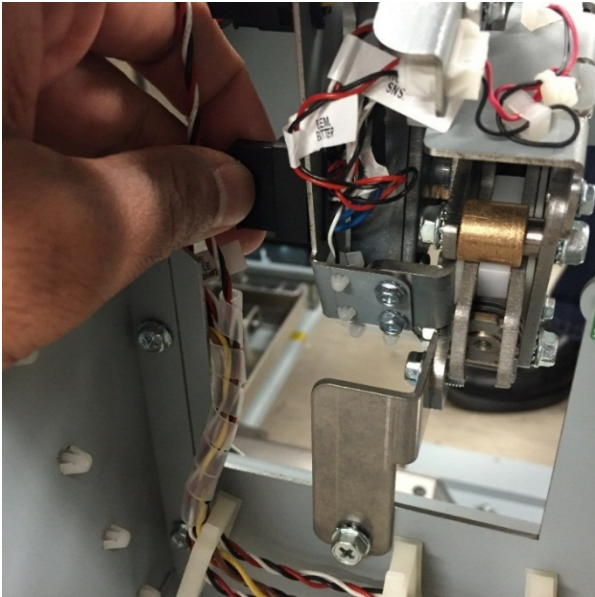

8. Do REP 3.14.3 to remove the knife blade and anvil.
9. Remove the M5 Screw securing the rear of the Knife Module.

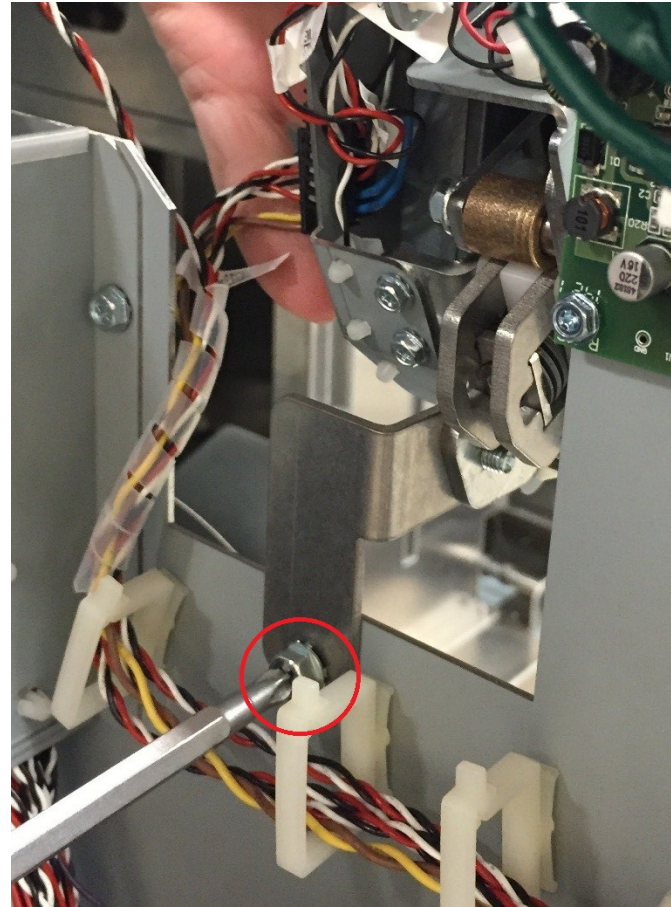

10. While supporting the sub-assembly, remove the M5 Screws (2) securing the front of the Knife Module and carefully remove the Knife Module from the Element Feeder.

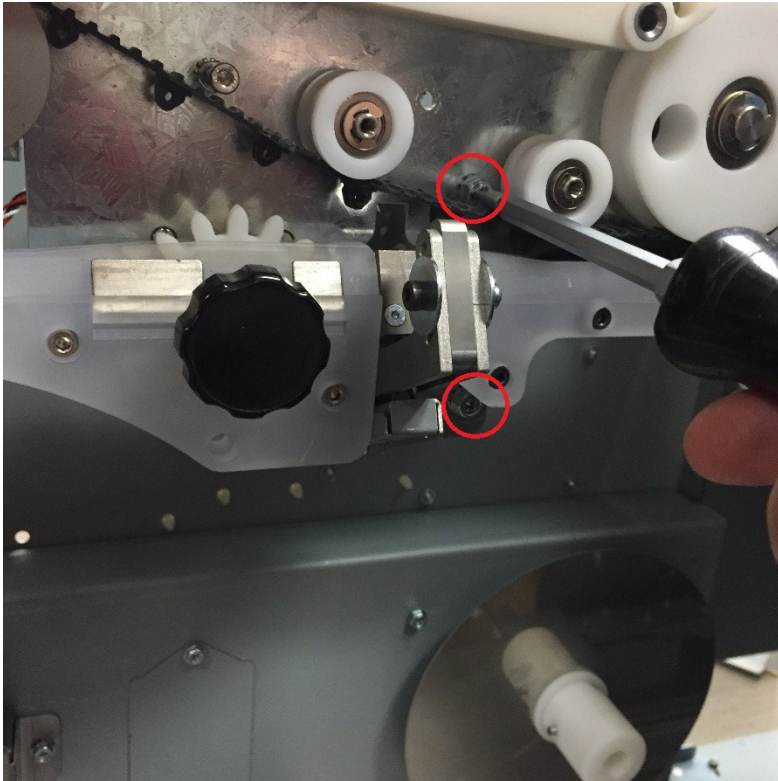

### Installation Procedure

1. Carefully slide the new Knife Module into position on the Element Feeder. Line up the M5 screw holes with the appropriate threads on the frame.
2. Secure the new Knife Module by tightening the M5 Screws (2 front, 1 back).
3. Connect the Knife cable at the header.
4. Do REP 3.14.3 to install the knife blade.
5. Replace the Element Feeder Back Cover by Securing the M4 Screws (8). The bottom screws can be used as a support to help position the cover.
6. Do GP 6.7 to replace the Element Spool.
7. Connect the Power Cord.
8. Power ON the eWire.

### REP 3.14.1 Element Detect at Knife Sensor Replacement S21

#### PARTS LIST ON PL 5.11

Use this procedure to remove and install the Sensor for Element Detect at Knife, S21.

#### WARNING

Do not perform repair activities with the power on or electrical power supplied to the machine. Some machine components contain dangerous electrical voltages that can result in electrical shock and possible serious injury. See Section 0, page vi for other languages.

#### Removal Procedure

1. Switch power OFF to eWire.
2. Disconnect the Power Cord.
3. Do REP 3.15 [Knife Module Replacement](#) to remove the Knife Module
4. Remove the Bottom Cover by removing the M3 Screws (2)

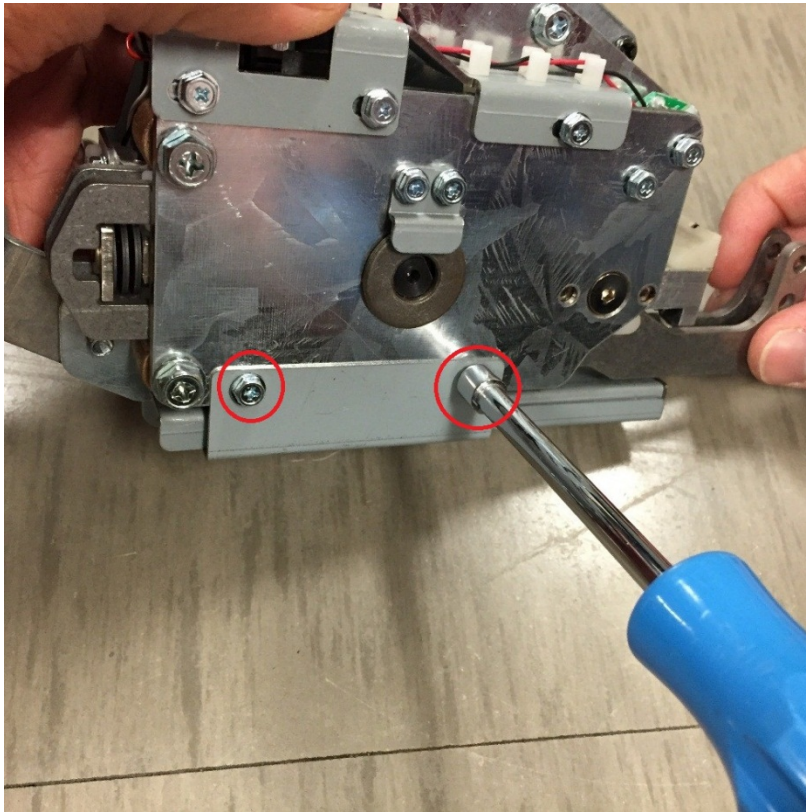

5. Remove the sensor wires connector at the header.

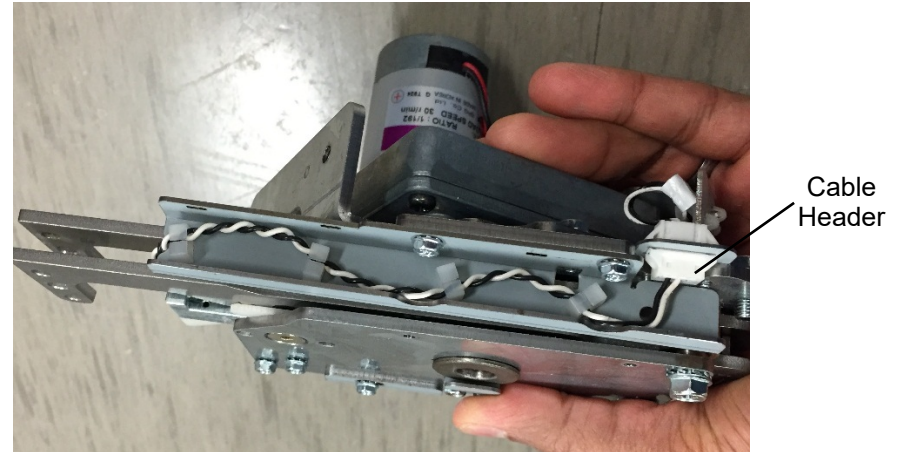

6. Remove the sensor cable Wireway by removing the 2 fasteners below



7. Remove the M2 Screw from the underside of the Sensor Mounting Block.

8. Remove the Sensor Mounting Block by pulling up on the block. Remove the Sensor by sliding it out of the Sensor Mounting Block.



9. Remove the Upper Cable Cover by removing the M3 Screws (2).

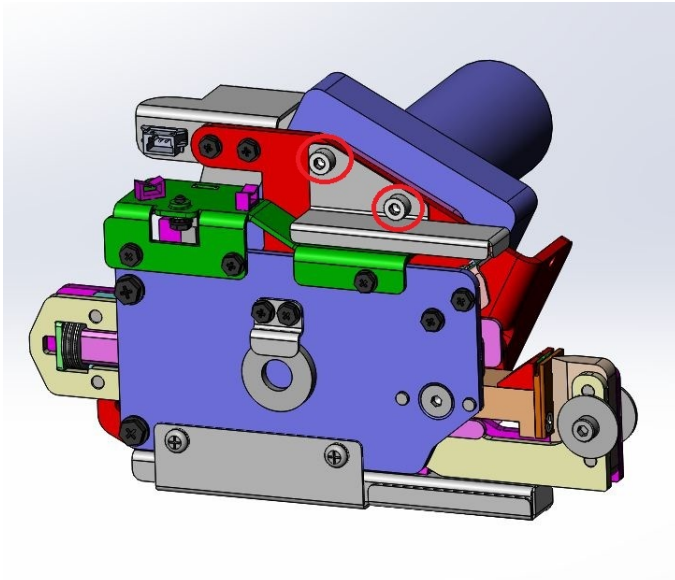

10. Disconnect the Emitter Cable at the cable header.

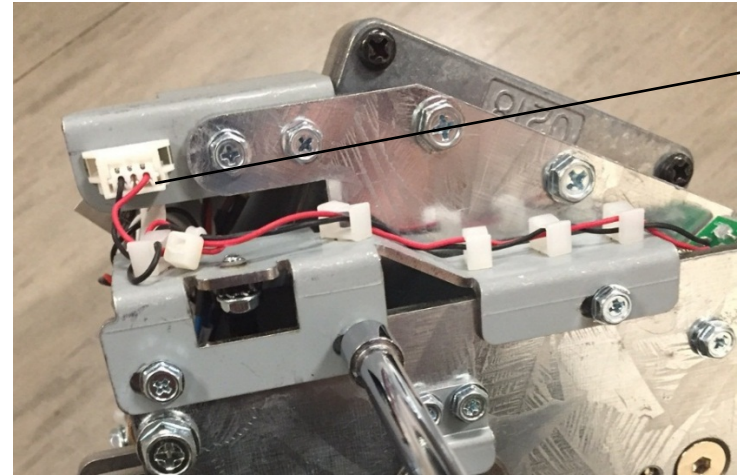

Emitter Cable Connection

11. Remove the M3 mounting Screws from the Emitter PCB and remove the Emitter PCB.

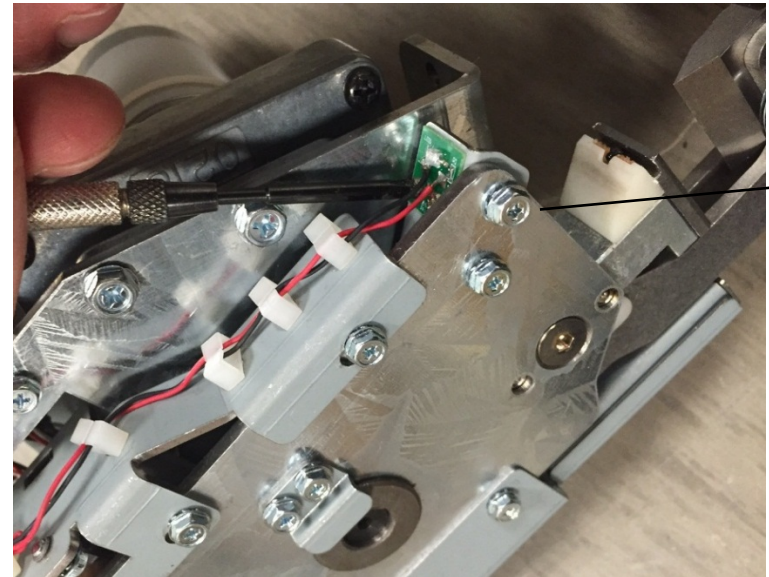

Emitter Mounting Screws

12. Remove the M2 mounting Screws from the Emitter PCB and remove the Emitter PCB.

## Installation Procedure

1. Align the new Emitter PCB on the mounting bracket and secure it using the M2 Screws.
2. Connect the Emitter cable at the header and run the cable through the wire clamps.
3. Attach the Upper Wire Cover using the M3 Screws (2).
4. Slide the new Receiver PCB into the Sensor Housing Assembly.
5. Run the Sensor cable through the opening and slide the Sensor Housing Assembly into place. Secure the Sensor Housing Assembly using the M2 Screw.
6. Install the Cable Conduit by tightening the M3 Screws (2).
7. Run the Receiver Cable through the cable clamps on the Cable Conduit and connect it at the Cable Header.
8. Install the Lower Cable Cover using the M3 Screws (2).
9. Do REP 3.15 [Knife Module Replacement](#) to install the Knife Module.
10. Connect the Power Cord.
11. Power ON the eWire.

## REP 3.14.2 Knife Home Sensor Replacement S23

### PARTS LIST ON PL 5.11

Use this procedure to remove and install the Knife Home Sensor

### WARNING

**Do not perform repair activities with the power on or electrical power supplied to the machine. Some machine components contain dangerous electrical voltages that can result in electrical shock and possible serious injury. See Section 0, page vi for other languages.**

### Removal Procedure

1. Switch power OFF to eWire.
2. Disconnect the Power Cord.
3. Do REP 3.15 [Knife Module Replacement](#) to remove the Knife Module
4. Remove the Upper Cable Cover by removing the M3 Screws (2).
5. Remove the Sensor Bracket by removing the M3 Screws (3).

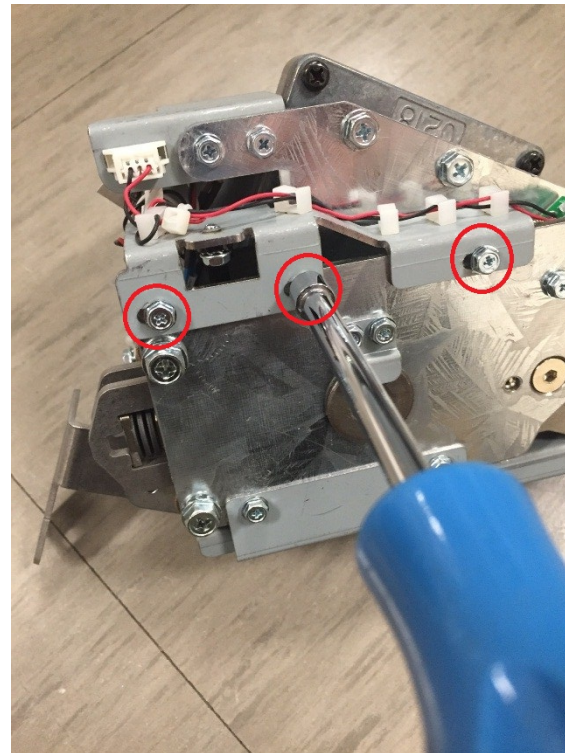

6. Disconnect the Sensor Cable from the Sensor.
7. Remove the M3 Screw securing the sensor and remove the old Sensor.

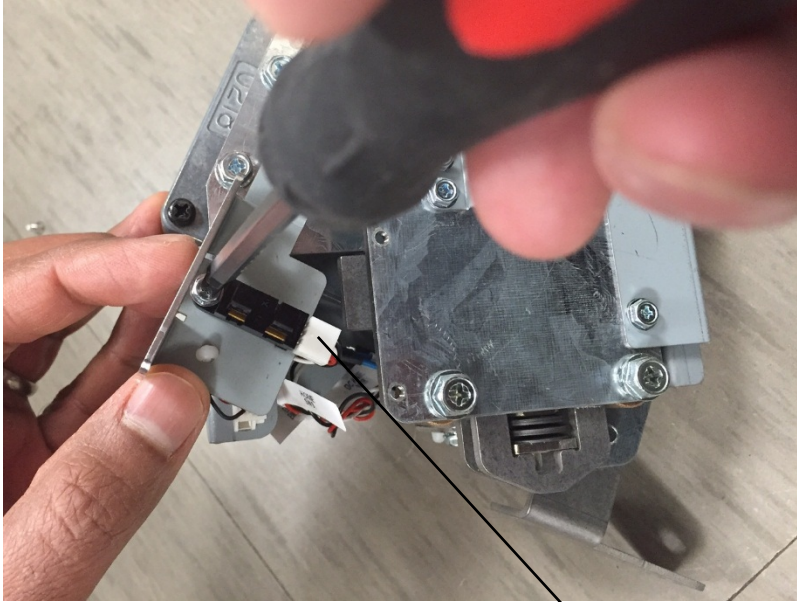

Sensor Cable  
Connection

### Installation Procedure

1. Align the new Sensor on the Sensor Bracket using the tab. Secure the new Sensor to the Sensor Bracket using the M3 Screw.
2. Connect the Sensor Cable to the Knife Home Sensor.
3. Secure the Sensor Bracket by using the M3 Screws (3).
4. Secure the Upper Cable Cover by tightening the M3 Screws (2).
5. Do REP 3.15 [Knife Module Replacement](#) to install the Knife Module.
6. Connect the Power Cord.
7. Power ON the eWire.



### REP 3.14.3 Knife Anvil and Blade Replacement

#### PARTS LIST ON PL 5.11

Use this procedure to remove and install the Knife Anvil and Blade

#### **WARNING**

**Do not perform repair activities with the power on or electrical power supplied to the machine. Some machine components contain dangerous electrical voltages that can result in electrical shock and possible serious injury. See Section 0, page vi for other languages.**

#### Removal Procedure

1. Switch power OFF to eWire.
2. Disconnect the Power Cord.  
**NOTE: Handle the Knife Module carefully and keep fingers clear of the knife blade edge.**
3. Remove the M4 Screw and Nuts (2) securing the Knife Blade to the Knife Module Arm. Set the fasteners aside for re-use.



4. Remove the Knife Blade.

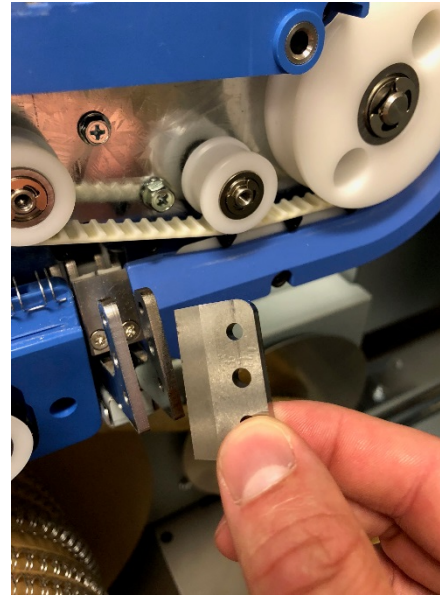

5. Remove the M3 Flat Head Screws securing the Knife Anvil.



6. Remove the Knife Anvil

## Installation Procedure

1. Reverse the steps in the Removal Procedure. Do not fully tighten the screws securing the Knife to the frame.
2. Do ADJ 1.18 to adjust the Knife position to be parallel to the Anvil.
3. Connect the Power Cord.
4. Power ON the eWire.

## REP 3.15 Element Transfer Module Replacement

### PARTS LIST ON PL 5.12

Use this procedure to remove and install the Element Transfer Module, which also carries the Expanding T Module.

### WARNING

**Do not perform repair activities with the power on or electrical power supplied to the machine. Some machine components contain dangerous electrical voltages that can result in electrical shock and possible serious injury. See Section 0, page vi for other languages.**

### Removal Procedure

1. Switch power OFF to the eWire.
2. Disconnect the Power Cord.
3. Open the Front Door and slide out the Element Feeder drawer.
4. Remove the Element Feeder Door. Follow procedure REP 1.2 to remove the Element Feeder Door.
5. Remove the Element Feeder Rear Panel by removing or loosening the M4 Screws (8). The bottom 2 screws can be loosened slightly, but do not remove, to aid in reassembly.

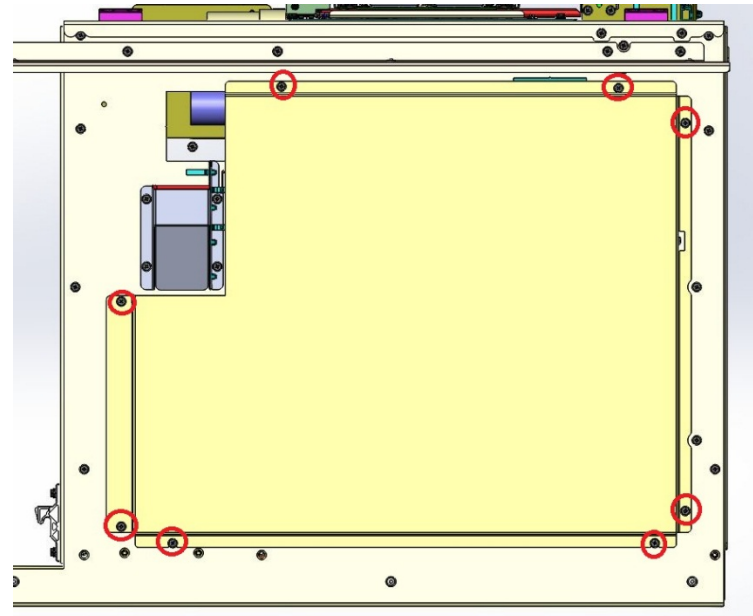

6. Remove the M4 Screws (2) securing the Upper Element Feeder Cover

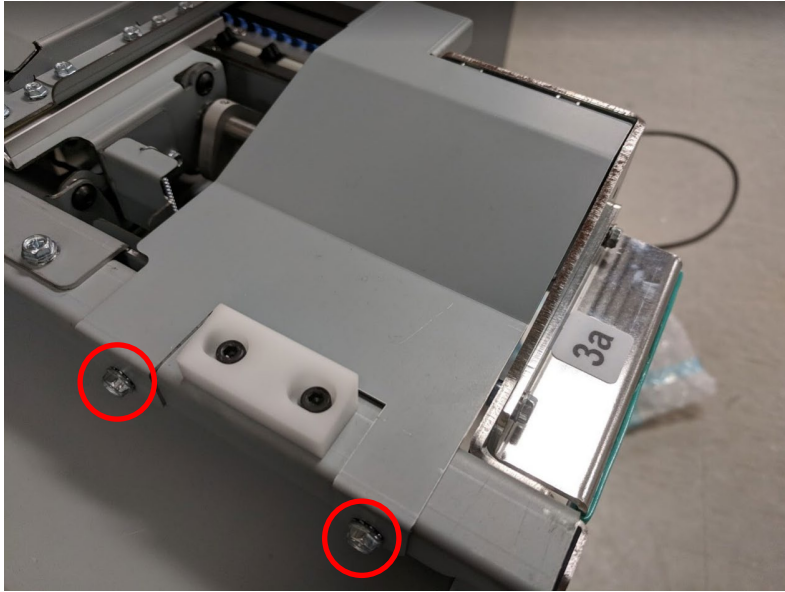

8. Remove the M4 Screws (2) securing the Element Transfer Module from the top.

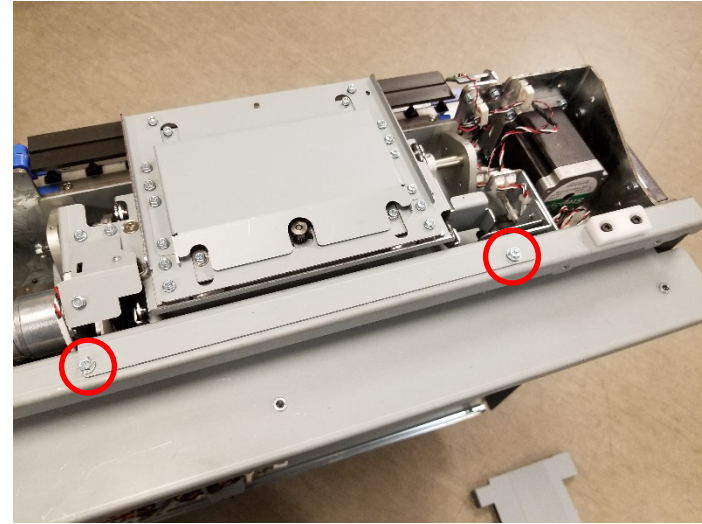

7. Disconnect the cable to the Element Transfer Module at the header.



9. Remove the M4 Screws (3) holding the Element Feeder Belt Cover

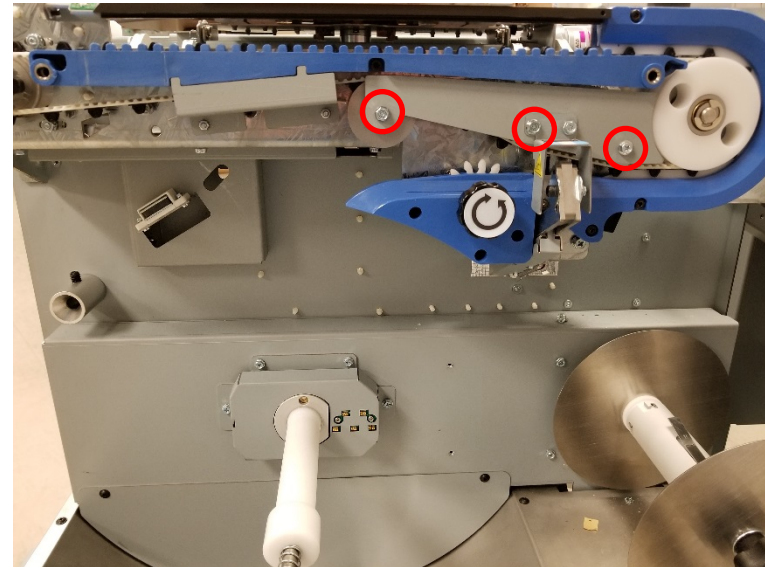

10. Remove the M4 Screws (2) securing the Element Transfer Module from the side. Use the knob to turn the Element Feeder Belt, as needed, to access the screw on the left.

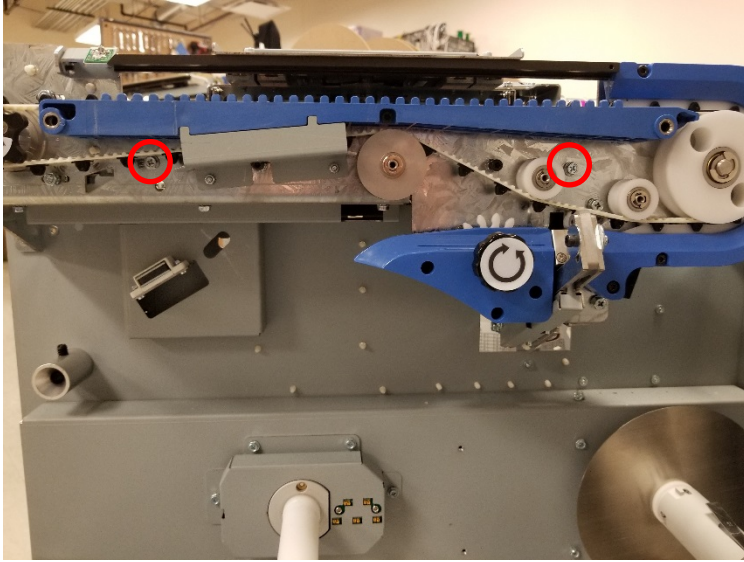

11. Carefully remove the Element Transfer Module by lifting it straight up out of the Element Feeder.

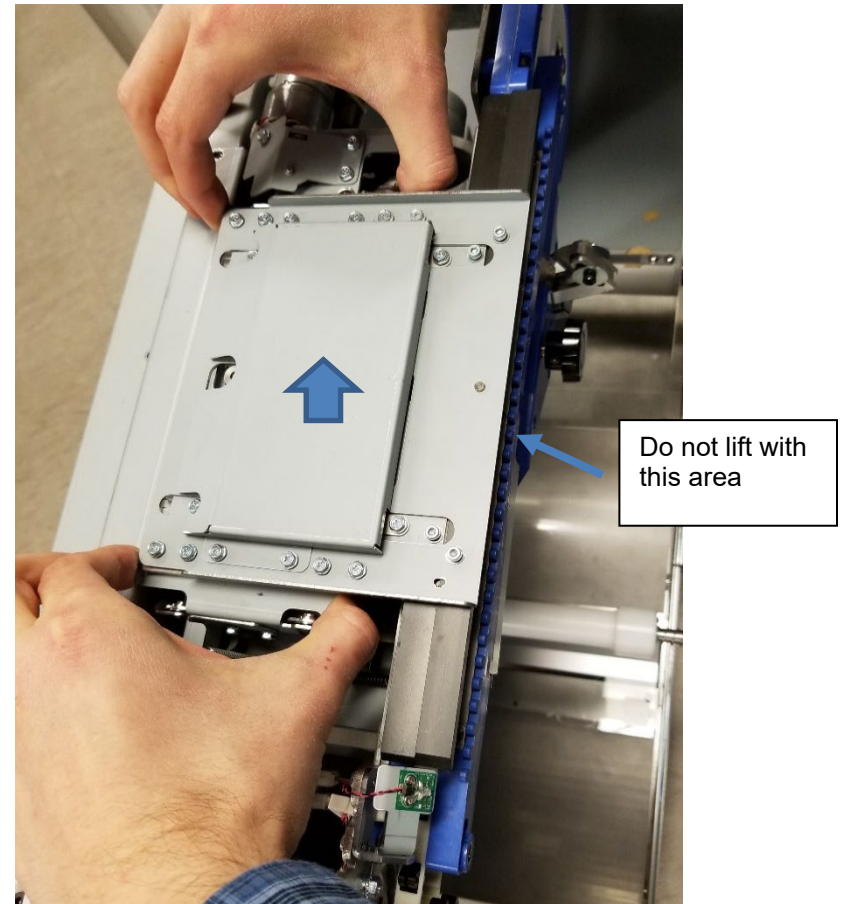

#### Installation Procedure

1. Carefully slide the Element Transfer Module into position on the Element Feeder.
2. Perform, in reverse order, the steps in the removal procedure. **NOTE:** It is very important to install and tighten the M4 screws (2) on the side of the Element Transfer Module before installing the M4 screws (2) on the top.
3. Connect the Power Cord.
4. Power ON the eWire.

### REP 3.15.1 Element Pushover Encoder Sensor Replacement S31

#### PARTS LIST ON PL 5.12

Use this procedure to remove and install the Pushover Encoder Sensor on the Element Transfer Module.

#### WARNING

**Do not perform repair activities with the power on or electrical power supplied to the machine. Some machine components contain dangerous electrical voltages that can result in electrical shock and possible serious injury. See Section 0, page vi for other languages.**

#### Removal Procedure

1. Switch power OFF to eWire.
2. Disconnect the Power Cord. Disconnect the Sensor Cable from the Pushover Encoder Sensor.
3. Remove the Encoder Sensor Bracket by removing the M3 Screws (2).

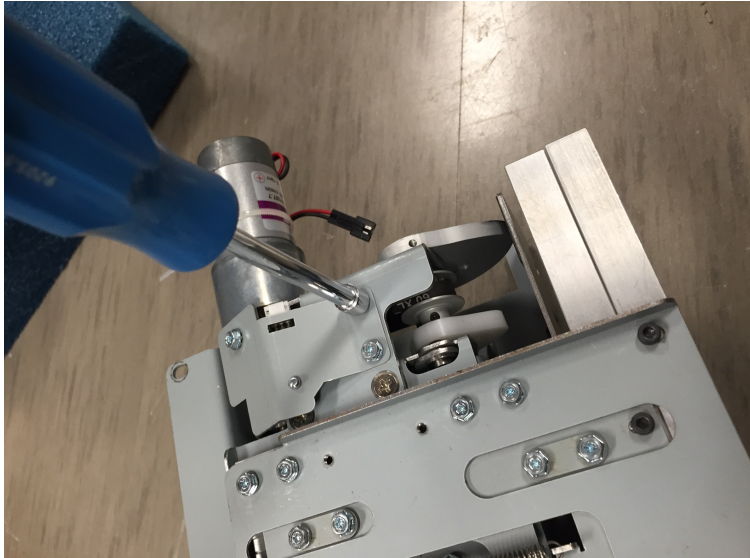

4. Remove the old sensor by removing the M3 Screw.

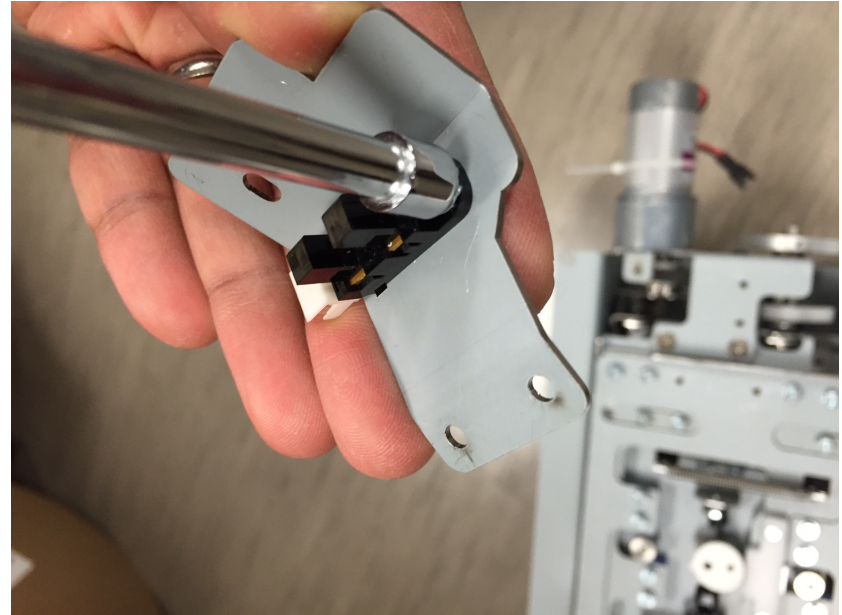

#### Installation Procedure

1. Place the new Sensor onto the Encoder Sensor Bracket and align it using the tab. Secure the Sensor using an M3 Screw.
2. Install the Encoder Sensor Bracket.
3. Connect the Power Cord.
4. Power ON the eWire.

### REP 3.15.2 Pushover Home Sensor Replacement S24

#### PARTS LIST ON PL 5.12

Use this procedure to remove and install the Pushover Home Sensor.

#### **WARNING**

**Do not perform repair activities with the power on or electrical power supplied to the machine. Some machine components contain dangerous electrical voltages that can result in electrical shock and possible serious injury. See Section 0, page vi for other languages.**

#### Removal Procedure

1. Switch power OFF to eWire.
2. Disconnect the Power Cord.
3. Do REP 3.15 [Element Transfer Module Replacement](#) to remove the Element Transfer Module.
4. Disconnect the Sensor Cable from the Pushover Home Sensor.
5. Remove the Pushover Home Sensor by removing the M3 Screw. Slide the old Sensor up and out of the machine.

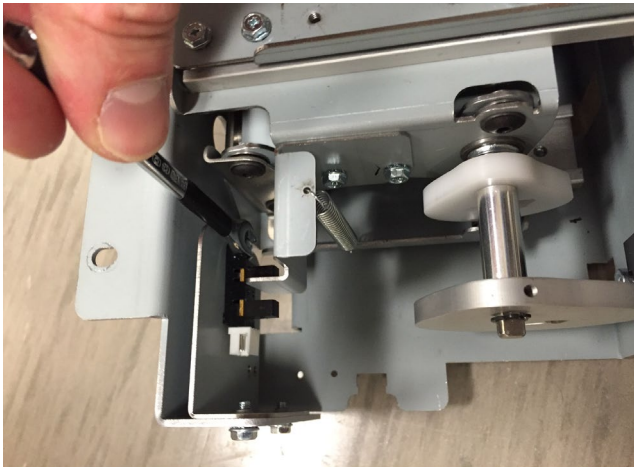

#### Installation Procedure

1. Place the new Sensor onto the mounting bracket and align it using the tab. Secure the Sensor using an M3 Screw.
2. Connect the Sensor Cable to the new Sensor.
3. Do REP 3.15 [Element Transfer Module Replacement](#) to install the Element Transfer Module.
4. Connect the Power Cord.
5. Power ON the eWire.

### REP 3.15.3 Expanding T Home and Out Sensor Replacement S32 & S33

#### PARTS LIST ON PL 5.12

Use this procedure to remove and install the Expanding T Home Sensor S32 and the Expanding T Out Sensor S33. S32 and S33 can be replaced using the same general procedure.

#### **WARNING**

**Do not perform repair activities with the power on or electrical power supplied to the machine. Some machine components contain dangerous electrical voltages that can result in electrical shock and possible serious injury. See Section 0, page vi for other languages.**

#### Removal Procedure

1. Switch power OFF to eWire.
2. Disconnect the Power Cord.
3. Remove the Expanding T top cover by removing the M3 Screws (4).
4. Remove the Sensor by removing the M3 Screw. Carefully pull the sensor up through the opening in the module.

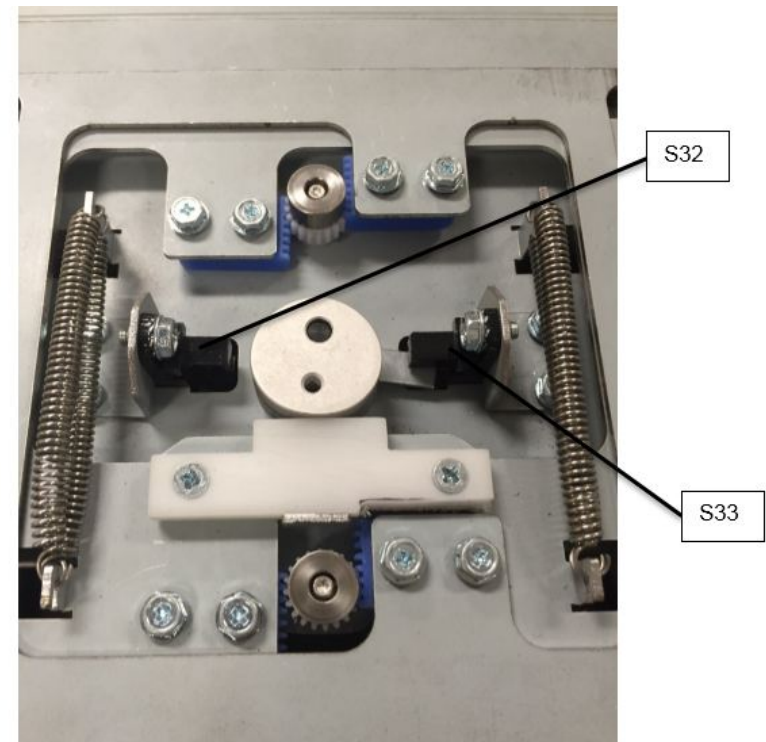

5. Disconnect the Sensor Cable. Secure the cable end with tape so it does not fall back through the opening.
6. Repeat the procedure for the opposing sensor if necessary.

### Installation Procedure

1. Connect the Sensor Cable to the new Sensor.
2. Align the new Sensor with the appropriate mounting bracket using the tab for alignment.
3. Secure the new Sensor using the M3 screw.
4. Repeat the procedure for the opposing sensor if necessary.
5. Replace the Element Transfer Top Cover.
6. Reconnect the Power Cord.
7. Power ON the eWire.

### REP 3.15.4 Element Transfer Rack Replacement

#### PARTS LIST ON PL 5.13

Use this procedure to replace the rack component on the Element Transfer module. There are a total of 4 Rack parts on the Element Transfer Module.

### WARNING

**Do not perform repair activities with the power on or electrical power supplied to the machine. Some machine components contain dangerous electrical voltages that can result in electrical shock and possible serious injury. See Section 0, page vi for other languages.**

#### Removal Procedure

1. Switch power OFF to eWire.
2. Disconnect the Power Cord.
3. Remove the Expanding T top cover by removing the M3 Screws (4).
4. Remove the M3 Screws (2) securing the Rack to the frame.

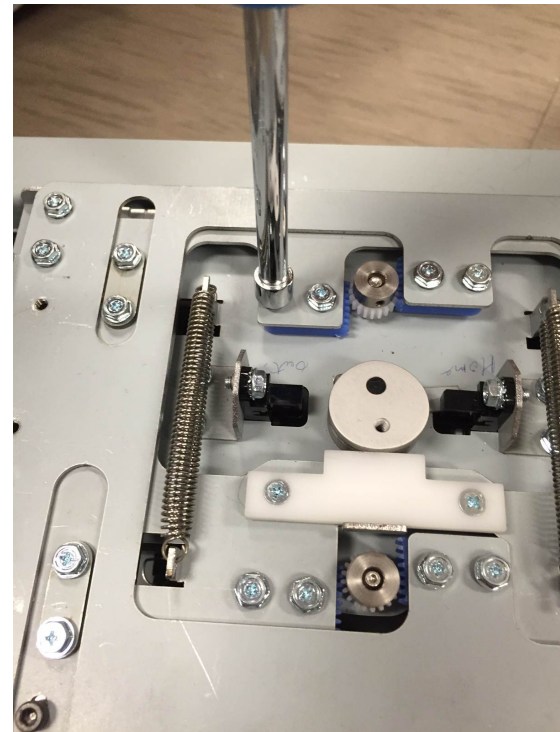

5. Carefully remove the Rack by sliding it out of the module.
6. Repeat the procedure for the remaining Rack parts if necessary.

## Installation Procedure

1. Slide the rack under the mounting plate and align it to the mounting holes on the module.
2. Secure the new Rack using the M3 screws.
3. Repeat the procedure for the remaining Rack Components if necessary.
4. Replace the Element Transfer Top Cover.
5. Connect the Power Cord.
6. Power ON the eWire.

## REP 3.15.5 Horizontal Pushover Cam Replacement

### PARTS LIST ON PL 5.13

Use this procedure to remove and install the Horizontal Pushover Cam. There are 2 Horizontal Cams, which are the larger and outermost Cam components.

### WARNING

**Do not perform repair activities with the power on or electrical power supplied to the machine. Some machine components contain dangerous electrical voltages that can result in electrical shock and possible serious injury. See Section 0, page vi for other languages.**

### Removal Procedure

1. Switch power OFF to eWire.
2. Disconnect the Power Cord.
3. Do REP 3.15 [Element Transfer Module Replacement](#) to remove the Element Transfer Module.
4. Note the orientation of the Horizontal Cam.
5. Remove the retaining ring securing the Horizontal Cam to the shaft.





- Loosen the set screw securing the Cam to the Shaft.

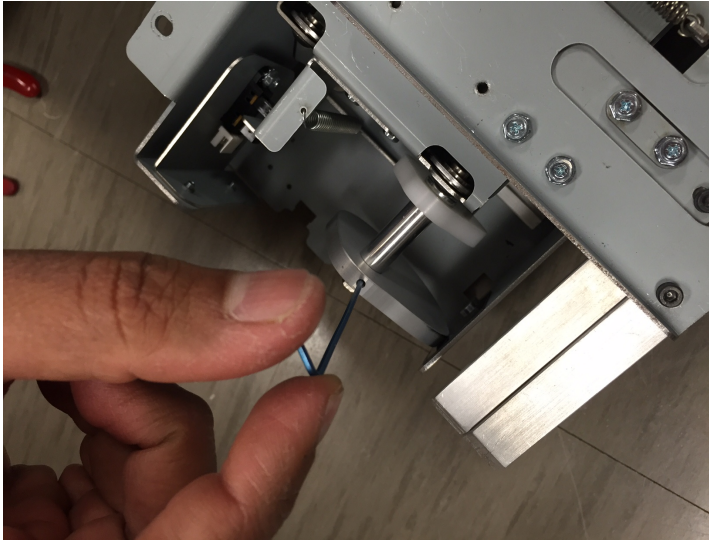

- Slide the Cam and Washers off the shaft.

#### Installation Procedure

- Slide the Washer and the new Cam onto the Shaft.
- Install the Retaining Ring on the end of the Shaft
- Tighten the Set Screw to secure the Cam to the shaft.
- Repeat the procedure for the opposite Cam.
- Do REP 3.15 [Element Transfer Module Replacement](#) to install the Element Transfer Module.
- Connect the Power Cord.
- Power ON the eWire.

#### REP 3.15.6 Vertical Pushover Cam Replacement

##### PARTS LIST ON PL 5.13

Use this procedure to remove and install the Vertical Pushover Cam. There are 2 identical Vertical Cams, one on the drive side of the Expanding T and one on the idler side.

#### WARNING

**Do not perform repair activities with the power on or electrical power supplied to the machine. Some machine components contain dangerous electrical voltages that can result in electrical shock and possible serious injury. See Section 0, page vi for other languages.**

#### Removal Procedure

- Switch power OFF to eWire.
- Disconnect the Power Cord.
- Do REP 3.15 [Element Transfer Module Replacement](#) to remove the Element Transfer Module.
- Do REP 3.15.5 [Horizontal Pushover Cam Replacement](#) to remove the Horizontal Cams.
- Loosen the set screw.
- Remove the idler side Cam by sliding the spacer off the shaft and removing the Cam and Washers.

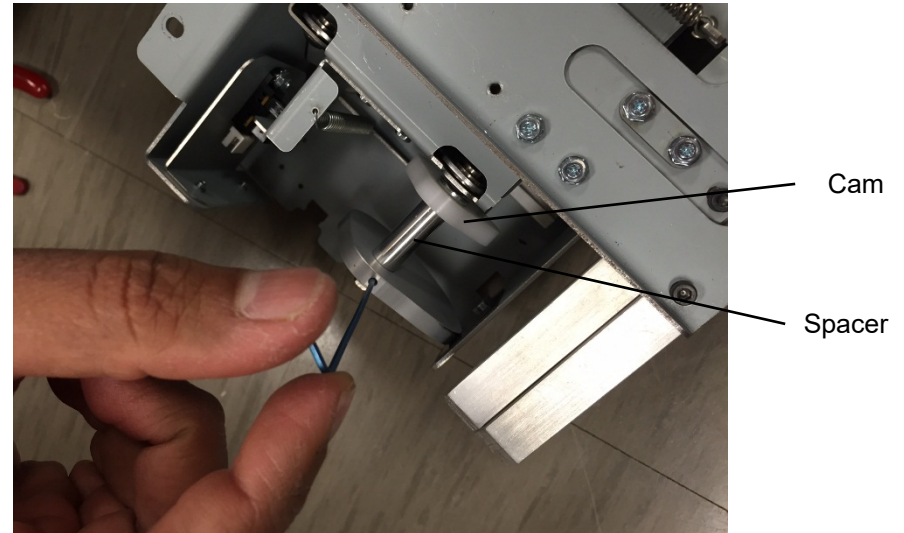

- Do REP 3.15.7 [Expanding T Motor Replacement M13](#) to remove the Pushover Motor Assembly.

- Loosen the M3 Set Screws (2) securing the Drive Shaft Timing Pulley. Slide the Timing Pulley off the Shaft.
- Remove the drive side Cam by sliding it and the washers off of the drive shaft.

#### Installation Procedure

- Slide the Washer and the new Cam onto the Shaft.
- For the idler side cam, install the Spacer and do [REP 3.15.5 Horizontal Pushover Cam Replacement](#) to replace the Horizontal Cam on the idler side.
- For the drive side Cam, slide the new Cam and Washers onto the Drive Shaft. Slide the Timing Pulley onto the drive shaft and secure it using the M3 Set Screws.
- Do [REP 3.15.7 Expanding T Pushover Motor Replacement M12](#) to replace the Expanding T Pushover Motor Bracket Assembly.
- Do [REP 3.15.5 Horizontal Pushover Cam Replacement](#) to replace the Horizontal Cam on the drive side.
- Do [REP 3.15 Element Transfer Module Replacement](#) to install the Element Transfer Module.
- Connect the Power Cord.
- Power ON the eWire.

#### **REP 3.15.7 Pushover Motor Assy Replacement M12**

##### **PARTS LIST ON PL 5.13**

Use this procedure to remove and install the Expanding T Pushover Motor Subassembly.

#### **WARNING**

**Do not perform repair activities with the power on or electrical power supplied to the machine. Some machine components contain dangerous electrical voltages that can result in electrical shock and possible serious injury. See Section 0, page vi for other languages.**

#### **Removal Procedure**

- Switch power OFF to eWire.
- Disconnect the Power Cord.
- Do [REP 3.15 Element Transfer Module Replacement](#) to remove the Element Transfer Module.
- Do [REP 3.15.1 Element Pushover Encoder Sensor Replacement S31](#) to remove the Pushover Encoder Sensor and the Encoder Sensor mounting bracket.
- Do [REP 3.15.5 Horizontal Pushover Cam Replacement](#) to remove the Horizontal Pushover Cam on the drive side.
- Remove the M4 Flat Head Screws securing the top of the Pushover Motor Bracket Assembly.

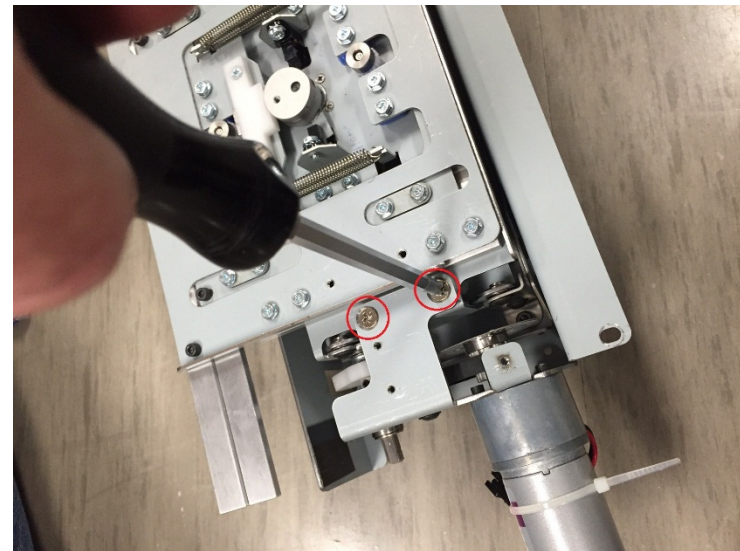

7. Remove the M3 Screw securing the side of the Pushover Motor Bracket Assembly.

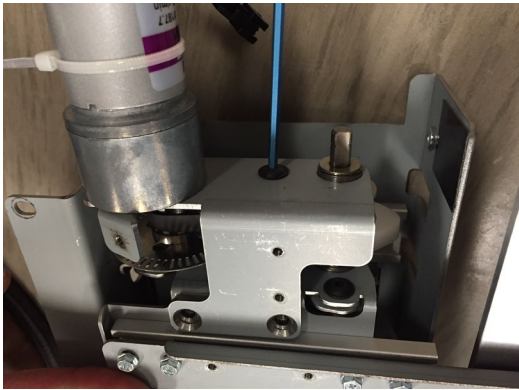

8. Carefully remove the Pushover Motor Bracket Assembly from the frame.
9. Remove the flanged bearing from the drive shaft and remove the Timing Belt from the Motor Drive Pulley. Set the parts aside.

#### Installation Procedure

1. Install the flanged bearing into the opening on the new Pushover Motor Bracket Assembly.
2. Loosely install the Timing Belt around the Timing Pulley.
3. Place the Wave Spring onto the drive shaft.
4. Slide the Flanged Bearing and the Motor Bracket Assembly onto the Drive shaft, and slide the new Motor Bracket Assembly into place.
5. Adjust the Timing Belt to ensure it is seated properly on the Motor and Drive shaft timing pulleys.
6. Secure the Pushover Motor Bracket Assembly using (2) M4 Flat Head Screws on the top and (1) M3 Screw on the side.
7. Do REP 3.15.5 [Horizontal Pushover Cam Replacement](#) to install the Horizontal Pushover Cam.
8. Do REP 3.15.1 [Element Pushover Encoder Sensor Replacement S31](#) to install the Pushover Encoder Sensor and the Encoder Sensor mounting bracket.
9. Do REP 3.15 [Element Transfer Module Replacement](#) to install the Element Transfer Module.
10. Connect the Power Cord.
11. Power ON the eWire.

#### REP 3.15.8 Expanding T Motor Replacement M13

##### PARTS LIST ON PL 5.13

Use this procedure to remove and install the Expanding T Motor, M13

#### WARNING

**Do not perform repair activities with the power on or electrical power supplied to the machine. Some machine components contain dangerous electrical voltages that can result in electrical shock and possible serious injury. See Section 0, page vi for other languages.**

#### Removal Procedure

1. Switch power OFF to eWire.
2. Disconnect the Power Cord.
3. Do REP 3.15 [Element Transfer Module Replacement](#) to remove the Element Transfer Module.
4. Remove the Expanding T top cover by removing the M3 Screws (4).
5. Do REP 3.15.9 [Expanding T Cam Replacement](#) to remove the Expanding T Cam.
6. Remove the M2 Screws securing the Expanding T Motor. Support the motor while removing the Screws so it does not fall.

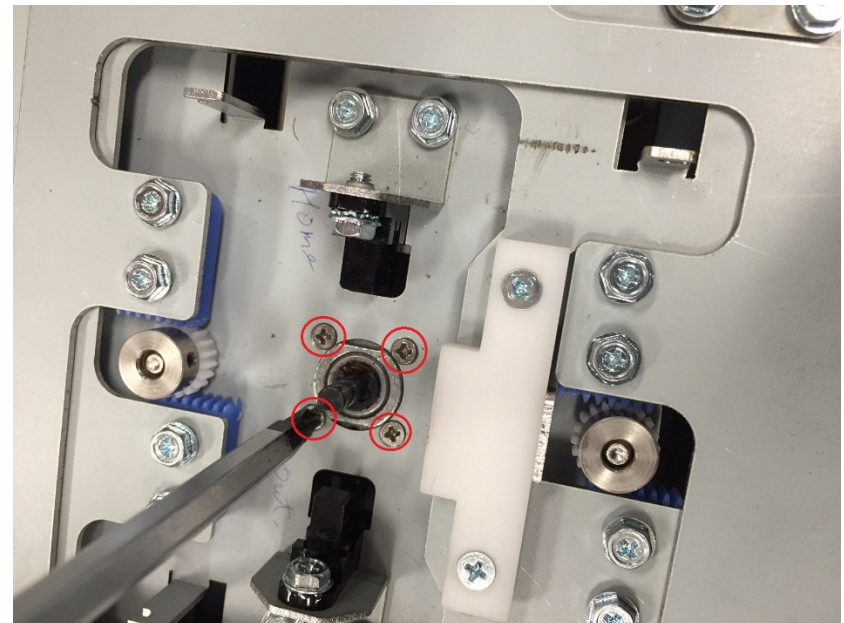

7. Remove the Expanding T Motor by sliding it out of the bottom of the module.

## Installation Procedure

1. Secure the new Motor to the frame using the M2 Screws (4).
2. Do REP 3.15.9 [Expanding T Cam Replacement](#) to install the Expanding T Cam.
3. Do REP 3.15 [Element Transfer Module Replacement](#) to install the Element Transfer Module.
4. Connect the Power Cord.
5. Power ON the eWire.

## REP 3.15.9 Expanding T Cam Replacement

### PARTS LIST ON PL 5.13

Use this procedure to remove and install the Expanding T Cam.

### WARNING

**Do not perform repair activities with the power on or electrical power supplied to the machine. Some machine components contain dangerous electrical voltages that can result in electrical shock and possible serious injury. See Section 0, page vi for other languages.**

### Removal Procedure

1. Switch power OFF to eWire.
2. Disconnect the Power Cord.
3. Remove the Expanding T top cover by removing the M3 Screws (4).
4. Loosen the M3 Set Screw securing the Cam to the motor shaft. Slide the Cam Assembly off the motor shaft.

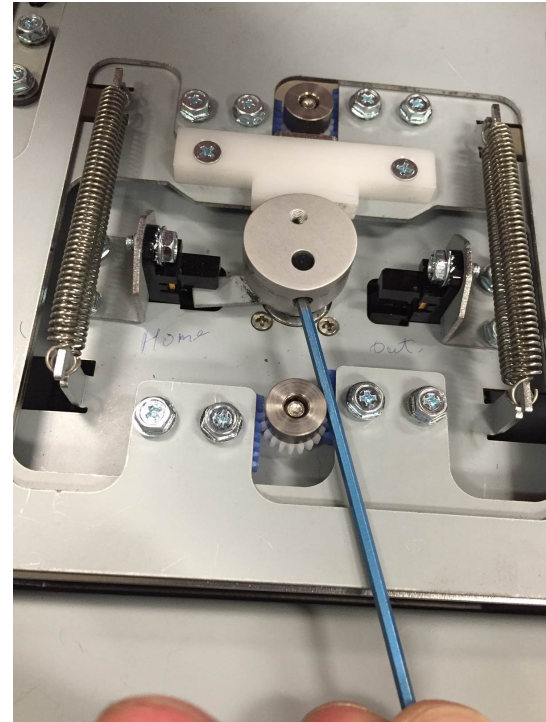

Remove the Expanding T flag from the Cam by removing the M3 Flat Head Screw. Set aside the flag.

## Installation Procedure

1. Secure the Expanding T flag to the new Expanding T Cam by tightening the M3 Flat Head Screw.
2. Slide the new Expanding T Cam onto the Motor shaft.
3. Secure the new Cam by tightening the Set Screw.
4. Replace the Expanding T Top Cover.
5. Do REP 3.15 [Element Transfer Module Replacement](#) to install the Element Transfer Module.
6. Connect the Power Cord.
7. Power ON the eWire.

## REP 3.15.10 Expanding T Spring Replacement

### PARTS LIST ON PL 5.13

Use this procedure to remove and install the Expanding T Spring. There are 2 springs on each side of the module, for a total of 4.

### WARNING

**Do not perform repair activities with the power on or electrical power supplied to the machine. Some machine components contain dangerous electrical voltages that can result in electrical shock and possible serious injury. See Section 0, page vi for other languages.**

### Removal Procedure

1. Switch power OFF to eWire.
2. Disconnect the Power Cord.
3. Remove the Expanding T top cover by removing the M3 Screws (4).
4. Remove the old spring by pulling the loop up and off the hook.

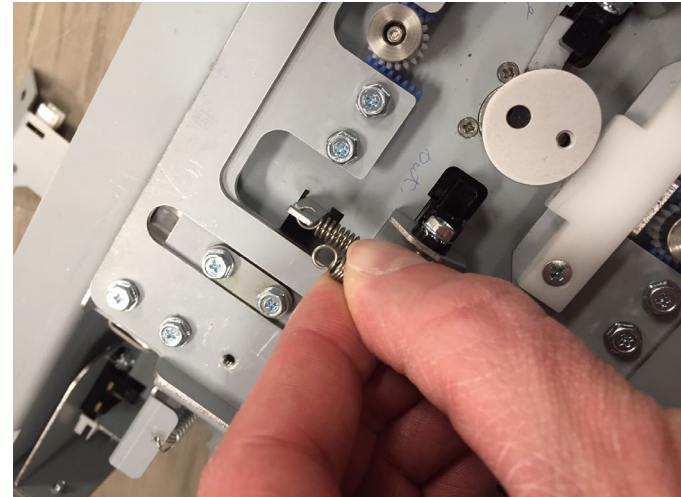

5. Repeat the procedure for the remaining springs.

### Installation Procedure

1. Secure the new spring to the Expanding T by placing the loops on each end of the spring onto the appropriate hooks on the Element Transfer and Expanding T.
2. Repeat the process for the remaining springs.
3. Replace the Expanding T Top Cover.
4. Connect the Power Cord.
5. Power ON the eWire.

### REP 3.15.11 Expanding T Motor Counterbalance Spring Replacement

#### PARTS LIST ON PL 5.13

Use this procedure to remove and install the Expanding T Motor Counterbalance Spring.

#### **WARNING**

**Do not perform repair activities with the power on or electrical power supplied to the machine. Some machine components contain dangerous electrical voltages that can result in electrical shock and possible serious injury. See Section 0, page vi for other languages.**

#### Removal Procedure

1. Switch power OFF to eWire.
2. Disconnect the Power Cord.
3. Open the Element Feeder door and slide out the Element Feeder drawer.
4. Remove the old spring by pulling the end of the spring off the mounting hole. Repeat for the other end of the spring.

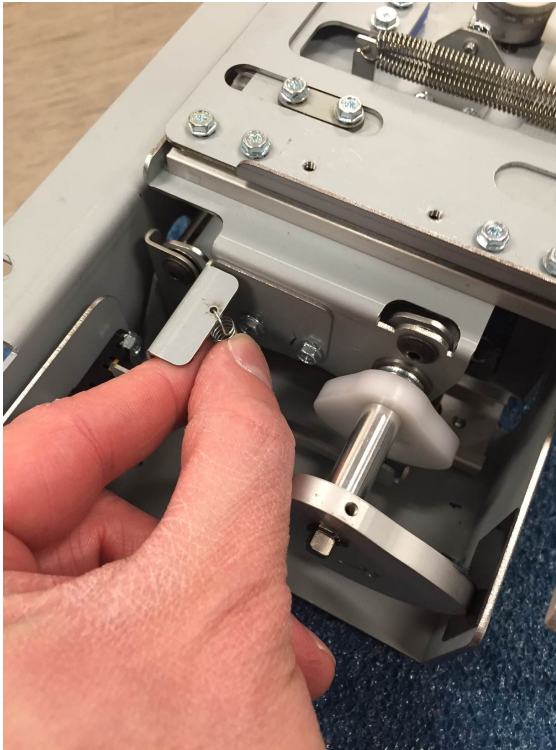

#### Installation Procedure

1. Loop the new spring onto the upper mounting hole. Stretch the spring and secure the opposite end to the lower mounting hole.
2. Connect the Power Cord.
3. Power ON the eWire.

### REP 3.15.12 Expanding T Pushover Spring Replacement

#### PARTS LIST ON PL 5.13

Use this procedure to remove and install the Expanding T Pushover Spring.

#### WARNING

**Do not perform repair activities with the power on or electrical power supplied to the machine. Some machine components contain dangerous electrical voltages that can result in electrical shock and possible serious injury. See Section 0, page vi for other languages.**

#### Removal Procedure

1. Switch power OFF to eWire.
2. Disconnect the Power Cord.
3. Do REP 3.15 [Element Transfer Module Replacement](#) to remove the Element Transfer Module.
4. Loosen the old spring by unhooking the loop at the end of the spring, and remove the spring from the module.
5. Repeat the procedure for the spring on the opposite side.

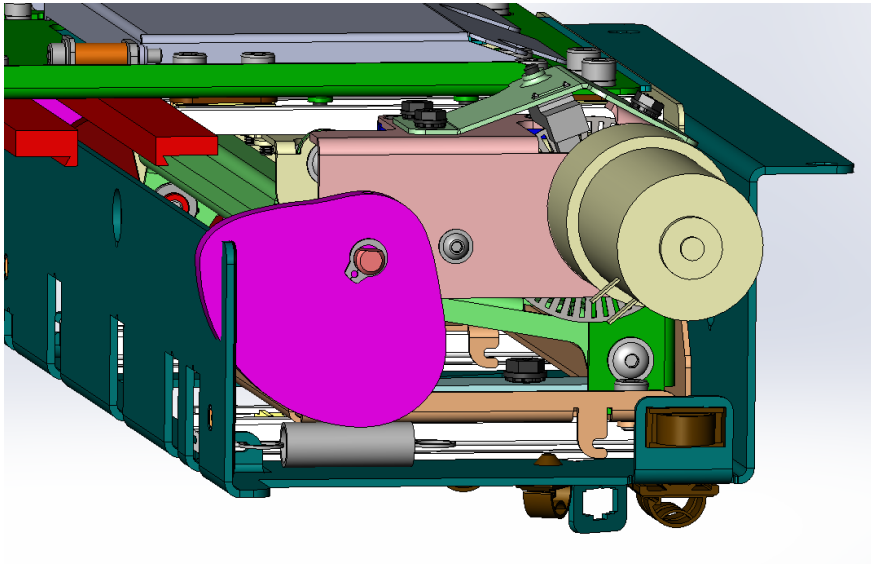

#### Installation Procedure

1. Loop the new spring onto the hook. Stretch the spring and secure the opposite end to the other hook.
2. Repeat the process for the spring on the opposite side.
3. Connect the Power Cord.
4. Power ON the eWire.

### **REP 3.15.13 Expanding T, Leading and Trailing Replacement**

#### **PARTS LIST ON PL 5.13**

Use this procedure to remove and install the Expanding T Pickup Arms, Leading and Trailing.

#### **WARNING**

**Do not perform repair activities with the power on or electrical power supplied to the machine. Some machine components contain dangerous electrical voltages that can result in electrical shock and possible serious injury. See Section 0, page vi for other languages.**

#### **Removal Procedure**

1. Switch power OFF to eWire.
2. Disconnect the Power Cord.
3. Remove the M3 Screws (2) securing the Expanding T Leading Plate.

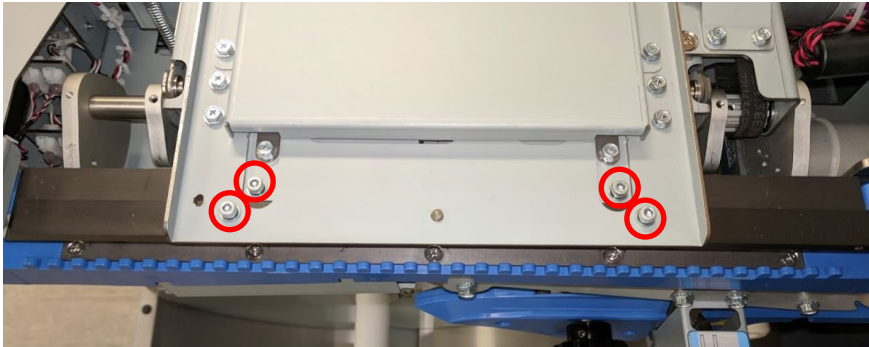

4. Remove the Leading Plate from the Expanding T module.
5. Remove the M3 Screws (2) securing the Trailing Expanding T Plate.
6. Remove the Trailing Expanding T Plate.

#### **Installation Procedure**

1. Align the new Expanding T Trailing Plate to the module and secure it using the M3 Screws (2).
2. Align the new Expanding T Leading Plate to the module and secure it using the M3 Screws (2).
3. Connect the Power Cord.
4. Power ON the eWire.



## REP 3.16 Element Feeder Drawer Switch Replacement

### PARTS LIST ON PL 5.25

Use this procedure to remove and install the Element Slack Sensor.

### WARNING

**Do not perform repair activities with the power on or electrical power supplied to the machine. Some machine components contain dangerous electrical voltages that can result in electrical shock and possible serious injury. See Section 0, page vi for other languages.**

### Removal Procedure

1. Switch power OFF to eWire.
2. Disconnect the Power Cord.
3. Perform REP 1.4 [Door Top Hinge Bracket Replacement](#) to remove rear cover.
4. Remove the two connectors attached to the Snap Switch.
5. Remove the M3 Screws (2) securing the switch.



### Installation Procedure

1. Reverse the steps in the Removal Procedure.
2. Attach the connectors as shown, the white wire goes to the middle terminal and the black wire goes to the rear most terminal.



3. Connect the Power Cord.
4. Switch power ON to eWire.

### REP 3.17 Element Feeder Alignment Pin Bracket Replacement PARTS LIST ON PL 5.9

Use this procedure to remove and install the Alignment Pin Bracket Assembly.

#### **WARNING**

**Do not perform repair activities with the power on or electrical power supplied to the machine. Some machine components contain dangerous electrical voltages that can result in electrical shock and possible serious injury. See Section 0, page vi for other languages.**

#### **Removal Procedure**

1. Switch power OFF to eWire.
2. Disconnect the Power Cord.
3. Perform REP 1.8 [Front Cover Replacement](#) to remove Front Cover.
4. Open the Element Feeder Door and pull the Element Feeder Drawer all the way out.
5. Remove the M4 Screws (2) to remove the Alignment Pin Bracket Assembly.

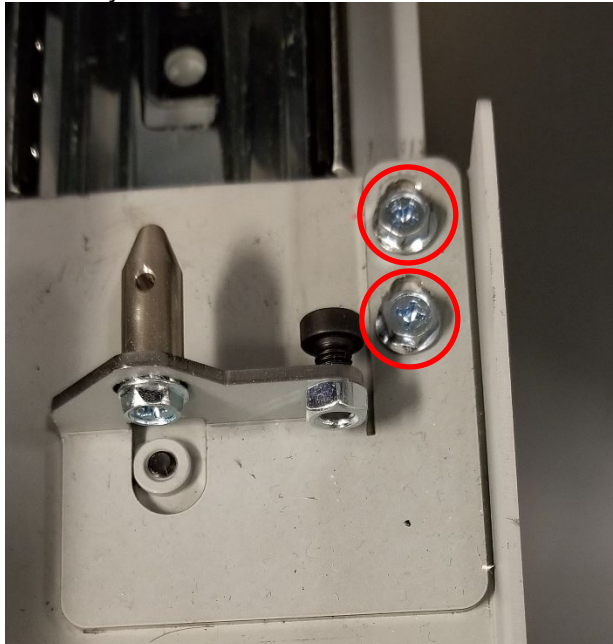

#### **Installation Procedure**

1. Reverse the steps in the Removal Procedure.
2. Perform ADJ 1.15 [Element Feeder Horizontal Position Adjustment](#) to set the position of the bracket and M5 Socket Head Screw.
3. Connect the Power Cord
4. Switch power ON to eWire.

## REP 3.18 Element Slack Detect Lever Assembly Replacement

### PARTS LIST ON PL 5.10

Use this procedure to remove and install the Element Slack Detect Lever Assembly.

### WARNING

**Do not perform repair activities with the power on or electrical power supplied to the machine. Some machine components contain dangerous electrical voltages that can result in electrical shock and possible serious injury. See Section 0, page vi for other languages.**

### Removal Procedure

1. Switch power OFF to eWire.
2. Disconnect the Power Cord.
3. Do GP 6.8 to remove the Supply Spool, Rewind Spool.
4. Remove the Spool Detect Cover, curved Front Baffle, and curved Rear Baffle by removing the M3 screws that secure those Items in place.

**Note:** You will need to remove the Spool Detect Cover first, to expose one screw each on the Front and Rear Baffles to remove them.

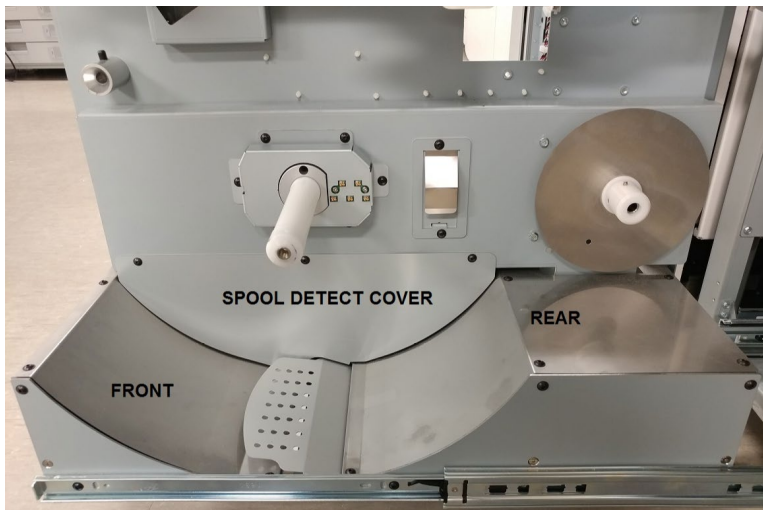

5. Remove the M3 screws (2) then pivot assembly up and out as shown to remove the Element Slack Detect Lever assembly.

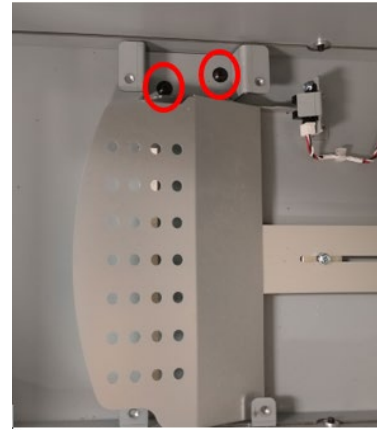

6. Slide Element Slack Detect Lever off of the Pivot Shaft then replace with new part.

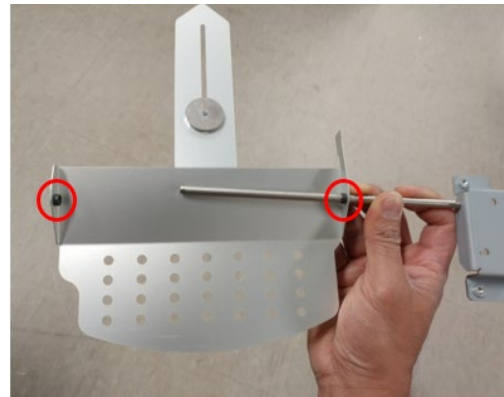

**Note:** Be sure not to lose the Plastic Flanged Bearings (circled above) and transfer them to the new Element Slack Detect Lever or replace if necessary.

### Installation Procedure

1. Reverse the steps in the Removal Procedure.
2. Perform ADJ 1.2 [Element Slack Detection Lever Adjustment](#) to adjust the sensitivity of the Element Slack Detect Lever Assembly.
3. Connect the Power Cord
4. Switch power ON to eWire.

## REP 3.19 Spool Rewind Belt Replacement

### PARTS LIST ON PL 5.8

Use this procedure to remove and install the Spool Rewind Drive Assembly. The Spool Rewind Motor (M8) and Spool Rewind Belt are included as part of this assembly.

### WARNING

**Do not perform repair activities with the power on or electrical power supplied to the machine. Some machine components contain dangerous electrical voltages that can result in electrical shock and possible serious injury. See Section 0, page vi for other languages.**

### Removal Procedure

1. Switch power OFF to eWire.
2. Disconnect the Power Cord.
3. Open the Front Door and slide out the Element Feeder drawer.
4. Do GP 6.8 to remove the Supply Spool.
5. Remove the Element Feeder Door. Follow procedure REP 1.2 to remove the Element Feeder Door.
6. Remove the Element Feeder Rear Cover by removing the M4 Screws (8). The bottom screws can be used as a pivot to aid removal.

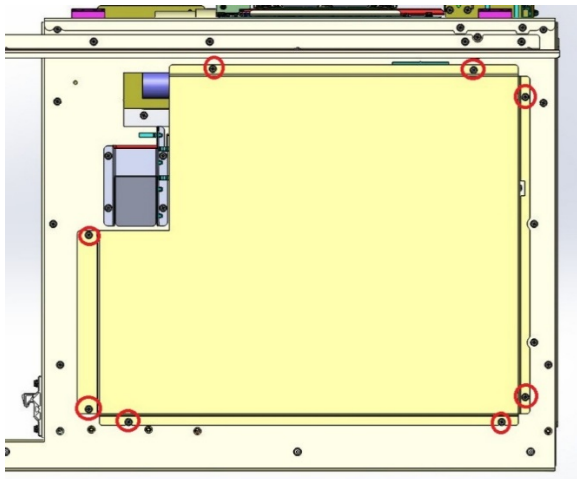

7. Do GP 6.8 to remove the Supply Spool, Rewind Spool.
8. Remove the M3 screws that secure the Spool Detect Cover and the curved Front and Rear Baffles.



9. Remove the Spool Detect Sensor Cover by removing the M4 Screws (2) and set aside.

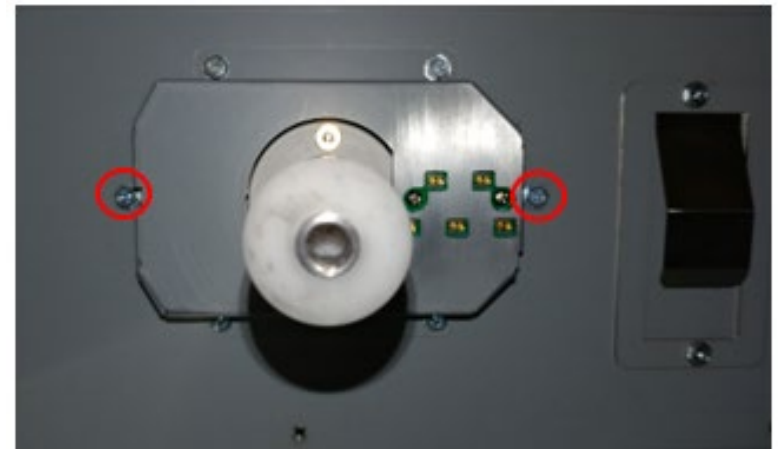

10. Remove the M4 screws (4) from the Sensor Bracket to gain access to the Element Size Detect and Spool Empty sensor connectors then disconnect them. Place Sensor Bracket aside.

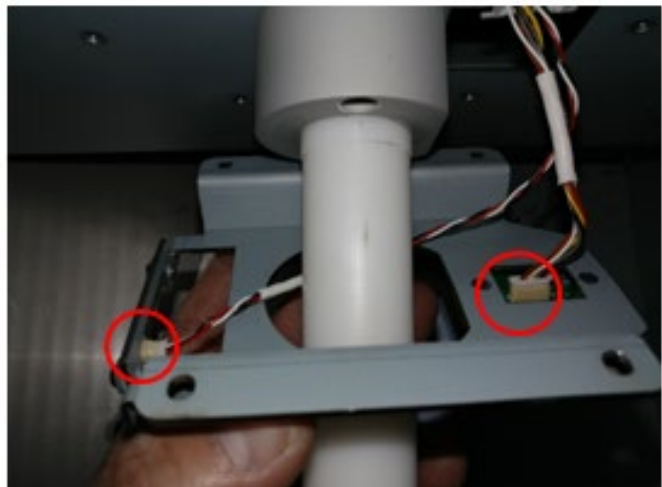

11. Disconnect the Spool Rewind Motor Cable at the header.



12. Remove the M4 Screws (8) securing the Spindle Frame Assembly to the Element Feeder. Carefully tilt the Spindle Frame Assembly forward to remove it from the Element Feeder Body and place it on a table or workspace.

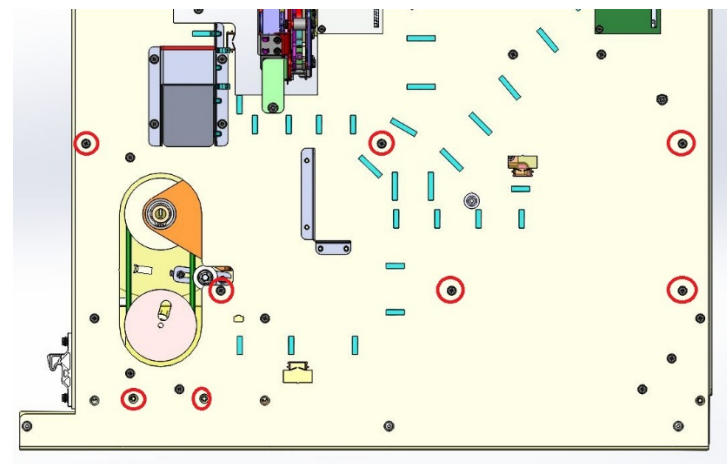

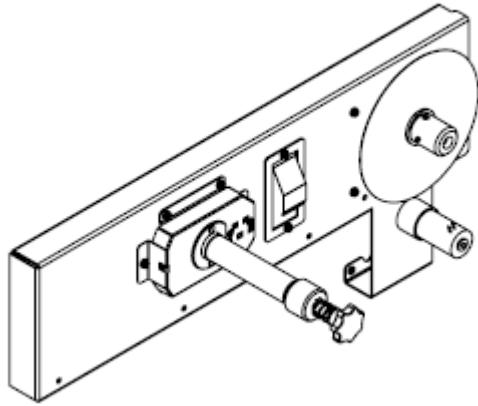

Spindle Frame Assembly

13. Remove the Retaining Ring and Washer from rear side of the Rewind Hub.

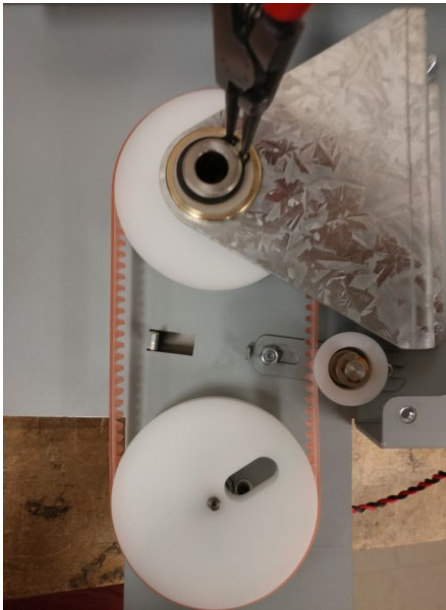

14. Remove the M4 screws (2) on the front side of the Spindle Frame Assembly so that you can remove the Rewind Shaft Support Bracket.

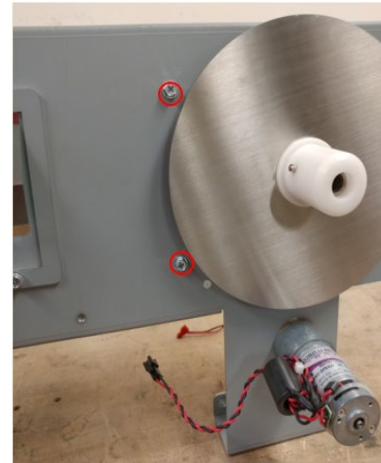

15. Slide the belt off of the pulley and replace with new belt. If necessary, loosen the M4 Screws on the Belt Tensioner and slide the Tensioner away to relieve tension on the Spool Rewind Belt.

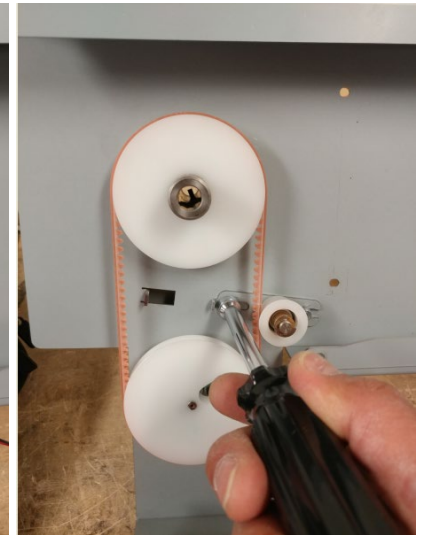
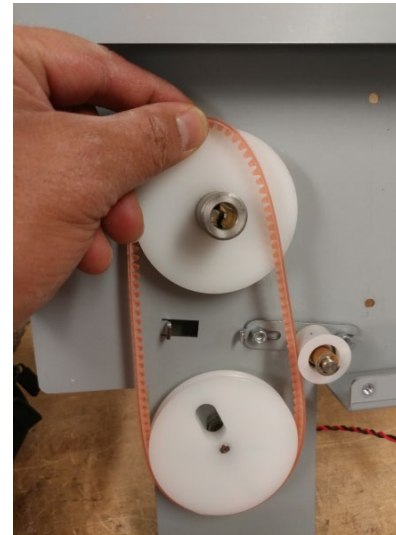

## **Installation Procedure**

1. Reverse the steps found in the Removal Procedure.
2. Connect the Power Cord.
3. Power ON the eWire.

### **Note:**

Make sure that the M4 screws in step 13 are tight to prevent Spindle from tilting toward Spool, causing paper tears.

## 4. Vacuum Stacker Module

### REP 4.1 Vacuum Stacker Module Replacement

#### PARTS LIST ON PL 3.5

Use this procedure to remove and replace the Vacuum Stacker.

#### Removal Procedure

### WARNING

**Do not perform repair activities with the power on or electrical power supplied to the machine. Some machine components contain dangerous electrical voltages that can result in electrical shock and possible serious injury. See Section 0, page vi for other languages.**

1. Turn off Power to the eWire.
2. Disconnect the Power Cord.
3. Raise the Lid.
4. Disconnect the cable from the Vacuum Stacker.

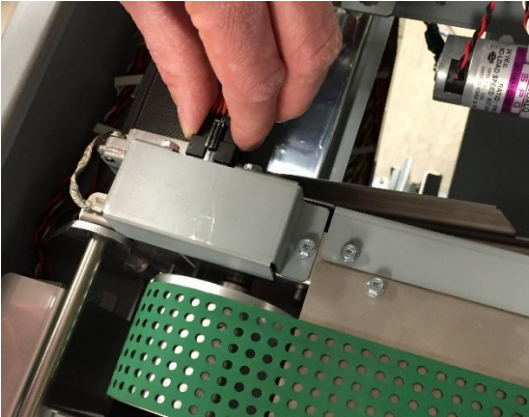

5. Disconnect the motor from the Driver Board Extension Cable

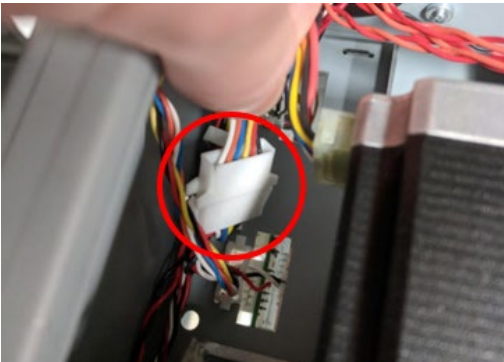

6. Remove the M5 Screws (2) and Hinge Pivots (2). Leave the Tray in the machine.



7. Remove the M4 screws (2) from the front hinge bracket.

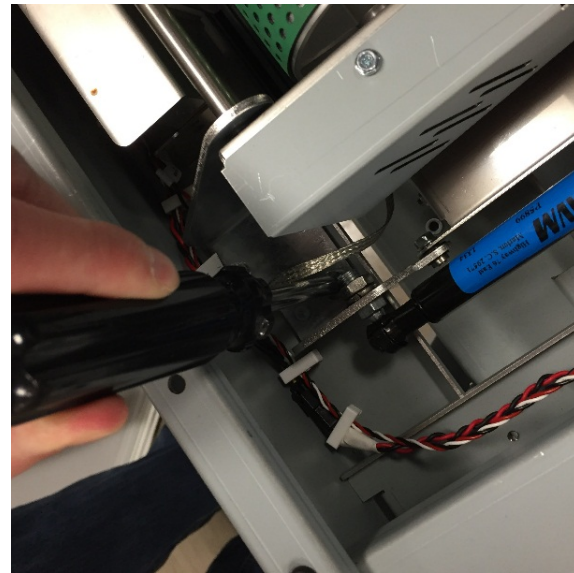



- Repeat the procedure to remove the M4 Screws (2) from the rear hinge bracket.

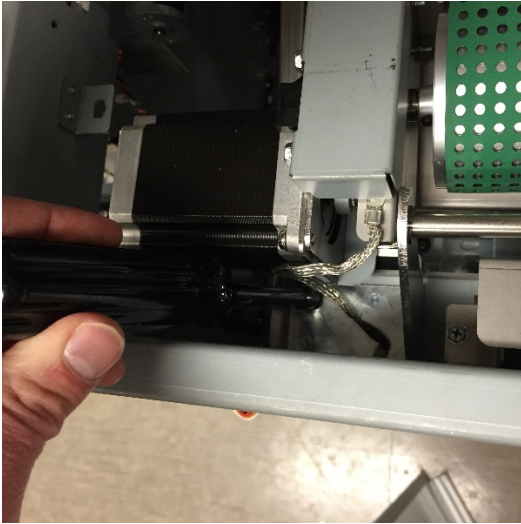

- Carefully lift the Vacuum Stacker out of the machine.

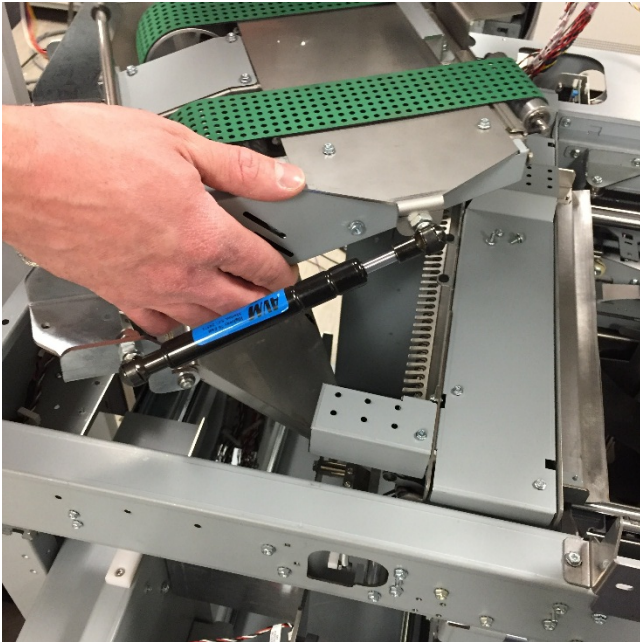

## Installation Procedure

- Reverse Steps for Installation.

## REP 4.2 Solenoid Replacement, Kickdown Solenoid, Rear (L7)

### PARTS LIST ON PL 5.14

Use this procedure to remove and install the rear Kickdown Solenoid Assembly.

#### Removal Procedure

#### WARNING

**Do not perform repair activities with the power on or electrical power supplied to the machine. Some machine components contain dangerous electrical voltages that can result in electrical shock and possible serious injury. See Section 0, page vi for other languages.**

1. Switch power OFF to eWire.
2. Disconnect the Power Cord.
3. Do REP 4.1 [Vacuum Stacker Module Replacement](#) to remove the Vacuum Stacker.
4. Remove (3) M3 Screws securing the rear cover and remove the cover.

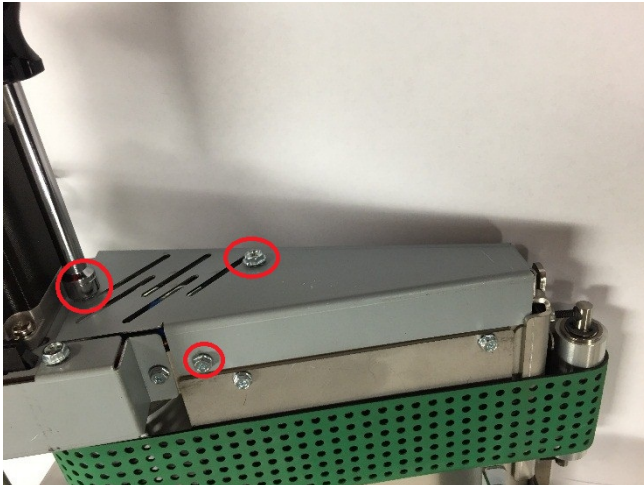

5. Disconnect the solenoid wires at the header
6. Loosen the set screw securing the clevis to the rotating shaft.

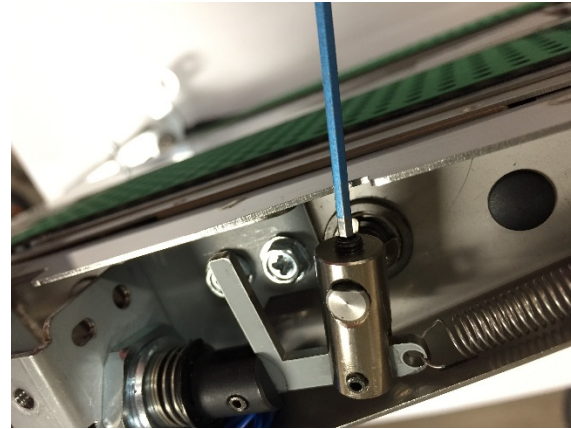

7. Disconnect the extension spring from the kick-down solenoid assembly.

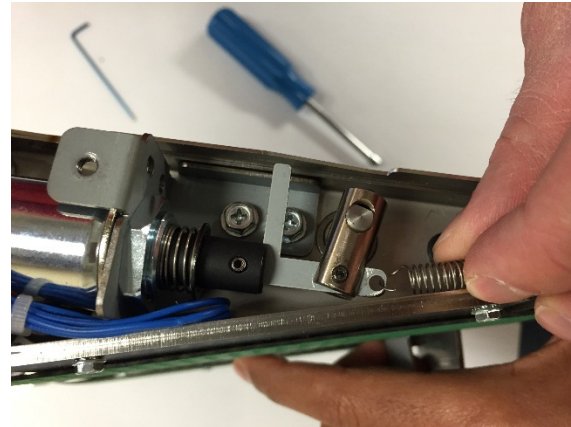

8. Loosen and remove the M4 Screws (2) securing the kick-down solenoid mounting bracket, and remove the Solenoid Assembly.

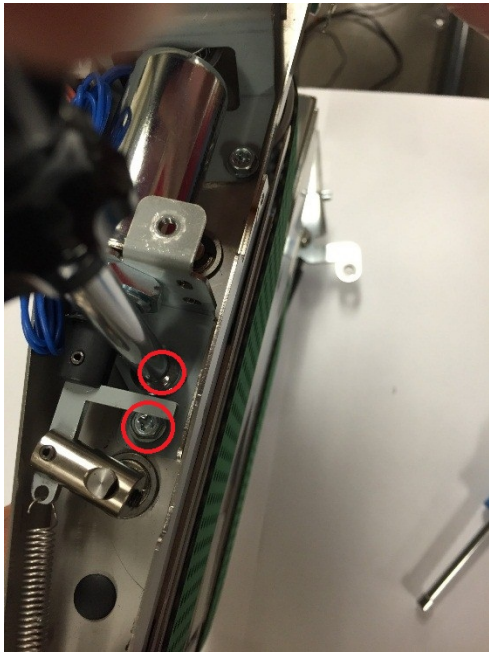

9. Use an adjustable wrench to loosen the nut securing the Solenoid to the bracket.

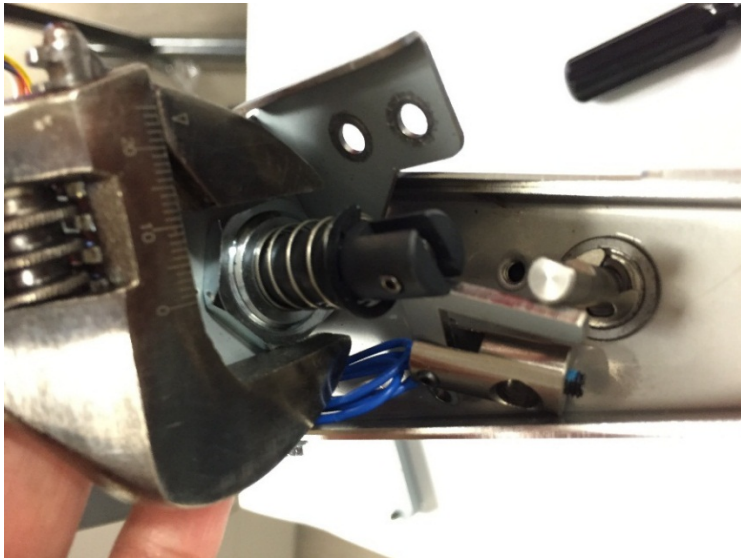

10. Remove the Kick-Down Solenoid Assembly from the Vacuum Stacker.

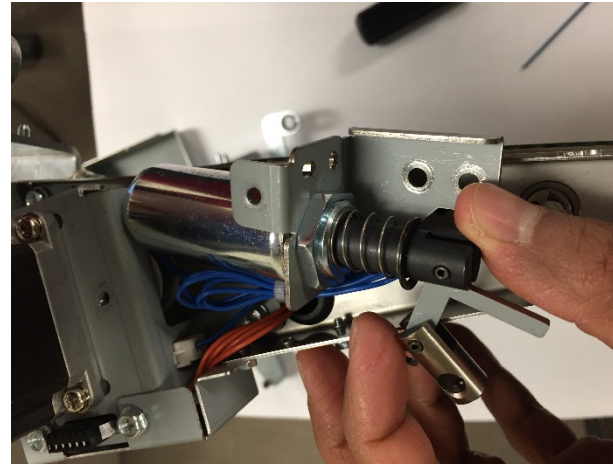

#### Installation Procedure

1. Reverse the steps from the Removal Procedure.
2. Do REP 4.1 [Vacuum Stacker Module Replacement](#) to install the Vacuum Stacker.
3. Connect the Power Cord
4. Turn on the eWire.

### REP 4.3 Solenoid Replacement, Kickdown Solenoid, Front (L7)

#### PARTS LIST ON PL 5.14

Use this procedure to remove and install the front Kickdown Solenoid.

#### Removal Procedure

#### WARNING

**Do not perform repair activities with the power on or electrical power supplied to the machine. Some machine components contain dangerous electrical voltages that can result in electrical shock and possible serious injury. See Section 0, page vi for other languages.**

1. Switch power OFF to eWire.
2. Disconnect the Power Cord.
3. Do REP 4.1 [Vacuum Stacker Module Replacement](#) to remove the Vacuum Stacker.
4. Remove (3) M3 Screws securing the front cover and remove the front cover.

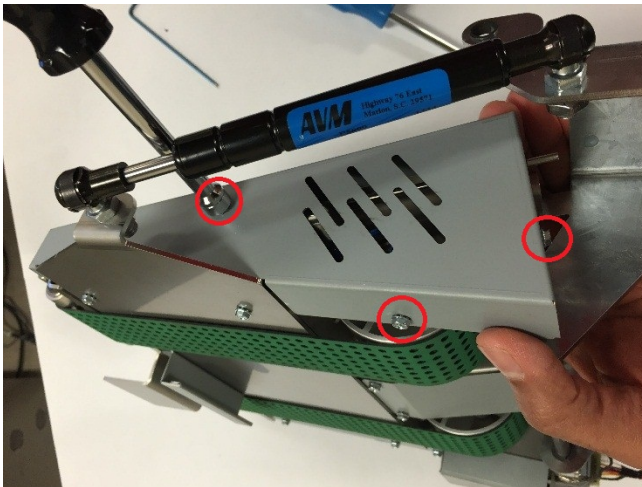

5. Disconnect the solenoid wires from the Vacuum Stacker.
6. Disconnect the extension spring from the kick-down solenoid assembly.

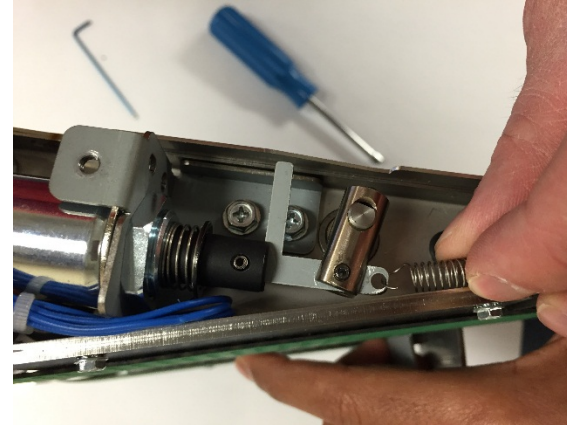

7. Loosen the set screw securing the clevis to the rotating shaft.

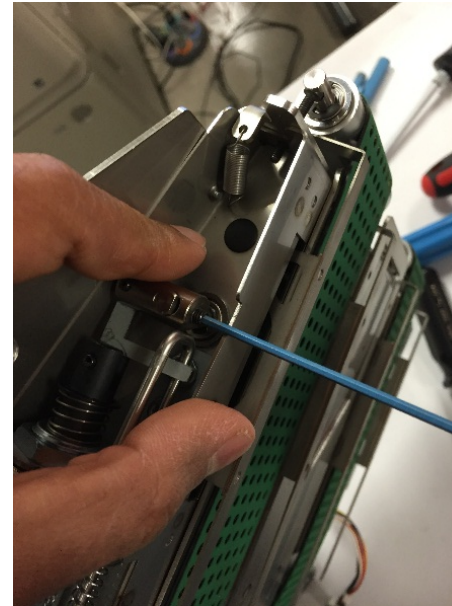

- Using a screwdriver, remove the e-ring providing tension to the kick-down retract spring. (Note: Spring retainer differs from picture below). Loosen the kick-down retract spring.

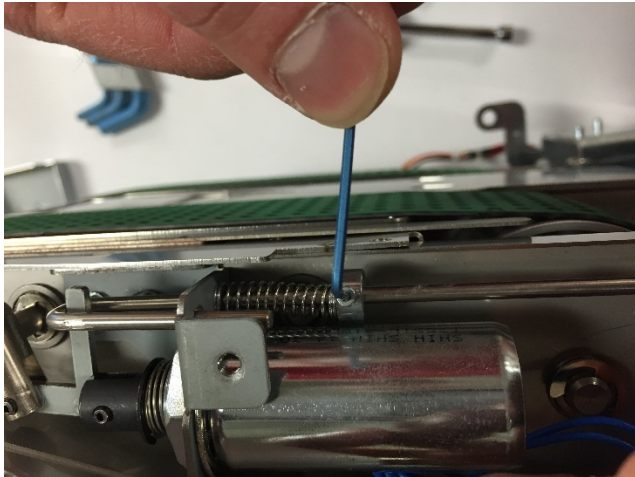

- Loosen and remove the M4 Screws (2) securing the kick-down solenoid mounting bracket, and remove the bracket from the module.



- Use an adjustable wrench to loosen the nut securing the Solenoid to the bracket.

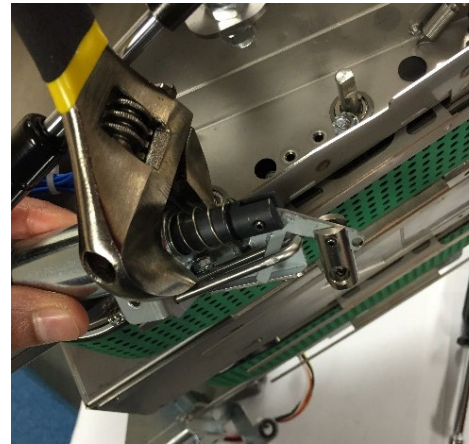

- Remove the Kick-Down Solenoid Assembly from the Vacuum Stacker.

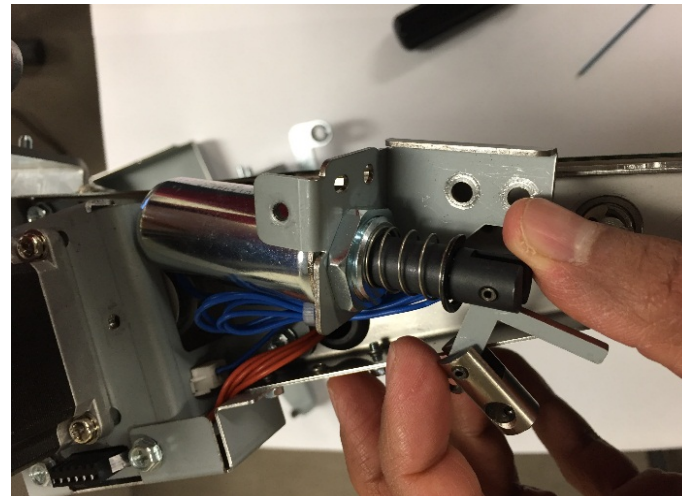

#### Installation Procedure

- Reverse the steps from the Removal Procedure. Ensure that the kick-down retract rod is installed around the leg on the Kick-Down Solenoid Assembly.
- Do REP 4.1 [Vacuum Stacker Module Replacement](#) to install the Vacuum Stacker.
- Connect the Power Cord
- Turn on the eWire.

## REP 4.4 Solenoid Replacement, Drag Finger Solenoid (L6)

### PARTS LIST ON PL 5.14

Use this procedure to remove and install the Drag Finger Solenoid

#### Removal Procedure

#### WARNING

**Do not perform repair activities with the power on or electrical power supplied to the machine. Some machine components contain dangerous electrical voltages that can result in electrical shock and possible serious injury. See Section 0, page vi for other languages.**

1. Switch power OFF to eWire.
2. Disconnect the Power Cord.
3. Do REP 4.1 [Vacuum Stacker Module Replacement](#) to remove the Vacuum Stacker.
4. Loosen (4) M3 Screws securing the Port Cover and remove it.

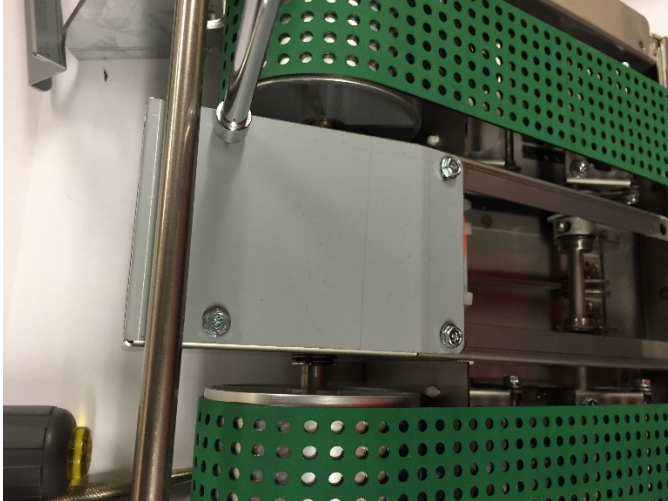

5. Loosen the M3 Screws (2) and remove the lift handle.

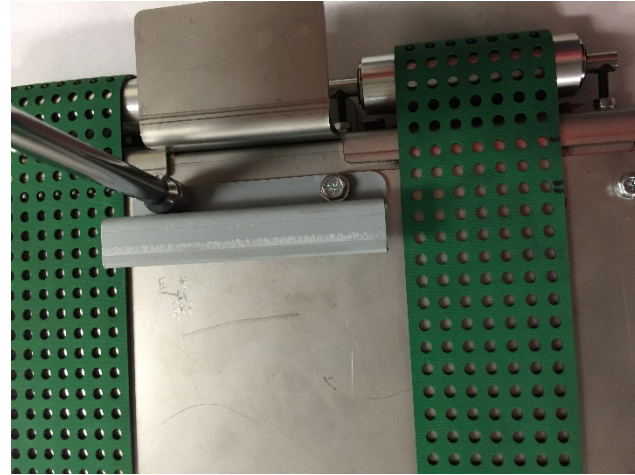

6. Using a flat head screwdriver, loosen and remove the gas spring socket from the top cover.

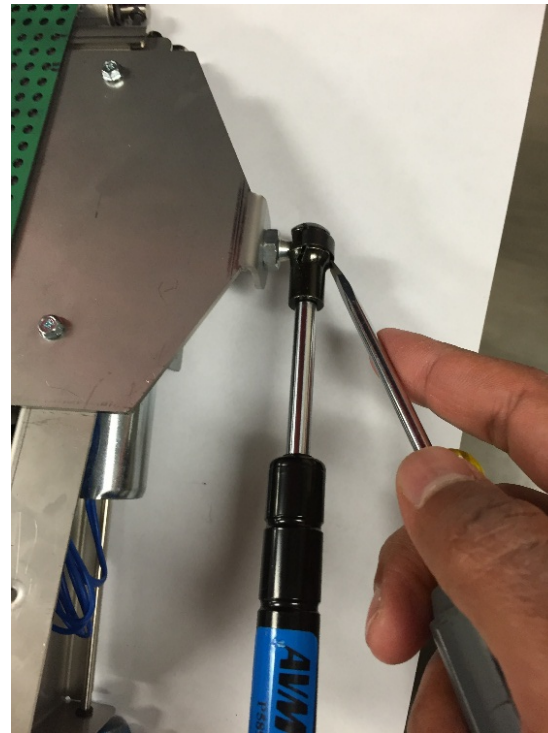

7. Loosen and remove the M3 Screws (4) securing the top cover and remove the top cover. Carefully slide the top cover out under the green belts.

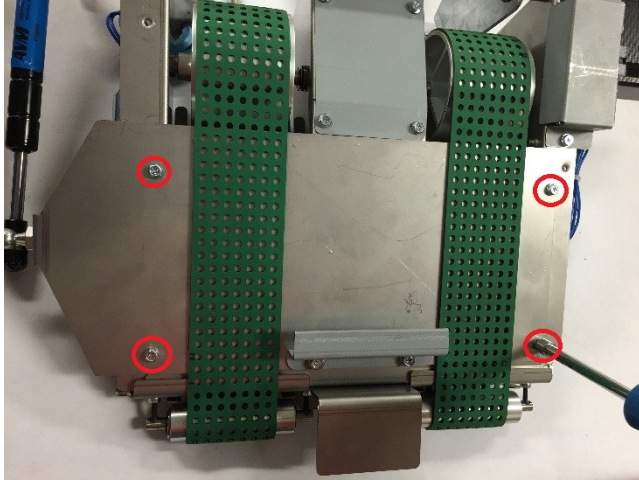

8. Unclip the wires from the cable connectors on the solenoid mounting bracket.

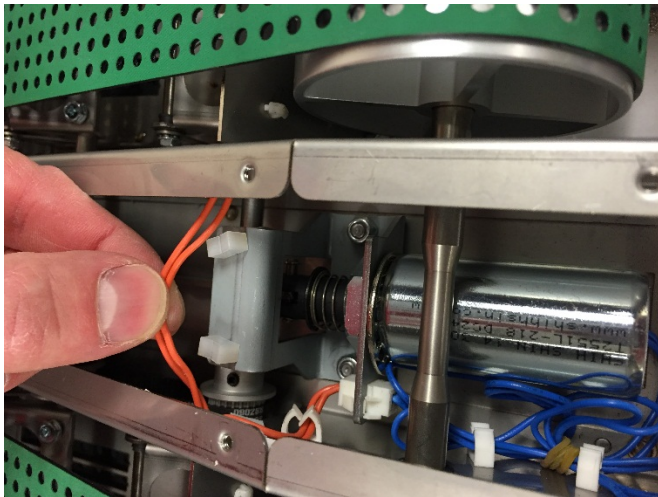

9. Disconnect the solenoid wires from the header. It may be necessary to use long-nose pliers to reach the cable connection.

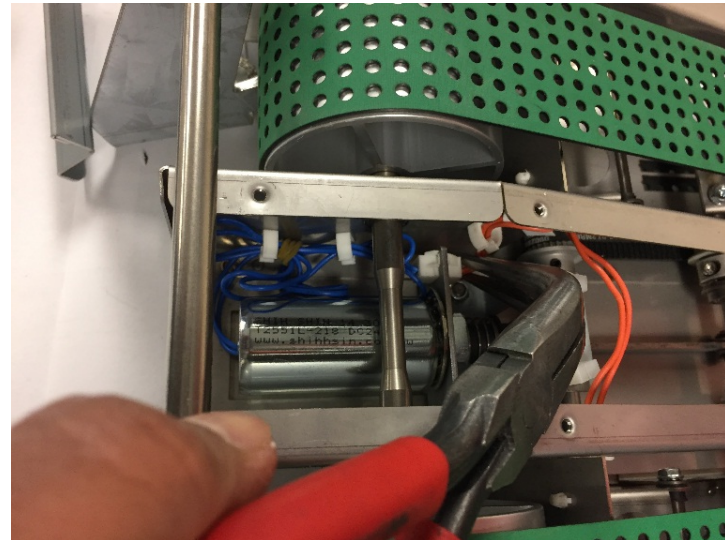

10. Loosen the M4 nuts (2) securing the Solenoid Mounting Bracket and loosen the mounting bracket. Do not remove it completely.

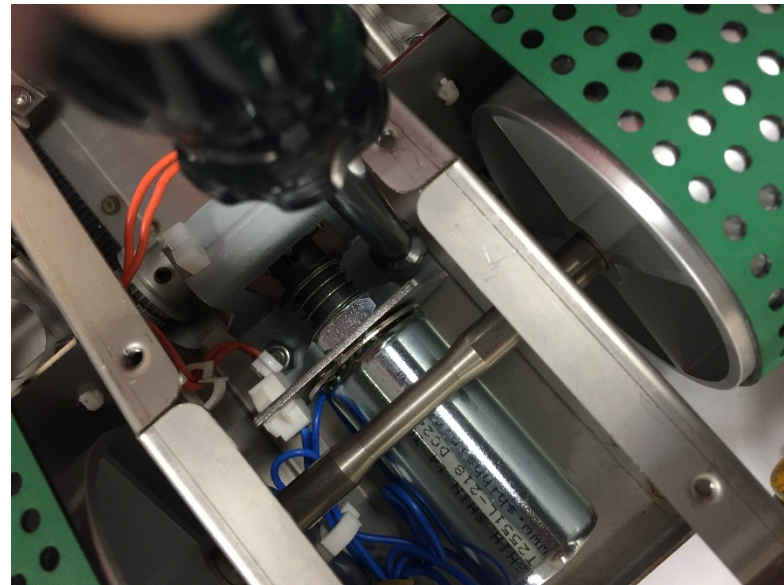

11. Using Pliers or a screwdriver, remove the e-rings securing the drag finger link pin. Remove the link pin.
12. Use an adjustable wrench to loosen the nut connecting the solenoid to the solenoid mounting bracket.
13. Remove the Solenoid from the module.

#### **Installation Procedure**

1. Reverse the steps from the Removal Procedure.
2. Do REP 4.1 [Vacuum Stacker Module Replacement](#) to install the Vacuum Stacker.
3. Connect the Power Cord
4. Turn on the eWire.



## REP 4.5 Motor Replacement, Vacuum Stacker Drive (M5)

### PARTS LIST ON PL 5.14

Use this procedure to remove and install the Vacuum Stacker stepper motor.

#### Removal Procedure

#### WARNING

**Do not perform repair activities with the power on or electrical power supplied to the machine. Some machine components contain dangerous electrical voltages that can result in electrical shock and possible serious injury. See Section 0, page vi for other languages.**

1. Switch power OFF to eWire.
2. Disconnect the Power Cord.
3. Do REP 4.1 [Vacuum Stacker Module Replacement](#) to remove the Vacuum Stacker.
4. Disconnect the motor cables from the header.
5. Remove the motor top cover by loosening the M3 screws (3).
6. Use an Allen wrench to loosen the set screw securing the belt drive pulley.

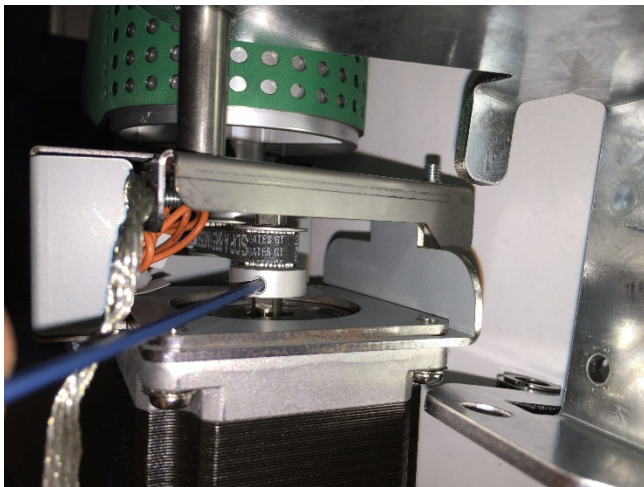

7. Remove the M4 Screws securing the motor and remove the motor from the Vacuum Stacker.

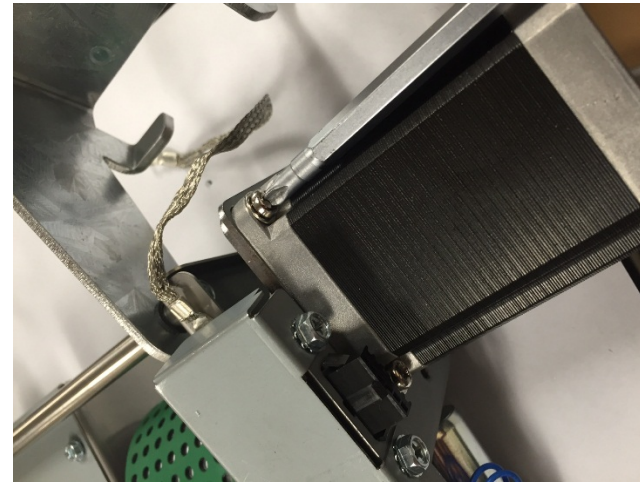

#### Installation Procedure

1. Reverse the steps from the Removal Procedure. Ensure that the drive belt has proper tension after motor installation.
2. Do REP 4.1 [Vacuum Stacker Module Replacement](#) to install the Vacuum Stacker.
3. Connect the Power Cord
4. Turn on the eWire.

## REP 4.6 Idler Pulley Assembly Replacement

### PARTS LIST ON PL 5.15

Use this procedure to remove and install the Vacuum Stacker Idler Pulley Sub-Assembly

#### Removal Procedure

#### WARNING

**Do not perform repair activities with the power on or electrical power supplied to the machine. Some machine components contain dangerous electrical voltages that can result in electrical shock and possible serious injury. See Section 0, page vi for other languages.**

1. Switch power OFF to eWire.
2. Disconnect the Power Cord.
3. Do REP 4.1 [Vacuum Stacker Module Replacement](#) to remove the Vacuum Stacker.
4. Release the lock nut on the idler pulley tensioning screw and tighten the screw into the Vacuum Stacker to loosen the belt tension on the idler pulley.

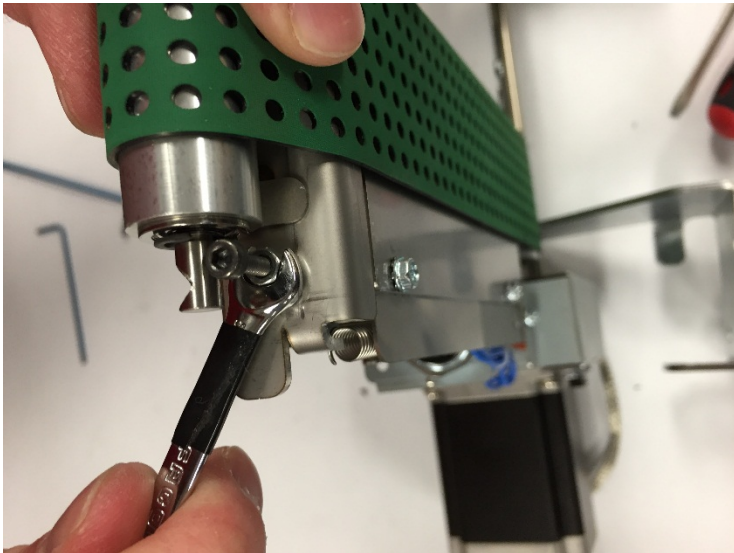

5. Lift the Idler Pulley Assembly up and off the tension adjustment screws. If removing the Pulley Assembly is too difficult, tighten the tension screws further by repeating the procedure in Step 4.

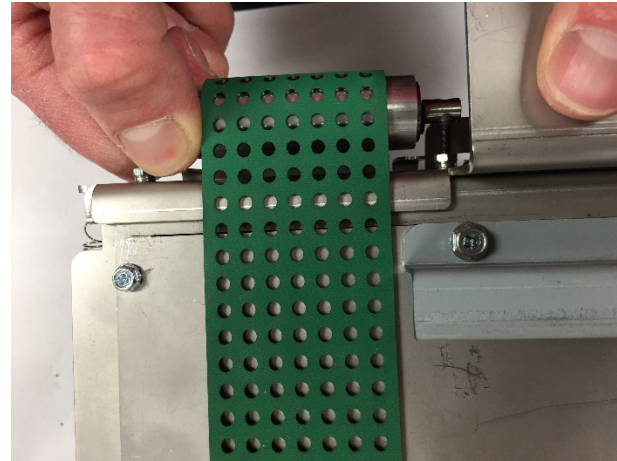

6. Carefully slide the Idler Pulley Sub-Assembly away from the belt and free of the machine. Take care to avoid damaging the Belt.

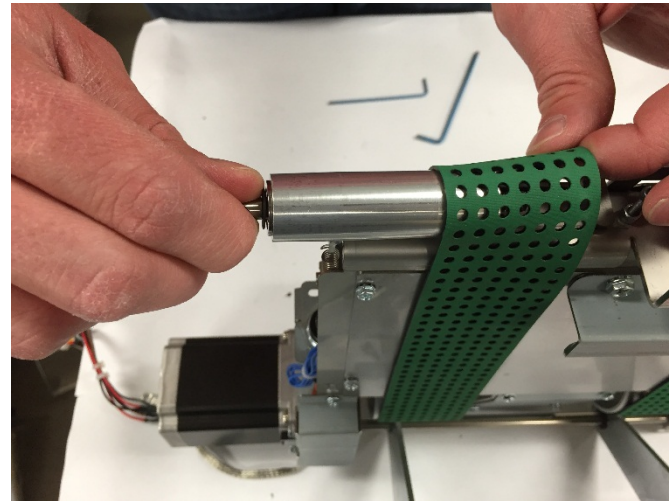

7. Repeat the procedure for the other side.

## Installation Procedure

1. Slide the new Idler Pulley Assembly between the machine frame and the Vacuum Stacker belt.
2. Carefully lift the Idler Pulley, applying light tension to the belt. Place the counter-bored holes on each end of the Idler Pulley shaft onto the heads of the tensioning screws. If it is too difficult to lift the Idler Pulley shaft onto the tensioning screws, reduce the screw height by tightening the tensioning screws.

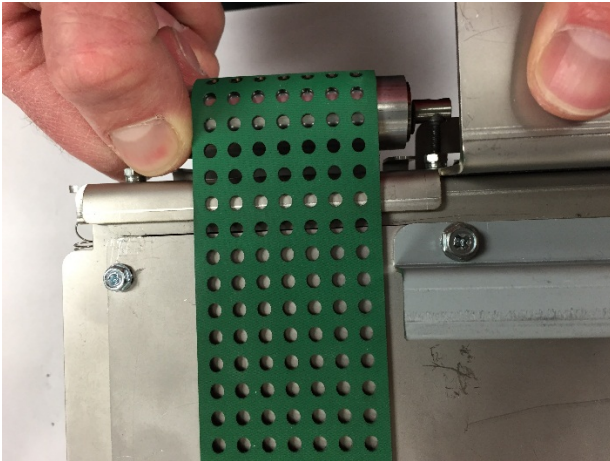

3. With the Idler Pulley Assembly in place, loosen the tensioning screws until proper tension is achieved on the Vacuum Stacker Belt. Refer to REP 4.8 [Vacuum Stacker Belt Replacement](#) for additional detail on belt replacement.

4. Tighten the lock nuts to secure the Idler Pulley Assembly.

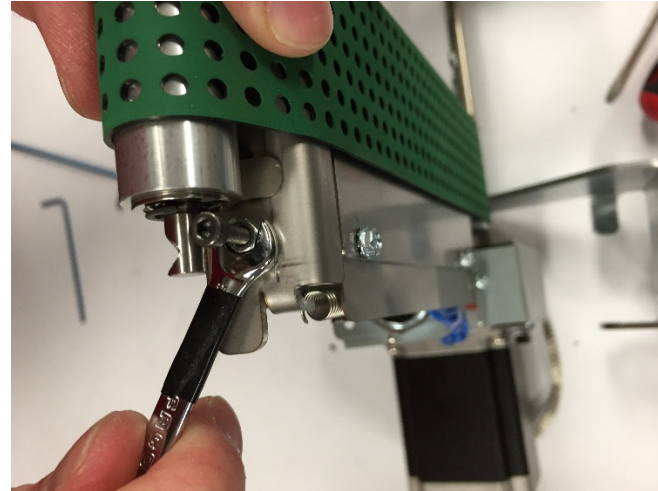

5. Do REP 4.1 [Vacuum Stacker Module Replacement](#) to install the Vacuum Stacker.
6. Connect the Power Cord
7. Turn on the eWire.

## REP 4.7 Kick-down Replacement PARTS LIST ON PL 5.15

Use this procedure to remove and install the Kick-down weldments.

### Removal Procedure

#### **WARNING**

**Do not perform repair activities with the power on or electrical power supplied to the machine. Some machine components contain dangerous electrical voltages that can result in electrical shock and possible serious injury. See Section 0, page vi for other languages.**

1. Switch power OFF to eWire.
2. Disconnect the Power Cord.
3. Do REP 4.1 [Vacuum Stacker Module Replacement](#) to remove the Vacuum Stacker.
4. Loosen the M3 Screws (2) and remove the lift handle.

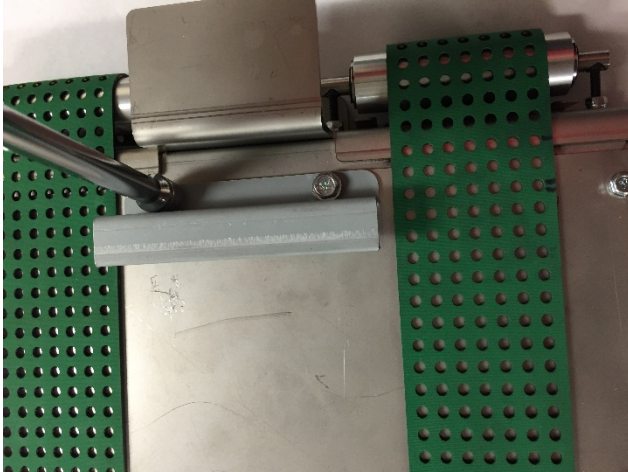

5. Using a flat head screwdriver, loosen and remove the gas spring socket from the top cover.

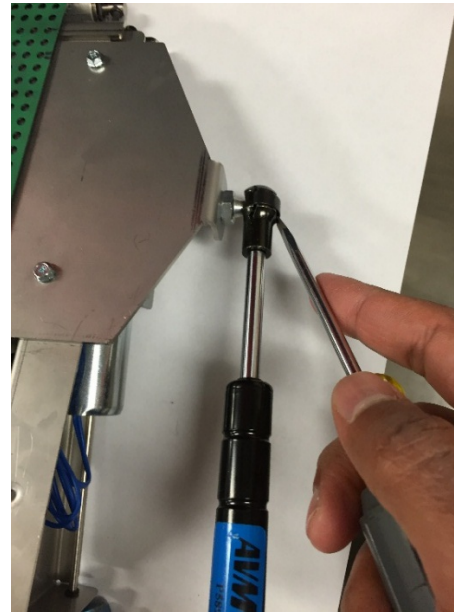

6. Loosen and remove the M3 Screws (4) securing the top cover and remove the top cover. Carefully slide the top cover out under the green belts.

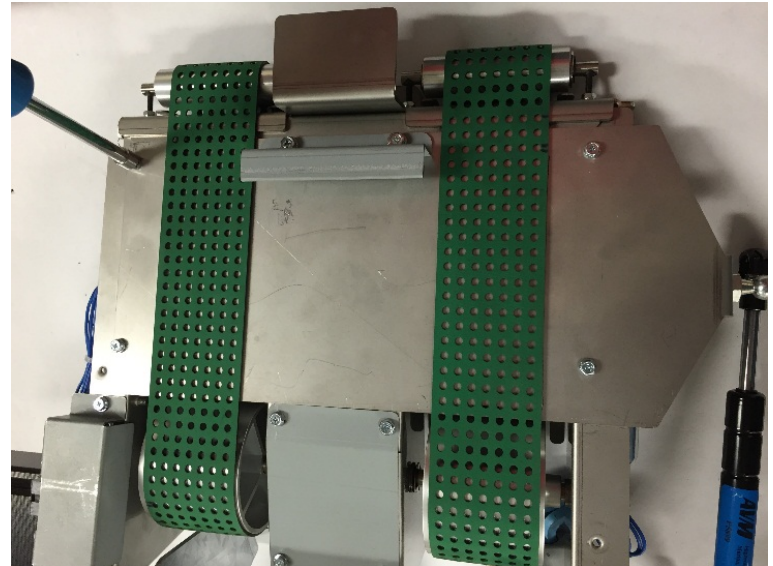

7. Loosen but do not remove the M3 Nuts (2) securing the Kick-Down Weldment to the kick-down link shaft.

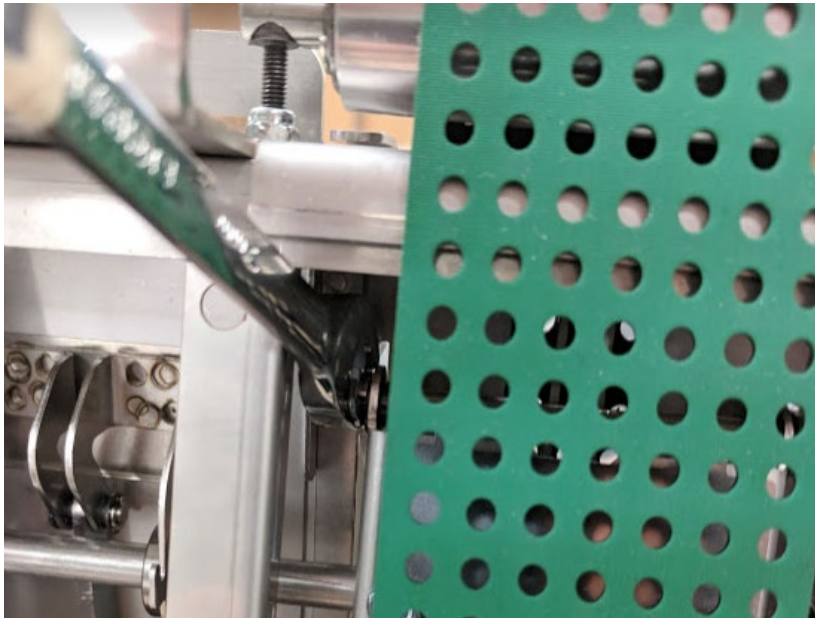

8. Slide the Kick-Down Weldment out through the bottom of the Vacuum Module.
9. For the outer Kick-Down Weldment parts, remove the side cover(s) by loosening the M3 screws (3) and remove the Plug to access the screws to attach the Kick-Down Weldment.

## Installation Procedure

1. Reverse steps 7-9 of the Removal Procedure
2. After installing all 4 kick-downs, ensure that the flats of the skis are in plane with each other when in the down position. If any are out of plane, loosen the M3 Nuts securing it and reseat it in line with the others.

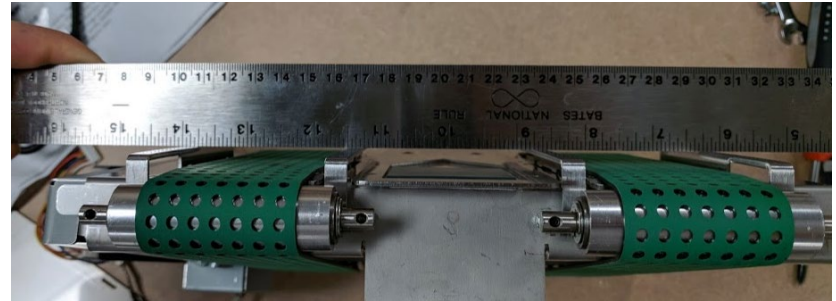

3. Also ensure that when retracted, the kick-downs are below the plane of the belts. If any are not, loosen the M3 Nuts holding the protruding kick-down and reseat it.



4. Reverse steps 1-6 from the Removal Procedure.
5. Do REP 4.1 [Vacuum Stacker Module Replacement](#) to install the Vacuum Stacker.
6. Connect the Power Cord
7. Turn on the eWire.

## REP 4.8 Vacuum Stacker Belt Replacement

### PARTS LIST ON PL 5.15

Use this procedure to remove and install the Vacuum Stacker Belt.

#### Removal Procedure

#### **WARNING**

**Do not perform repair activities with the power on or electrical power supplied to the machine. Some machine components contain dangerous electrical voltages that can result in electrical shock and possible serious injury. See Section 0, page vi for other languages.**

1. Switch power OFF to eWire.
2. Disconnect the Power Cord.
3. Do REP 4.1 [Vacuum Stacker Module Replacement](#) to remove the Vacuum Stacker.
4. Loosen the M3 Screws (3) and remove the side cover. Repeat the process for the opposite side cover.



5. Using a flat head screwdriver, loosen and remove the gas spring socket from the top cover.

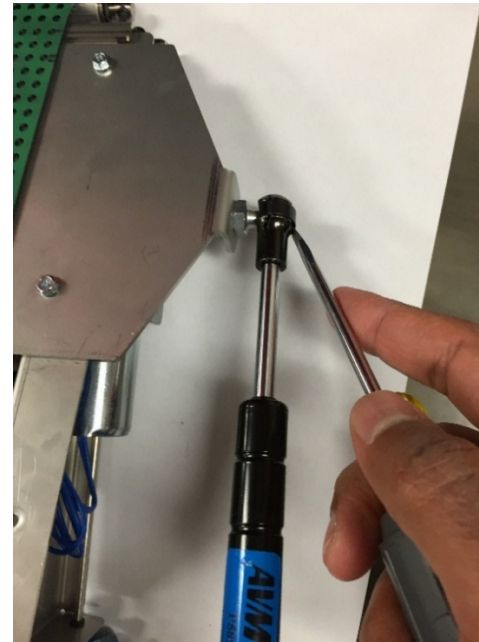

6. Loosen and remove the M5 Screws (2) securing the Vacuum shaft rod. Remove the Hinge Brackets from the Vacuum Stacker.

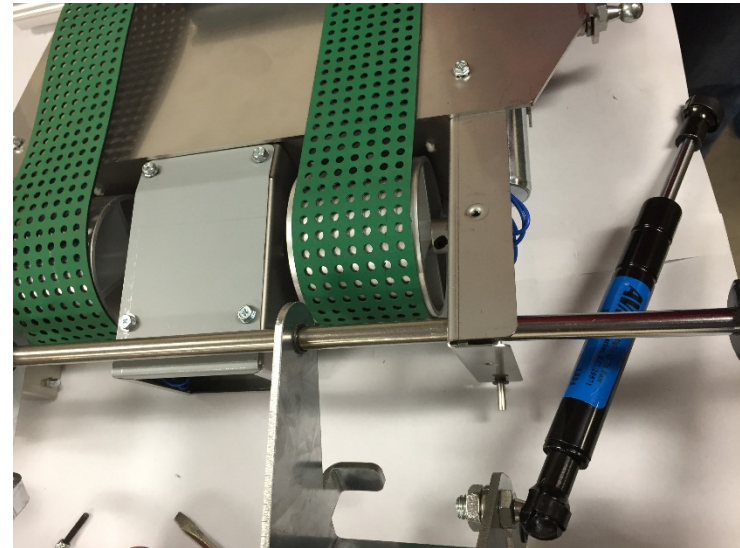

7. Do REP 4.6 [Idler Pulley Assembly Replacement](#) to remove the Idler Pulley Sub-Assembly (2).
8. Lift the Vacuum Drive Belt off the Idler Pulley and carefully slide around and off the Vacuum Stacker.

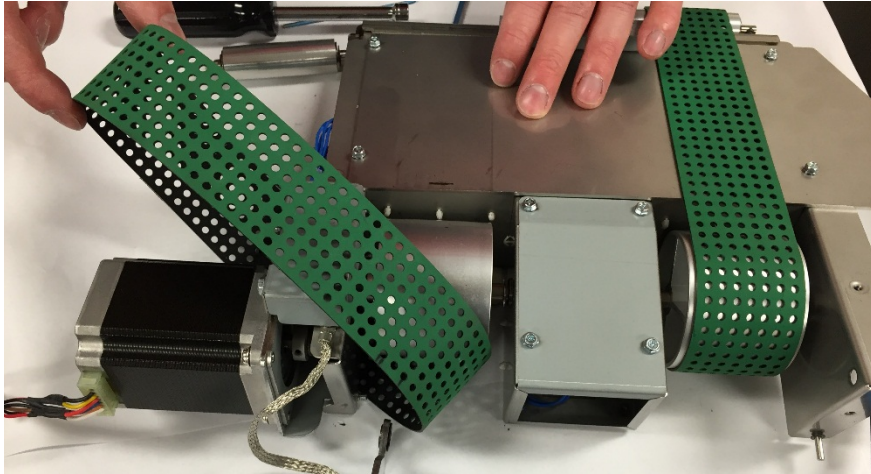

9. Repeat the process to remove the other Vacuum Drive Belt.

### Installation Procedure

1. Reverse the steps from the Removal Procedure.
2. Do REP 4.1 [Vacuum Stacker Module Replacement](#) to install the Vacuum Stacker.
3. Connect the Power Cord
4. Turn on the eWire.

## REP 4.9 Stacker Drive Belt Replacement

### PARTS LIST ON PL 5.15

Use this procedure to remove and install the Vacuum Stacker Drive Belt.

#### Removal Procedure

#### **WARNING**

**Do not perform repair activities with the power on or electrical power supplied to the machine. Some machine components contain dangerous electrical voltages that can result in electrical shock and possible serious injury. See Section 0, page vi for other languages.**

1. Switch power OFF to eWire.
2. Disconnect the Power Cord.
3. Do REP 4.1 [Vacuum Stacker Module Replacement](#) to remove the Vacuum Stacker.
4. Do REP 4.5 [Motor Replacement, Vacuum Stacker Drive \(M5\)](#) to remove the Vacuum Stacker Drive Motor.
5. Slide the Drive Belt off the Pulley and remove from the module.

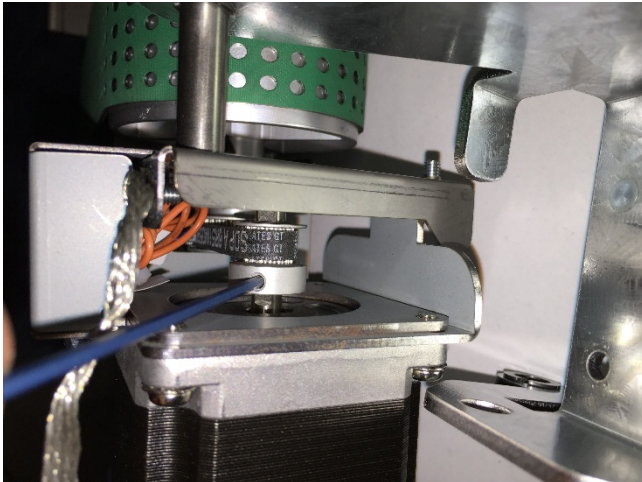

#### Installation Procedure

1. Place the new Belt around the Shaft Pulley and loosely wrap it around the Motor pulley.
2. Do REP 4.5 [Motor Replacement, Vacuum Stacker Drive \(M5\)](#) to install the Vacuum Stacker Motor.
3. Check the belt tension on the Drive Belt and adjust if necessary.
4. Ensure all Pulley set screws are tightened.
5. Do REP 4.1 [Vacuum Stacker Module Replacement](#) to replace the Vacuum Stacker.
6. Connect the Power Cord
7. Turn on the eWire.



## REP 4.10 Drag Finger Adhesive Grip Replacement

### PARTS LIST ON PL 5.15

Use this procedure to remove and install the Vacuum Stacker Drag Finger Adhesive.

#### Removal Procedure

#### WARNING

**Do not perform repair activities with the power on or electrical power supplied to the machine. Some machine components contain dangerous electrical voltages that can result in electrical shock and possible serious injury. See Section 0, page vi for other languages.**

1. Switch power OFF to eWire.
2. Disconnect the Power Cord.
3. Do REP 4.1 [Vacuum Stacker Module Replacement](#) to remove the Vacuum Stacker.
4. Using a flat head screwdriver or knife, carefully peel up one corner of the Drag Finger Adhesive Grip. Then remove the remaining material by peeling it away from the surface of the Vacuum Stacker.

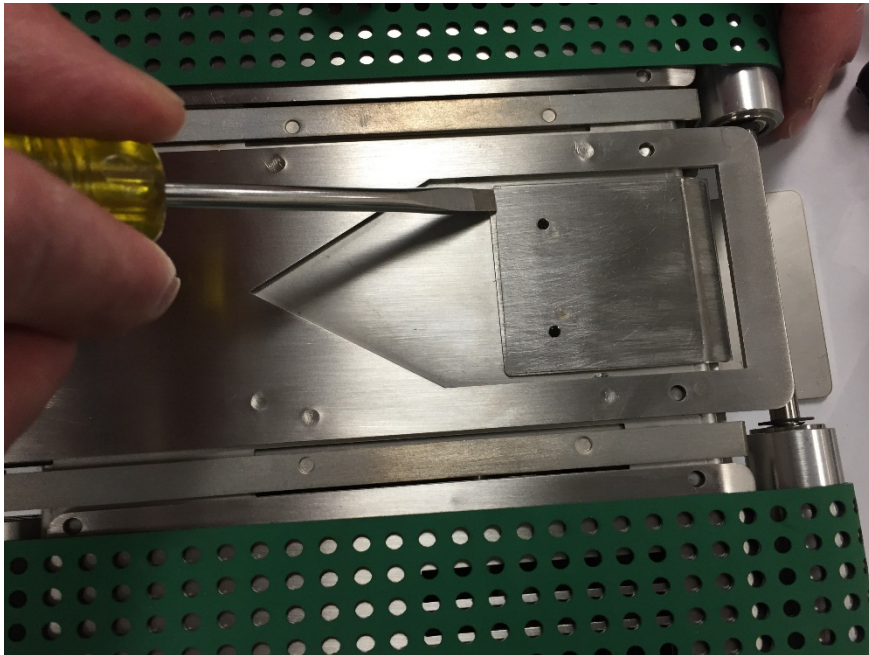

#### Installation Procedure

1. Clean the adhesion surface, removing all material left over from the previous Adhesive Grip part. Wipe the surface clean with a rag and alcohol.
2. Remove the paper backing from the adhesive side of the Adhesive Grip material.
3. Carefully Align the Drag Finger Adhesive Grip to the mating surface, using the outline from the previous material if possible.
4. Press the new Drag Finger Adhesive Grip to the material and press it down flat.
5. Do REP 4.1 [Vacuum Stacker Module Replacement](#) to replace the Vacuum Stacker.
6. Connect the Power Cord
7. Turn on the eWire.

## 5. Deflector Module

### REP 5.1 Deflector Module Replacement

#### PARTS LIST ON PL 5.16

Use this procedure to remove and install the Deflector Module

#### Removal Procedure

#### WARNING

**Do not perform repair activities with the power on or electrical power supplied to the machine. Some machine components contain dangerous electrical voltages that can result in electrical shock and possible serious injury. See Section 0, page vi for other languages.**

1. Switch power OFF to eWire.
2. Disconnect the Power Cord.
3. Raise the lid.
4. Disconnect the Deflector Cables by detaching the 3 cable headers.

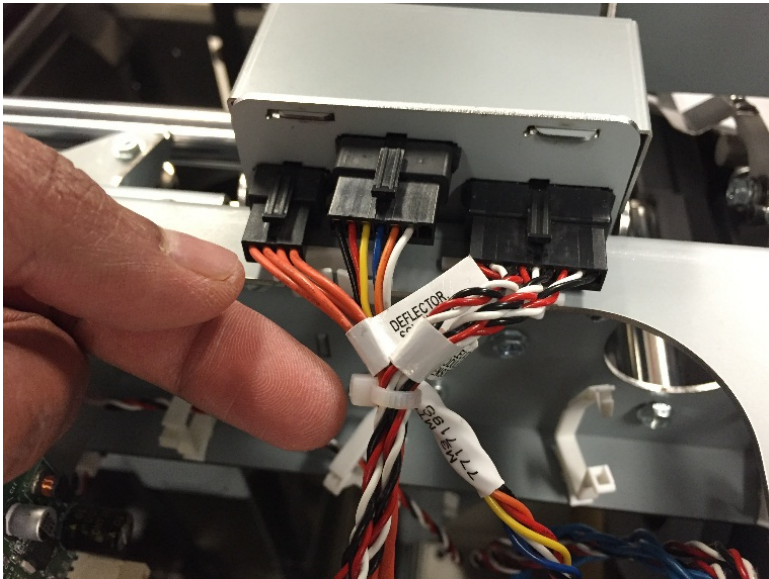

5. Remove the M4 Screws (2) from the front of the Deflector Module

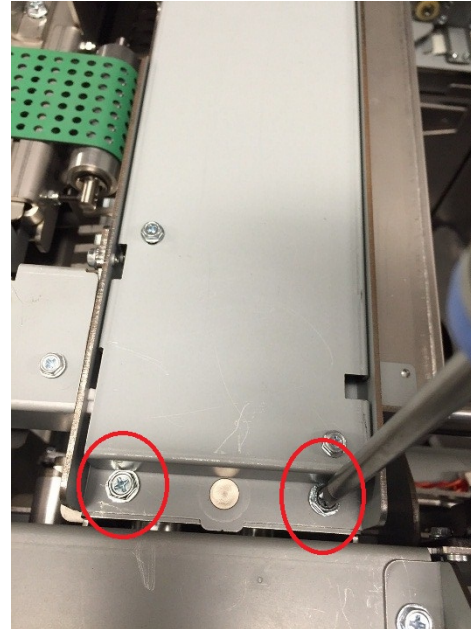

6. Remove the M3 Screw and remove the cable cover plate from the rear side of the Deflector

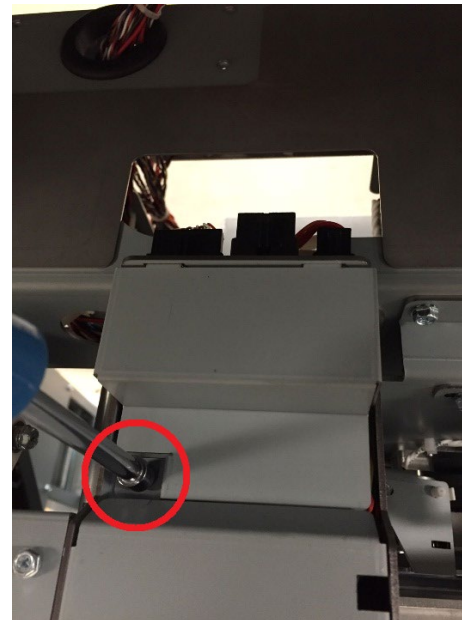

7. Remove the M4 Screws (2) from the back of the Deflector

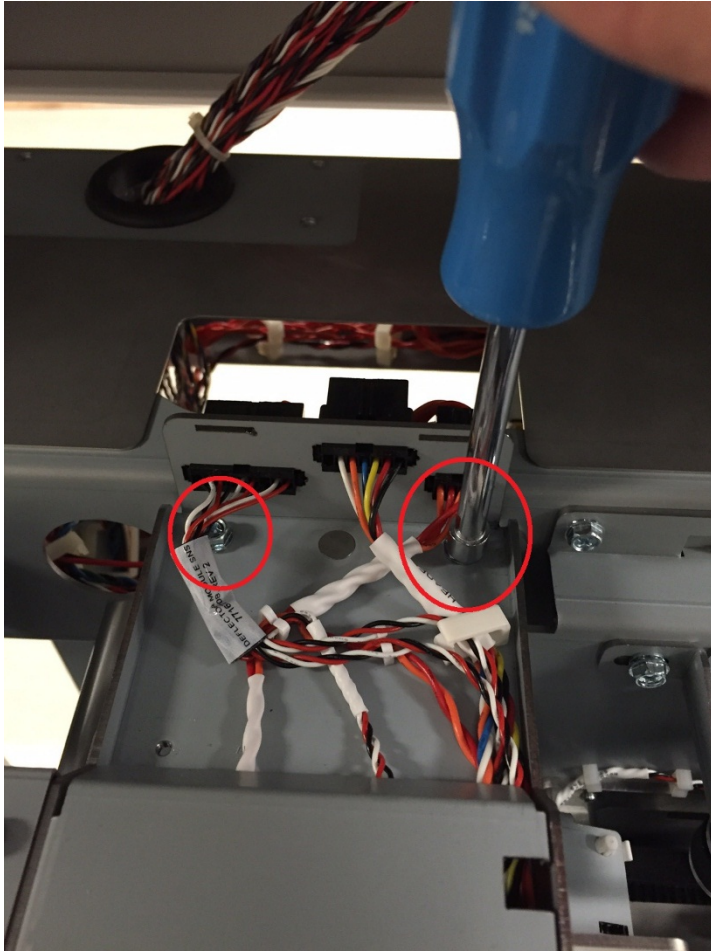

8. Carefully lift the Deflector out of the eWire to remove it.

### Installation Procedure

1. Place the Deflector Module onto the eWire. Use the pins on the bottom of the Deflector to align the module.
2. Reattach the Deflector Module to the Frame by securing the M4 Screws (4).
3. Reattach the deflector cable cover and secure it using the M3 Screw.
4. Reconnect the Deflector cables to the headers on the back of the Deflector.
5. Connect the Power Cord.
6. Power ON the eWire.

## REP 5.2 Sensor Replacement, Deflector Position S17

### PARTS LIST ON PL 5.16

Use this procedure to remove and install Deflector Position Sensor

#### **WARNING**

**Do not perform repair activities with the power on or electrical power supplied to the machine. Some machine components contain dangerous electrical voltages that can result in electrical shock and possible serious injury. See Section 0, page vi for other languages.**

#### **Removal Procedure**

1. Switch power OFF to eWire.
2. Disconnect the Power Cord.
3. Do REP 5.1 [Deflector Module Replacement](#) to remove the Deflector Module.
4. Locate the Deflector Position Sensor S17
5. Remove the Sensor Bracket by loosening the M3 Screws (2)

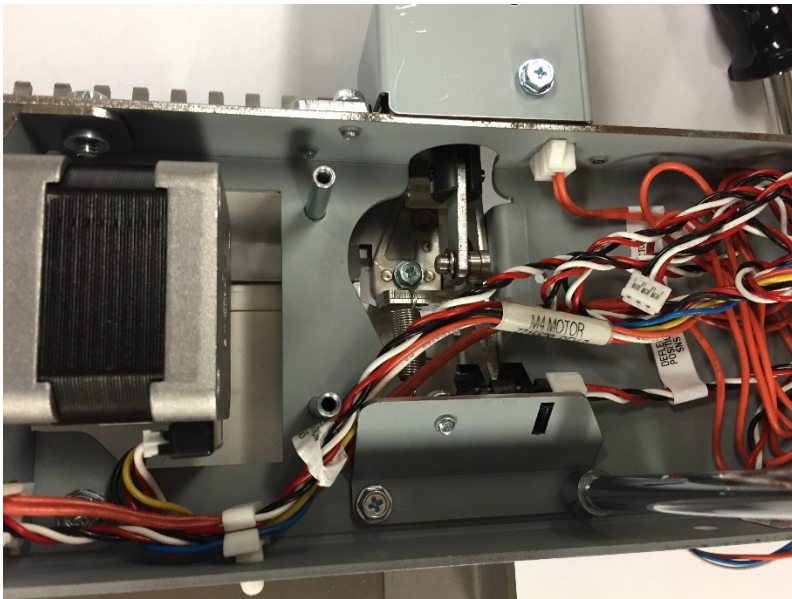

6. Disconnect the Sensor Cable
7. Remove the old Sensor by removing the M3 Screw (1)

#### **Installation Procedure**

1. Install the new Sensor into the Sensor Bracket. Use the cutout to align the sensor
2. Attach the Sensor Bracket to the Deflector.
3. Connect the Sensor Cable to the new Sensor.
4. Ensure that the sensor flag is aligned with the Sensor detection opening
5. Do REP 5.1 [Deflector Module Replacement](#) to Install the Deflector Module.
6. Connect the Power Cord.
7. Power ON the eWire.
8. Do GP 6.4 to verify sensor function.

## REP 5.3 Sensor Replacement, Bind Kick-Downs S2

### PARTS LIST ON PL 5.16

Use this procedure to remove and install Bind Kick-Downs Position Sensor

### WARNING

**Do not perform repair activities with the power on or electrical power supplied to the machine. Some machine components contain dangerous electrical voltages that can result in electrical shock and possible serious injury. See Section 0, page vi for other languages.**

### Removal Procedure

1. Switch power OFF to eWire.
2. Disconnect the Power Cord.
3. Do REP 5.1 [Deflector Module Replacement](#) to remove the Deflector Module.
4. Locate the Bind Kick-Downs Sensor S2. The sensor is located between the Deflector frame plate and the baffle plate.

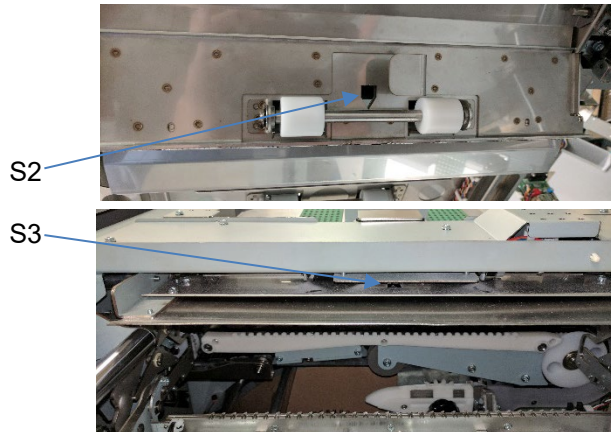

5. Disconnect the Sensor Cable.
6. Remove the Sensor Bracket by loosening the M3 Screws (2)
7. Remove the old Sensor by removing the M3 mounting screw.

### Installation Procedure

1. Install the new Sensor into the Sensor Bracket. Use the cutout to align the sensor.
2. Attach the Sensor Bracket to the Deflector.
3. Connect the Sensor Cable to the new Sensor.
4. Do REP 5.1 [Deflector Module Replacement](#) to Install the Deflector Module.
5. Connect the Power Cord.
6. Power ON the eWire.
7. Do GP 6.4 to verify sensor function.

## REP 5.4 Sensor Replacement, Bind Deflect S3

### PARTS LIST ON PL 5.16

Use this procedure to remove and install Deflector Bind Deflect Sensor

#### WARNING

**Do not perform repair activities with the power on or electrical power supplied to the machine. Some machine components contain dangerous electrical voltages that can result in electrical shock and possible serious injury. See Section 0, page vi for other languages.**

#### Removal Procedure

1. Switch power OFF to eWire.
2. Disconnect the Power Cord.
3. Do REP 5.1 [Deflector Module Replacement](#) to remove the Deflector Module.
4. Locate the Bind Deflect Sensor S3. The sensor is located in a cutout near the center of the Deflector Frame.

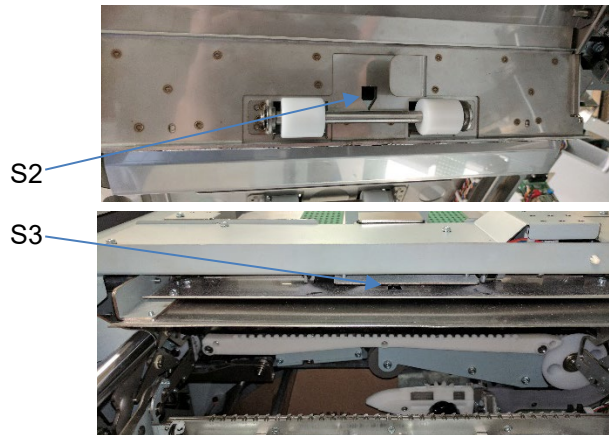

5. Disconnect the Sensor Cable.
6. Remove the Sensor Bracket by loosening the M3 Screws (2)
7. Remove the old Sensor by removing the M3 mounting screw.

#### Installation Procedure

1. Install the new Sensor into the Sensor Bracket. Use the cutout to align the sensor.
2. Attach the Sensor Bracket to the Deflector.
3. Connect the Sensor Cable to the new Sensor.
4. Do REP 5.1 [Deflector Module Replacement](#) to Install the Deflector Module.
5. Connect the Power Cord.
6. Power ON the eWire.
7. Do GP 6.3.2 to verify sensor function.

## REP 5.5 Bind Path Motor Replacement M3

### PARTS LIST ON PL 5.16

Use this procedure to remove and install Bind Path Motor

#### **WARNING**

**Do not perform repair activities with the power on or electrical power supplied to the machine. Some machine components contain dangerous electrical voltages that can result in electrical shock and possible serious injury. See Section 0, page vi for other languages.**

#### **Removal Procedure**

1. Switch power OFF to eWire.
2. Disconnect the Power Cord.
3. Do REP 5.1 [Deflector Module Replacement](#) to remove the Deflector Module.
4. Loosen the Set Screw on the Motor Pulley.
5. Disconnect the Motor Cable.

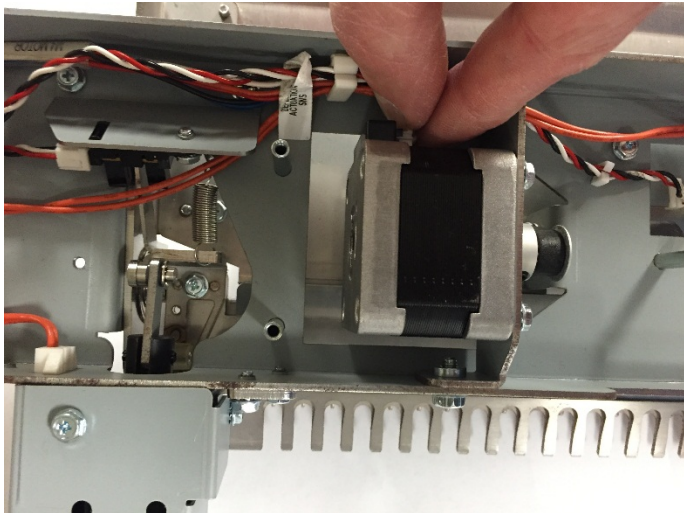

6. Disconnect the stepper motor by loosening the M3 Screws (4). Remove the Pulley from the Motor shaft and remove the old Motor.

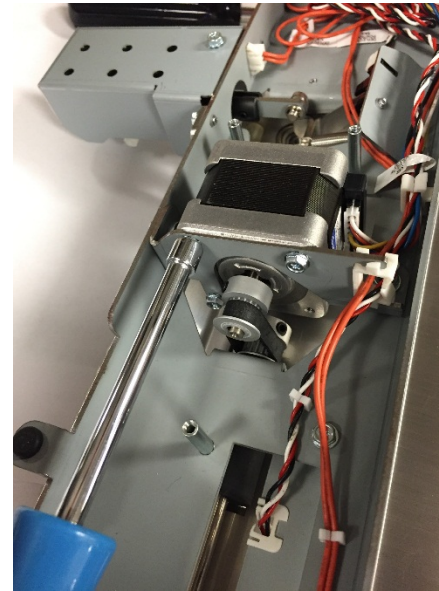

#### **Installation Procedure**

1. Position the motor in place on the Motor Bracket and slide the Pulley onto the Motor shaft.
2. Tighten the M3 Screws (4) to attach the motor.
3. Tighten the set screw to secure the Pulley
4. Do REP 5.1 [Deflector Module Replacement](#) to Install the Deflector Module.
5. Connect the Power Cord.
6. Power ON the eWire.

## REP 5.6 Deflector Module Timing Belt Replacement

### PARTS LIST ON PL 5.16

Use this procedure to remove and install Deflector Timing Belt

#### **WARNING**

**Do not perform repair activities with the power on or electrical power supplied to the machine. Some machine components contain dangerous electrical voltages that can result in electrical shock and possible serious injury. See Section 0, page vi for other languages.**

#### **Removal Procedure**

1. Switch power OFF to eWire.
2. Disconnect the Power Cord.
3. Do REP 5.1 [Deflector Module Replacement](#) to remove the Deflector Module.
4. Do REP 5.5 [Bind Path Motor Replacement](#) to remove the Motor.
5. Slide the old Timing Belt off of the Drive Pulley and remove it.

#### **Installation Procedure**

1. Loosely slide the new Timing Belt around the Drive Pulley
2. Do [REP 5.5](#) to reinstall the Motor.
3. Check the Belt tension. If necessary, increase or decrease tension in the Belt by reseating the Motor.
4. Do REP 5.1 [Deflector Module Replacement](#) to Install the Deflector Module.
5. Connect the Power Cord.
6. Power ON the eWire.



## REP 5.7 Deflector Solenoid Replacement L5

### PARTS LIST ON PL 5.16

Use this procedure to remove and install the Deflector Solenoid(s). Note that the same procedure can be used to remove the Solenoids on each side of the Deflector Module.

#### WARNING

**Do not perform repair activities with the power on or electrical power supplied to the machine. Some machine components contain dangerous electrical voltages that can result in electrical shock and possible serious injury. See Section 0, page vi for other languages.**

#### Removal Procedure

1. Switch power OFF to eWire.
2. Disconnect the Power Cord.
3. Do REP 5.1 [Deflector Module Replacement](#) to remove the Deflector Module.
4. Remove the Solenoid cover by removing the M3 Screws (2)

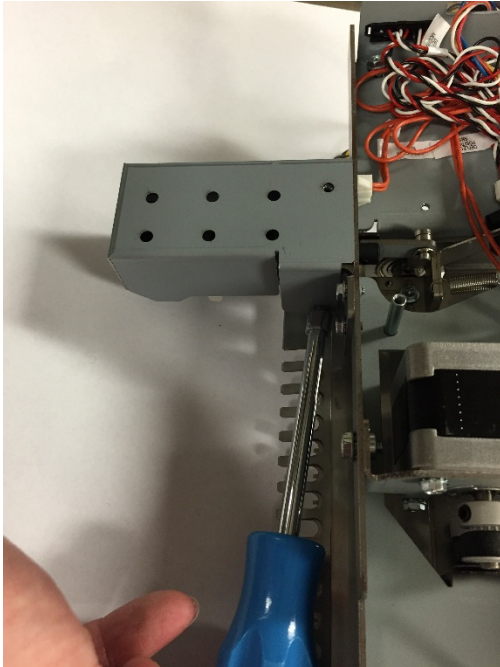

5. Remove the Solenoid Mounting Bracket by removing the M3 Screws (3)

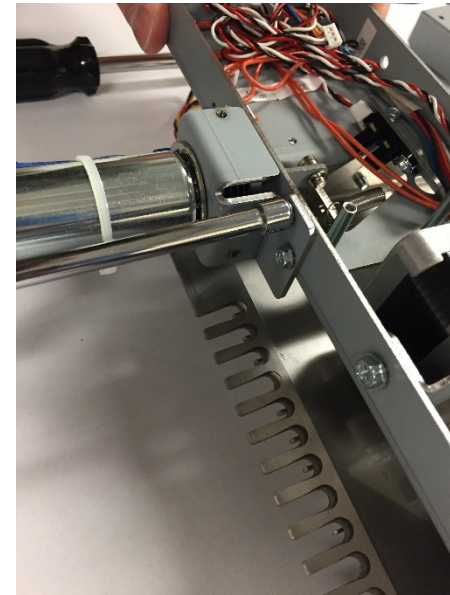

6. Disconnect the Solenoid cable at the appropriate cable header.

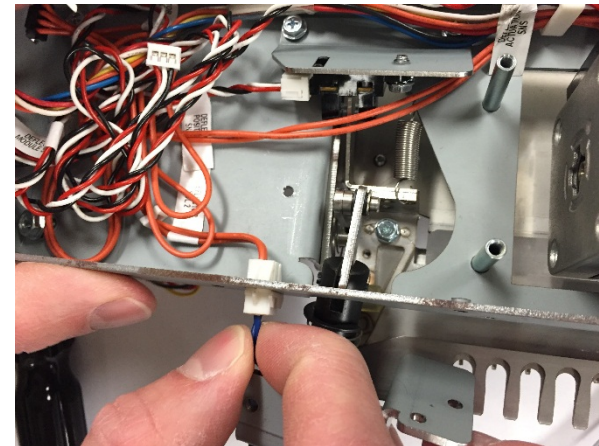

- Using a flat head screwdriver, remove the E-Ring securing the Solenoid Linkage Pin.

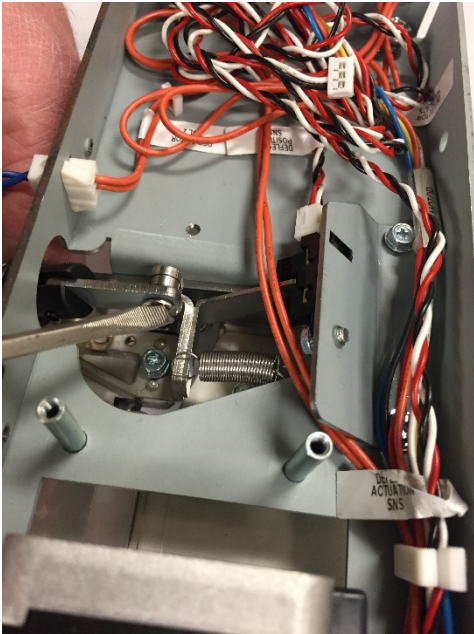

- Using an adjustable wrench, loosen the nut securing the Solenoid to the Solenoid Mounting Bracket and remove the Solenoid linkage.

### Installation Procedure

- Install the Solenoid to the Solenoid Mounting Bracket by tightening the nut. Note the orientation of the linkage assembly relative to the link pin on the Deflector.
- Position the Solenoid Bracket in place and connect the Solenoid Linkage to the Link Pin using the E-Ring.
- Tighten the M3 Screws (3) to attach the Solenoid Mount Bracket to the Deflector Frame.
- Connect the Solenoid Cable.
- Install the Solenoid Cover Plate by securing the M3 Screws (3).
- Do REP 5.1 [Deflector Module Replacement](#) to Install the Deflector Module.
- Connect the Power Cord.
- Power ON the eWire.

## REP 5.8 Deflector Springs Replacement

### PARTS LIST ON PL 5.16

Use this procedure to remove and install Extension Springs on the Deflector. Note that the same procedure can be used for springs on each side of the Deflector.

### WARNING

**Do not perform repair activities with the power on or electrical power supplied to the machine. Some machine components contain dangerous electrical voltages that can result in electrical shock and possible serious injury. See Section 0, page vi for other languages.**

### Removal Procedure

1. Switch power OFF to eWire.
2. Disconnect the Power Cord.
3. Do REP 5.1 [Deflector Module Replacement](#) to remove the Deflector Module.
4. Locate the appropriate Deflector Springs.

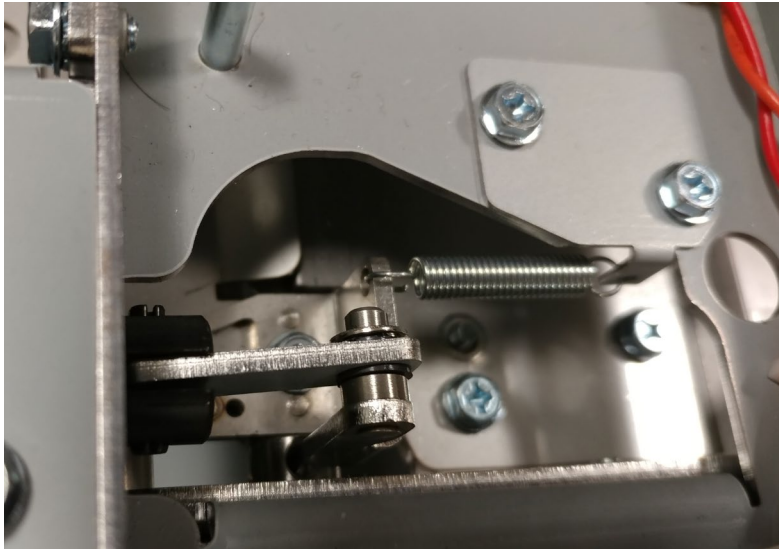

5. Remove the spring by unhooking it from the mounting holes on each end. If necessary, loosen the M3 Screws (2) on the Spring Bracket.

### Installation Procedure

1. Attach one end of the Deflector Spring to the hole on the Spring Bracket and attach the other end to the hole on the Kickdown Linkage.
2. Secure the Screws on the Spring Bracket.
3. Do REP 5.1 [Deflector Module Replacement](#) to Install the Deflector Module.
4. Connect the Power Cord.
5. Power ON the eWire.

## REP 5.9 Deflector Drive Roller Assembly Replacement

### PARTS LIST ON PL 5.16

Use this procedure to remove and install the Deflector Drive Roller Assembly, Nip N8.

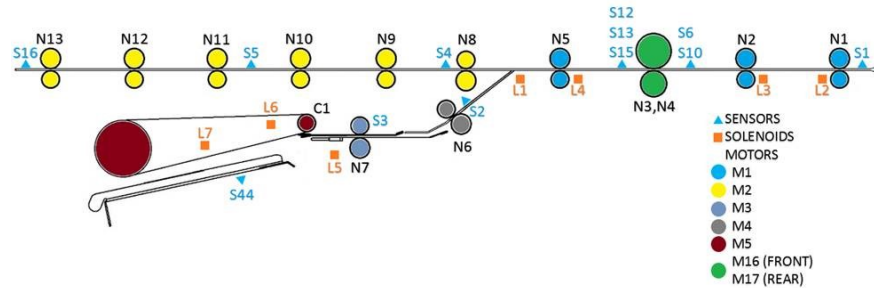

### WARNING

**Do not perform repair activities with the power on or electrical power supplied to the machine. Some machine components contain dangerous electrical voltages that can result in electrical shock and possible serious injury. See Section 0, page vi for other languages.**

### Removal Procedure

1. Switch power OFF to eWire.
2. Disconnect the Power Cord.
3. Do REP 5.1 [Deflector Module Replacement](#) to remove the Deflector Module.
4. Remove the Outer Baffle Assembly by removing the M3 Screws (4).
5. Remove the Inner Baffle Assembly by removing the M3 Screws (4). Set aside the right and left Baffle Mounting Brackets, noting the orientation for re-assembly.
6. Do REP 5.5 [Bind Path Motor Replacement M3](#) to remove the Motor (M3).
7. Loosen the set screw on the Drive Shaft Pulley, and remove the Pulley and Timing Belt.
8. Using a flat head screwdriver, remove the E-Ring and Washer from both sides of the Drive Roller Assembly.
9. Remove the Bearings from each side of the Drive Roller Assembly.
10. Remove the Drive Roller Assembly.

### Installation Procedure

1. Position the new Drive Roller Assembly into the brackets on the Deflector Frame and install the Bearings.
2. Secure the Drive Roller Assembly by installing Washers and E-Rings to each side.
3. Slide the Drive Pulley onto the end of the Drive Roller Shaft and secure using the set screw.
4. Do REP 5.5 [Bind Path Motor Replacement M3](#) to install the Motor.
5. Reverse the steps from the Removal Procedure to install the Inner Baffle and Outer Baffle.
6. Do REP 5.1 [Deflector Module Replacement](#) to Install the Deflector Module.
7. Connect the Power Cord.
8. Power ON the eWire.

## REP 5.10 Deflector Idler Roller Assembly Replacement

### PARTS LIST ON PL 5.16

Use this procedure to remove and install the Deflector Idler Roller Assembly, Nip N8.

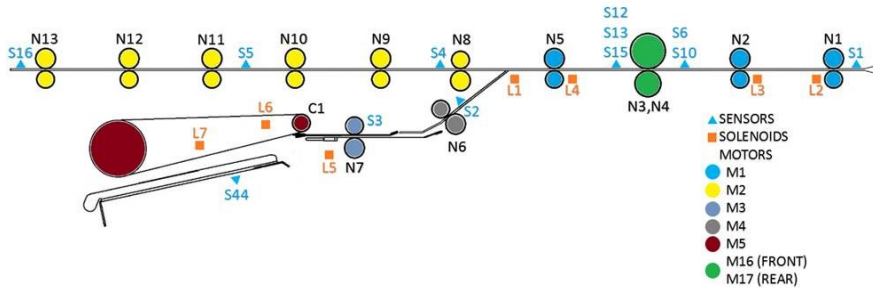

### WARNING

Do not perform repair activities with the power on or electrical power supplied to the machine. Some machine components contain dangerous electrical voltages that can result in electrical shock and possible serious injury. See Section 0, page vi for other languages.

### Removal Procedure

1. Switch power OFF to eWire.
2. Disconnect the Power Cord.
3. Do REP 5.1 [Deflector Module Replacement](#) to remove the Deflector Module.

4. Lift the Extension Spring (2) up off the Bearing Housing (2) at each end of the Idler Roller Shaft. Unhook the ends of the extension spring from the Bushing Forks.

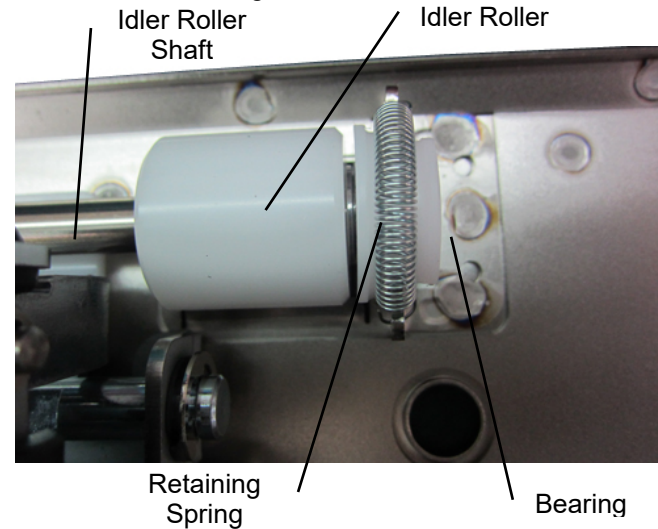

5. Remove the Idler Roller with the Bearing Housings (2) from the Bushing Forks.

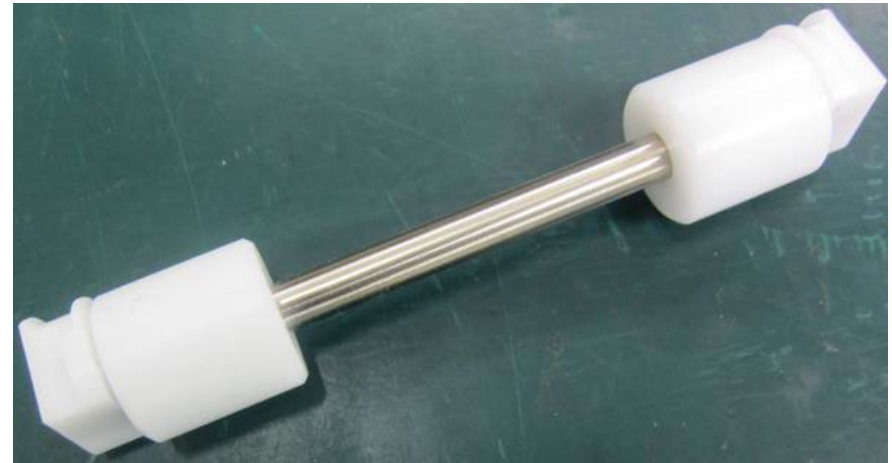

## Installation Procedure

1. Place the new Idler Roller with Bearing Housings into the Bushing Forks.
2. Make sure the flat surface of the bushing aligns in the fork.
3. Rollers are non-directional so it does not matter which end goes in each fork.
4. After the assembly is in place, gently pull the assembly outward and release to ensure it moves freely in the fork.
5. Place the Extension Spring (2) over the Bearing Housings (2).
6. Place the hooks on the ends of the Extension Springs (2) on the notches at the top of the Bushing Forks (2).
7. Do REP 5.1 [Deflector Module Replacement](#) to install the Deflector Module.
8. Connect the Power Cord.
9. Power ON the eWire.

## 6. Closer Module



**Hand Crush!**  
Crush hand if placed in jaws.  
Do not place fingers in closer jaws.



**Moving Gears!**  
Crush fingers if placed in gears.  
Keep clothing and body parts away from gears.

### REP 6.1 Closer Module Replacement

#### PARTS LIST ON PL 5.19

Use this procedure to remove and install the Closer Module

#### Removal Procedure

#### **WARNING**

**Do not perform repair activities with the power on or electrical power supplied to the machine. Some machine components contain dangerous electrical voltages that can result in electrical shock and possible serious injury. See Section 0, page vi for other languages.**

1. Switch power OFF to eWire.
2. Disconnect the Power Cord.
3. Raise the Top Cover.

4. Remove the Cable Access Cover by removing the M3 Screws (2).

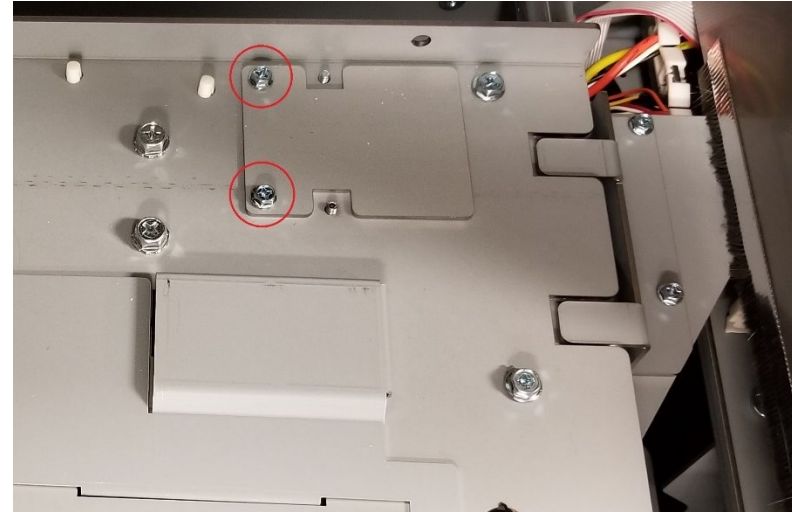

5. Disconnect the Flat Mylar Closer Cable by pushing up on the locking tab and pulling gently toward the front of the machine. The cable should detach easily, do not exert excessive force or it may become damaged.

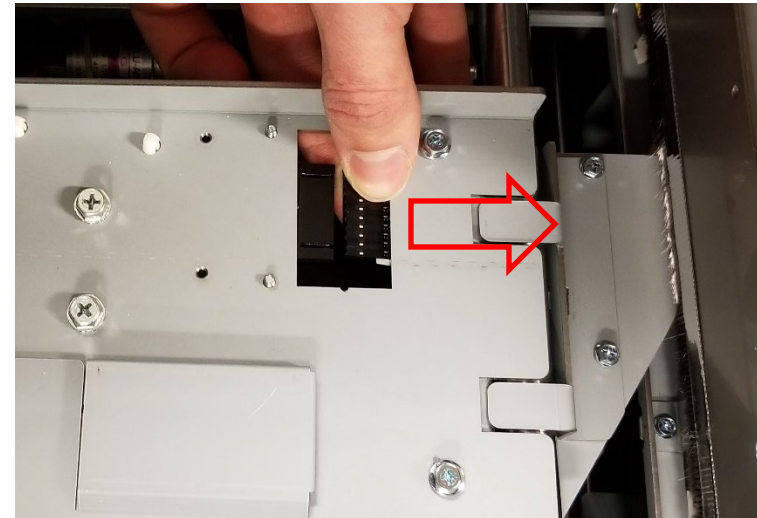

The photo below shows the locking tab from the underside of the Closer Module. Removing the clamp holding the header can ease the unlocking of this connection.

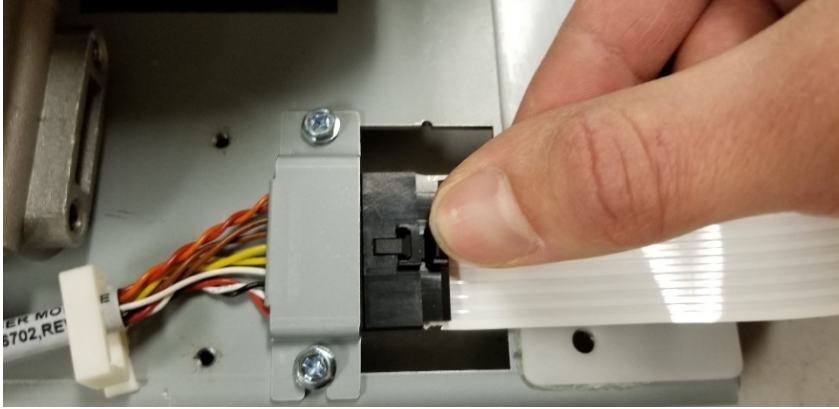

6. Remove the M4 Screws (4) securing the Closer Module.



7. Using both hands, lift the Closer Module out of the machine. Take care as this module is quite heavy.

## Installation Procedure

1. Position the Closer Module so that the two pins on the rear drop into the holes in the Tube Bearing Assembly. Push on the module in the direction shown in the location shown. The Closer Module should move linearly and should NOT rotate. If the module rotates then check that the pins are properly seated in their holes.

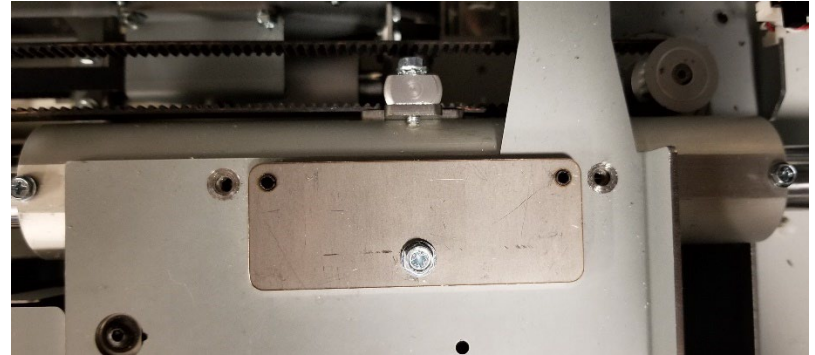

2. Reinstall the M4 Screws (4)
3. Re-attach the Flat Mylar Closer Cable. Take care to push in firmly so that the locking tab engages.
4. Reinstall the Cable Access Cover and the M3 Screws (2) that hold it.
5. Connect the Power Cord.
6. Power ON the eWire.



## REP 6.2 Closer Encoder Sensor Replacement S48

### PARTS LIST ON PL 5.19

Use this procedure to remove and install the S48 Closer Encoder sensor.

#### Removal Procedure

#### WARNING

**Do not perform repair activities with the power on or electrical power supplied to the machine. Some machine components contain dangerous electrical voltages that can result in electrical shock and possible serious injury. See Section 0, page vi for other languages.**

1. Switch power OFF to eWire.
2. Disconnect the Power Cord.
3. Do REP 6.4 [Closer Motor Replacement M20](#) to remove the Closer Module and Closer Motor.
4. Do GP 6.4 to locate the S48 Closer Encoder sensor.
5. Remove the cable from the header on the sensor and remove the Sensor Bracket by removing the M3 Screw.

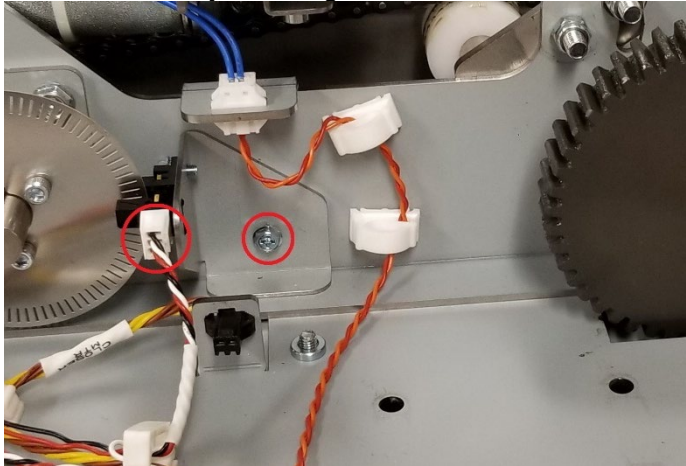

6. Remove the M3 Screw to remove the sensor from the Sensor Bracket.

#### Installation Procedure

1. Attach the new sensor to the Sensor Bracket using the M3 Screw. Use the cutout in the bracket to align the sensor. Take care that the underside of the sensor is sitting flush against the bracket.
2. Secure the Sensor Bracket into place by tightening the M4 Screw. Ensure that the Encoder is centered with the Sensor.
3. Connect the Sensor cable.
4. Do Rep 6.4 [Closer Motor Replacement M20](#) to reinstall the Closer Motor and Closer Module.
5. Connect the Power Cord.
6. Power ON the eWire.

## REP 6.3 Closer Full Open Sensor Replacement S47

### PARTS LIST ON PL 5.19

Use this procedure to remove and install the S47 Closer Full Open sensor

#### Removal Procedure

#### WARNING

**Do not perform repair activities with the power on or electrical power supplied to the machine. Some machine components contain dangerous electrical voltages that can result in electrical shock and possible serious injury. See Section 0, page vi for other languages.**

1. Switch power OFF to eWire.
2. Disconnect the Power Cord.
3. Do REP 6.4 [Closer Motor Replacement M20](#) to remove the Closer Module and Closer Motor.
4. Do GP 6.4 to locate the S47 Closer Full Open sensor.
5. Remove the M3 Screw to remove the sensor and disconnect the cable from the header.

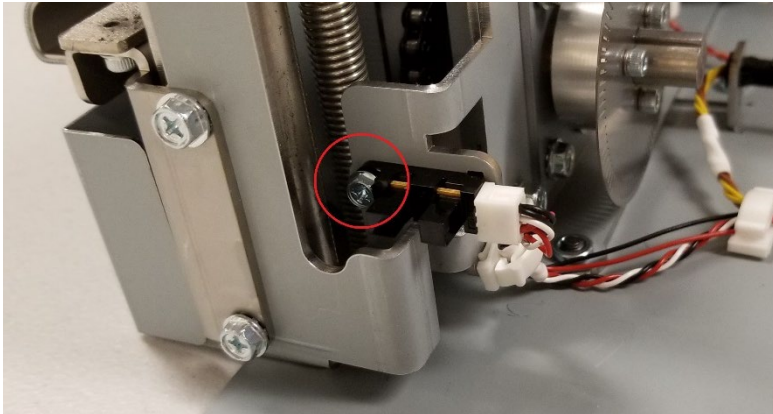

#### Installation Procedure

1. Install the new sensor using the M3 Screw. Use the cutout to align the sensor. Take care that the underside of the sensor is sitting flush against the bracket.
2. Connect the sensor cable.
3. Do Rep 6.4 [Closer Motor Replacement M20](#) to reinstall the Closer Motor and Closer Module.
4. Connect the Power Cord.
5. Power ON the eWire.

## REP 6.4 Closer Motor Replacement M20

### PARTS LIST ON PL 5.19

Use this procedure to remove and install the Closer Motor M20

#### Removal Procedure

#### WARNING

**Do not perform repair activities with the power on or electrical power supplied to the machine. Some machine components contain dangerous electrical voltages that can result in electrical shock and possible serious injury. See Section 0, page vi for other languages.**

1. Switch power OFF to eWire.
2. Disconnect the Power Cord.
3. Do REP 6.1 [Closer Module Replacement](#) to remove the Closer Module.
4. Undo the cable saddles and disconnect the Motor Cable at the header.

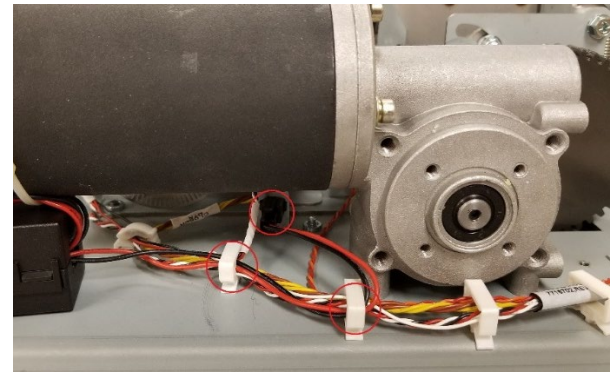

5. Disconnect the Closer Motor by removing the M5 Screws (4).

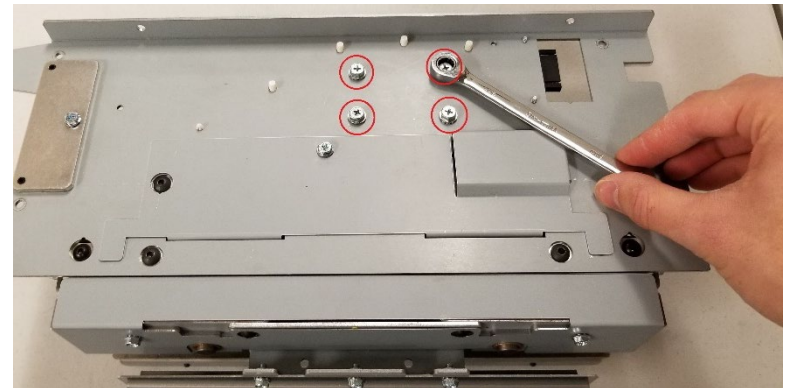

6. Remove the Small Gear from the Motor by loosening the M4 Set Screw and sliding the Gear off the shaft.

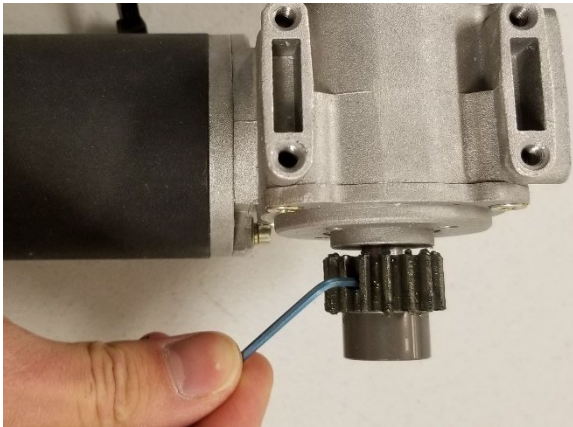

### Installation Procedure

1. Install the Small Gear onto the shaft of the new motor. Install the M4 Set Screw, but do not tighten it yet.
2. Install the Closer Motor into the Closer Module using the M5 Screws (4).
3. Check the alignment of the Small Gear to the Large Gear. The faces of both gears should be coplanar. Adjust the Small Gear as needed then tighten the M4 Set Screw to secure it.

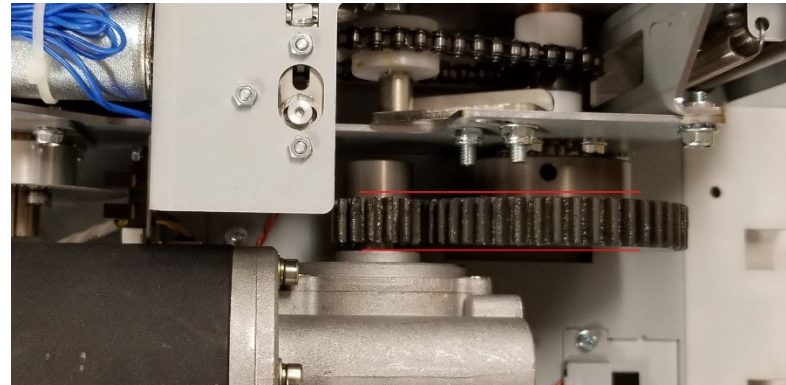

4. Connect the Motor Cable and secure it with the wire saddles.
5. Do Rep 6.1 [Closer Module Replacement](#) to Install the Closer Module.
6. Connect the Power Cord.
7. Power ON the eWire.

## REP 6.5 Closer Jaw Insert Replacement

### PARTS LIST ON PL 5.19

Use this procedure to remove and install the Closer Jaw Inserts.

#### Removal Procedure

#### WARNING

**Do not perform repair activities with the power on or electrical power supplied to the machine. Some machine components contain dangerous electrical voltages that can result in electrical shock and possible serious injury. See Section 0, page vi for other languages.**

1. Switch power OFF to eWire.
2. Disconnect the Power Cord.
3. Do REP 6.1 [Closer Module Replacement](#) to remove the Closer Module.
4. Remove the Front Closer Cover by removing the M4 Screws (2).

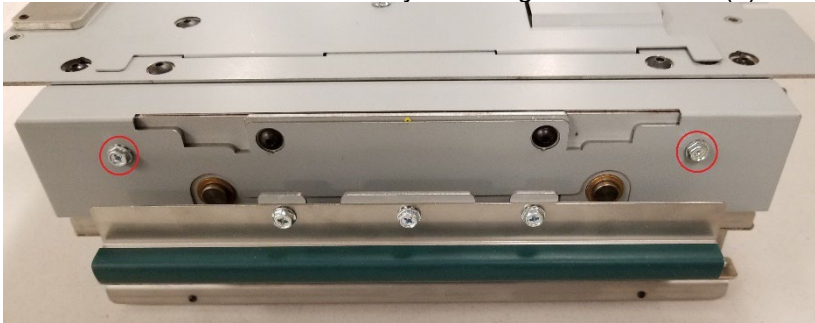

5. Remove the M3 Screws (2) holding the upper insert.

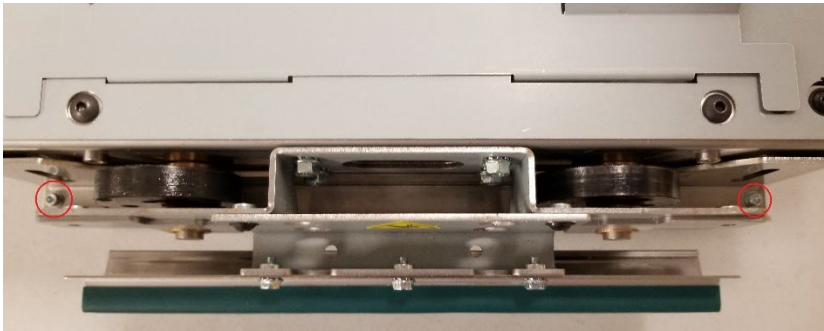

6. Remove the M3 Screws (2) holding the lower insert.

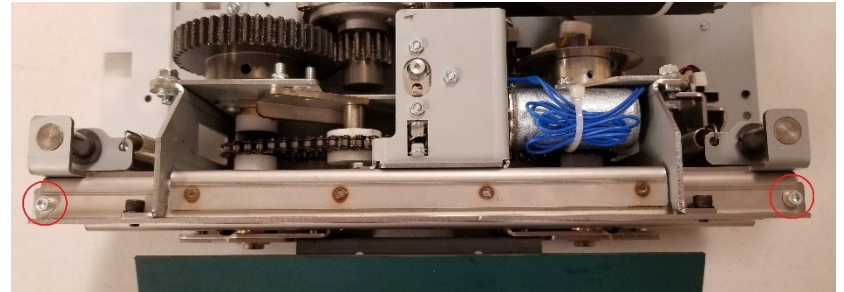

#### Installation Procedure

1. Position the Jaw Inserts in place and secure them using the M3 Screws (4). Make sure to reinstall the washer under the head of each screw.
2. Reinstall the Front Closer Cover with the M4 Screws (2).
3. Do REP 6.1 [Closer Module Replacement](#) to install the Closer Module.
4. Connect the Power Cord.
5. Power ON the eWire.

## REP 6.6 Closer Spring Replacement

### PARTS LIST ON PL 5.19

Use this procedure to remove and install the Closer Extension Springs. Note that the same procedure can be used for springs on each side of the Closer.

#### Removal Procedure

### WARNING

**Do not perform repair activities with the power on or electrical power supplied to the machine. Some machine components contain dangerous electrical voltages that can result in electrical shock and possible serious injury. See Section 0, page vi for other languages.**

1. Switch power OFF to eWire.
2. Disconnect the Power Cord.
3. Do REP 6.1 [Closer Module Replacement](#) to remove the Closer.
4. Remove the Closer Top Cover by removing the M4 Screw.

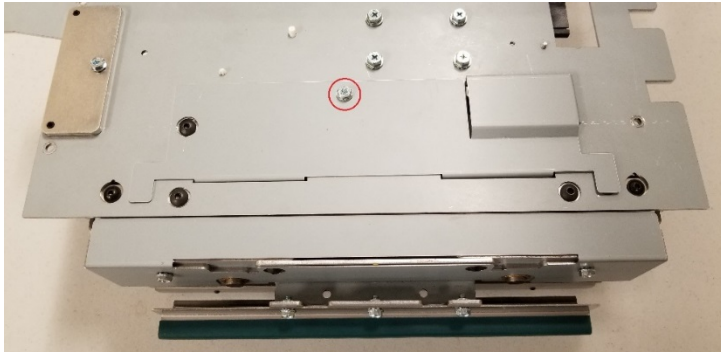

5. Remove the Extension Springs by disconnecting each end with a spring hook. The top of the spring can be accessed from the window in the upper plate.



#### Installation Procedure

1. Position the Extension Springs in the Closer and attach each end to the corresponding mounting holes.
2. Reinstall the Closer Top Cover with the M4 Screw.
3. Do REP 6.1 [Closer Module Replacement](#) to install the Closer Module.
4. Connect the Power Cord.
5. Power ON the eWire.

## REP 6.7 Closer Release Solenoid Replacement

### PARTS LIST ON PL 5.19

Use this procedure to remove and install the Closer Release Solenoid.

#### Removal Procedure

#### WARNING

**Do not perform repair activities with the power on or electrical power supplied to the machine. Some machine components contain dangerous electrical voltages that can result in electrical shock and possible serious injury. See Section 0, page vi for other languages.**

1. Switch power OFF to eWire.
2. Disconnect the Power Cord.
3. Do REP 6.1 [Closer Module Replacement](#) to remove the Closer.
4. Using an Allen wrench, remove the Shoulder Screws (3) securing the Ejector Plate to the Closer Ejector Bracket.
5. Remove the Compression Spring from the Closer Ejector Plate.
6. Remove the Closer Ejector Plate from the Closer by pushing it forward through the Closer Jaws.
7. Disconnect the Solenoid cable from the appropriate cable header.
8. Remove the Ejector Bracket from the Closer by loosening the M4 Screws (2).
9. Using an adjustable wrench, remove the Solenoid from the Ejector Bracket.

#### Installation Procedure

1. Reverse the steps from the removal procedure.
2. Do REP 6.1 [Closer Module Replacement](#) to install the Closer Module.
3. Connect the Power Cord.
4. Power ON the eWire.

## REP 6.8 Closer Chain Replacement Procedure

Use this procedure to remove and install the Closer Chain.

#### Removal Procedure

#### WARNING

**Do not perform repair activities with the power on or electrical power supplied to the machine. Some machine components contain dangerous electrical voltages that can result in electrical shock and possible serious injury. See Section 0, page vi for other languages.**

1. Switch power OFF to eWire.
2. Disconnect the Power Cord.
3. Do REP 6.1 [Closer Module Replacement](#) to remove the Closer.
4. Do REP 6.4 [Closer Motor Replacement](#) to remove the Motor
5. Place the closer upside down on a work surface.
6. Remove the tensioner assembly by removing the screws (2) securing it to the Closer.

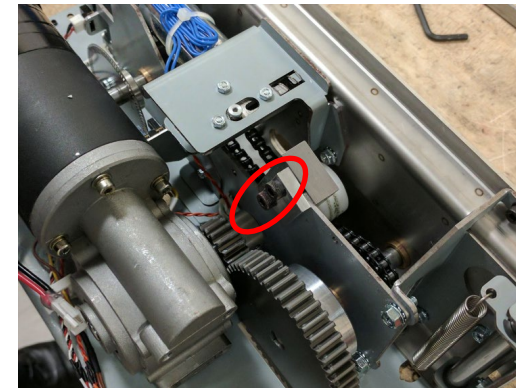

7. Rotate the chain until the master link is accessible.

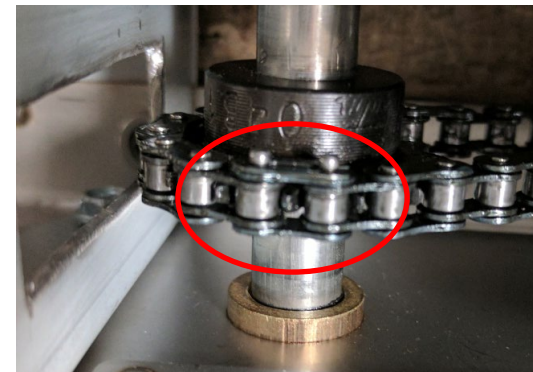

- Remove the master link by first removing the clip, then the outer plate, followed by the pin link.

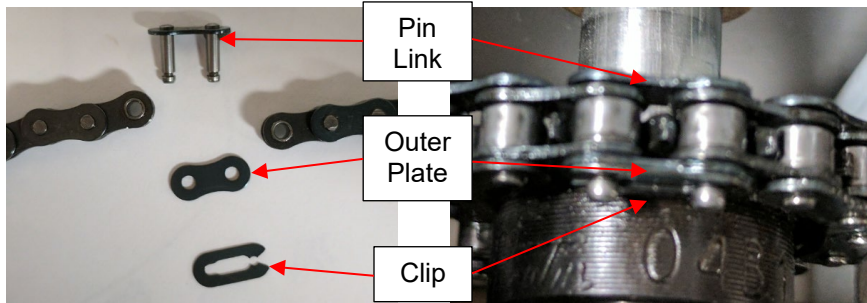

- Wrap the new length of chain around the sprockets and place it on the teeth so that the chain is tight on the bottom and loose on the top (in the closers current upside down orientation).
- Install the master link by reversing the steps in step 8.
- Reinstall the tensioner assembly. Position it so that the chain has approximately 5mm of give.
- Do REP 6.1 [Closer Module Replacement](#) to install the Closer Module.
- Connect the Power Cord.
- Power ON the eWire.
- Run sample books and examine the roundness of the closed elements. Refer to ADJ

## REP 6.9 Disk Encoder Replacement

Use this procedure to remove and install the Disk Encoder.

### Removal Procedure

#### **WARNING**

**Do not perform repair activities with the power on or electrical power supplied to the machine. Some machine components contain dangerous electrical voltages that can result in electrical shock and possible serious injury. See Section 0, page vi for other languages.**

- Switch power OFF to eWire.
- Disconnect the Power Cord.
- Do REP 6.4 [Closer Motor Replacement](#) to remove the Closer Motor.
- Place the closer upside down on a work surface.
- Do REP 6.3 to remove the S47 sensor
- Using a 2.5mm hex key remove the 3 screws

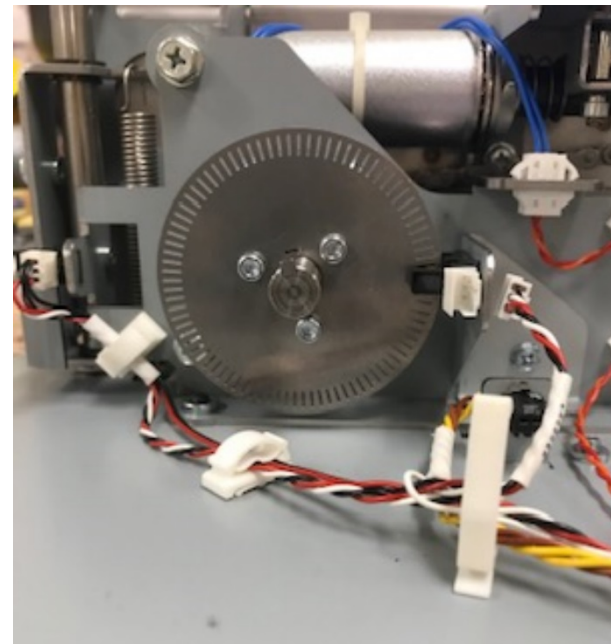

## Installation Procedure

1. Reverse the steps from the removal procedure.
2. Do REP 6.3 to replace the S47 sensor
3. Do REP 6.1 [Closer Module Replacement](#) to install the Closer Module.
4. Connect the Power Cord.
5. Power ON the eWire.

## 7. Tappers

### REP 7.1 Front Tapper Assembly Replacement PARTS LIST ON PL 5.17

Use this procedure to remove and replace the front Tapper Assembly.

#### Removal Procedure

#### **WARNING**

**Do not perform repair activities with the power on or electrical power supplied to the machine. Some machine components contain dangerous electrical voltages that can result in electrical shock and possible serious injury. See Section 0, page vi for other languages.**

1. Turn off Power to the eWire.
2. Disconnect the Power Cord.
3. Raise the Lid.
4. Do REP 1.8 [Front Cover Replacement](#) to remove the Front Cover.
5. Locate the Front Tapper Assembly.
6. Disconnect the Tapper Sensor Cable and Tapper Motor Cable from the corresponding headers.

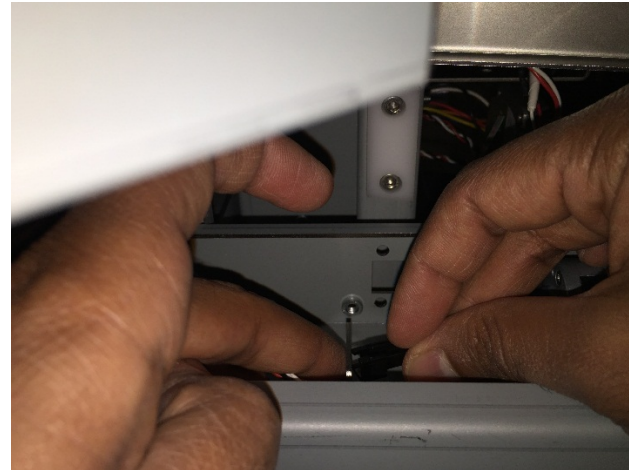



7. Remove the M4 screws (2) securing the Tapper to the eWire Frame

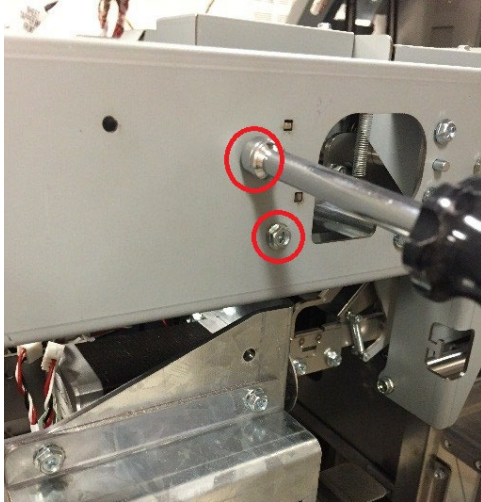

8. Carefully Remove the Tapper Assembly from the eWire

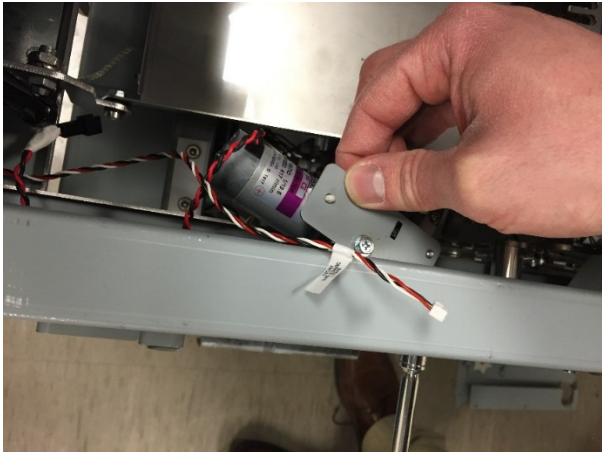

#### Installation Procedure

1. Place the Tapper Assembly into place on the eWire Frame. Two tabs are used to align the Front Tapper Assembly.
2. Secure the Front Tapper with the M4 Screws (2)
3. Connect the Sensor Cable and Motor Cable.
4. Do REP 1.1 [Top Cover Replacement](#) to replace the Front Cover.
5. Connect the Power Cable
6. Turn power ON to the eWire.

#### REP 7.2 Tapper Motor Replacement M6 & M7

##### PARTS LIST ON PL 5.17

Use this procedure to remove and install the Motor on the Front Tapper Assembly, Motor M6. Note: The same procedure can be used to replace Motor M7 on the Rear Tapper Assembly.

##### Removal Procedure

#### WARNING

**Do not perform repair activities with the power on or electrical power supplied to the machine. Some machine components contain dangerous electrical voltages that can result in electrical shock and possible serious injury. See Section 0, page vi for other languages.**

1. Switch power OFF to eWire.
2. Disconnect the Power Cord.
3. Do REP 7.1 [Front Tapper Assembly Replacement](#) to remove the Front Tapper Assembly.
4. Disconnect the Front Tapper Spring by lifting it off the notch on the Tapper Frame.
5. Loosen the Set screw securing the Tapper hub to the Motor shaft.

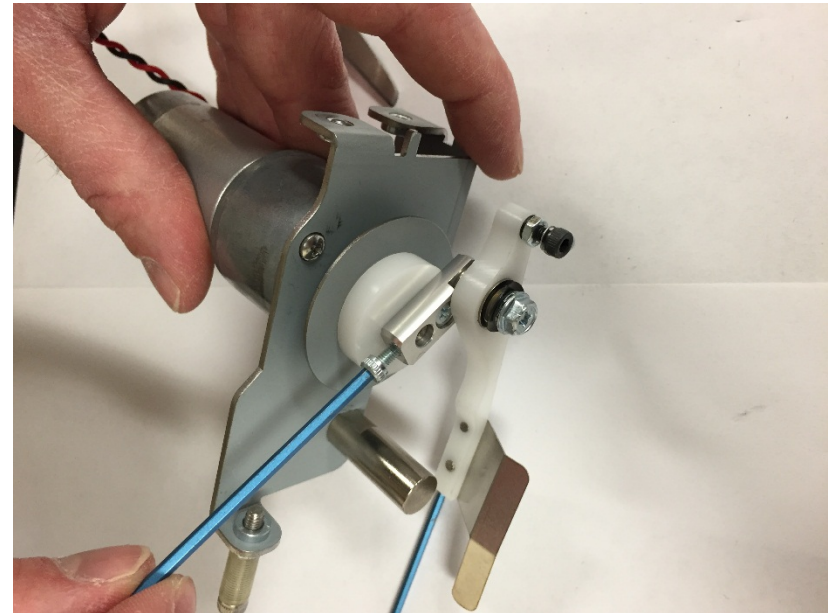

6. Remove the Tapper hub from the Motor.

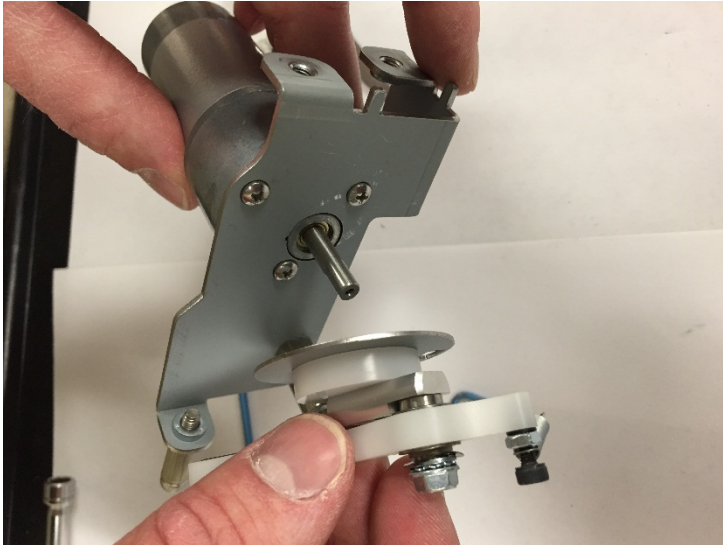

7. Remove the #4-40 Screws (3) to remove the Tapper Motor from the Tapper Frame.

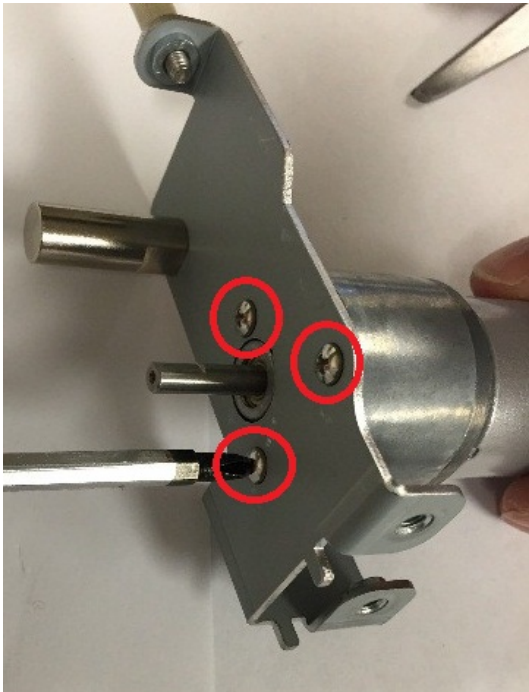

### Installation Procedure

1. Insert the new Motor into the Tapper Frame and secure it using the #4-40 Screws (3)
2. Slide the Tapper Hub onto the Motor Shaft and secure it using the set screw. Ensure that the Tapper Finger Arm rests on top of the Standoff as shown.

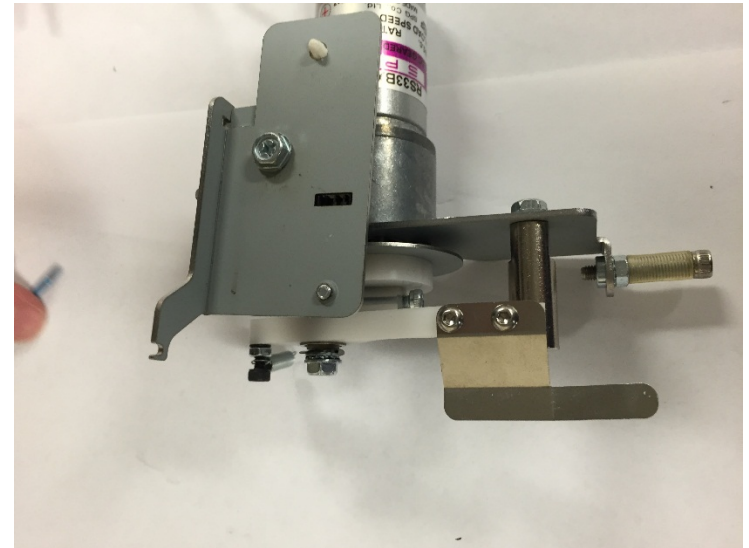

3. Ensure that the Disk Encoder is approximately centered in the Tapper Front Sensor. If it is not centered, loosen the set screw and adjust the Hub until it reaches the correct position and re-tighten the set screw.
4. Attach the Tapper Spring to the notch on the Tapper Frame.
5. Do REP 7.1 [Front Tapper Assembly Replacement](#) to Install the Front Tapper Assembly
6. Connect the Power Cord
7. Turn on the eWire.

## REP 7.3 Tapper Sensor Replacement S18 & S19

### PARTS LIST ON PL 5.17

Use this procedure to remove and install the Sensor on the Front Tapper Assembly, S18. Note: The same procedure can be used to replace the Sensor S19, on the Rear Tapper Assembly.

### Removal Procedure

#### **WARNING**

**Do not perform repair activities with the power on or electrical power supplied to the machine. Some machine components contain dangerous electrical voltages that can result in electrical shock and possible serious injury. See Section 0, page vi for other languages.**

1. Switch power OFF to eWire.
2. Disconnect the Power Cord.
3. Do REP 7.1 [Front Tapper Assembly Replacement](#) to remove the Front Tapper Assembly
4. Remove the Sensor Cable from the Front Tapper Sensor.
5. Remove the Sensor from the Tapper Frame by removing the M3 Screw.

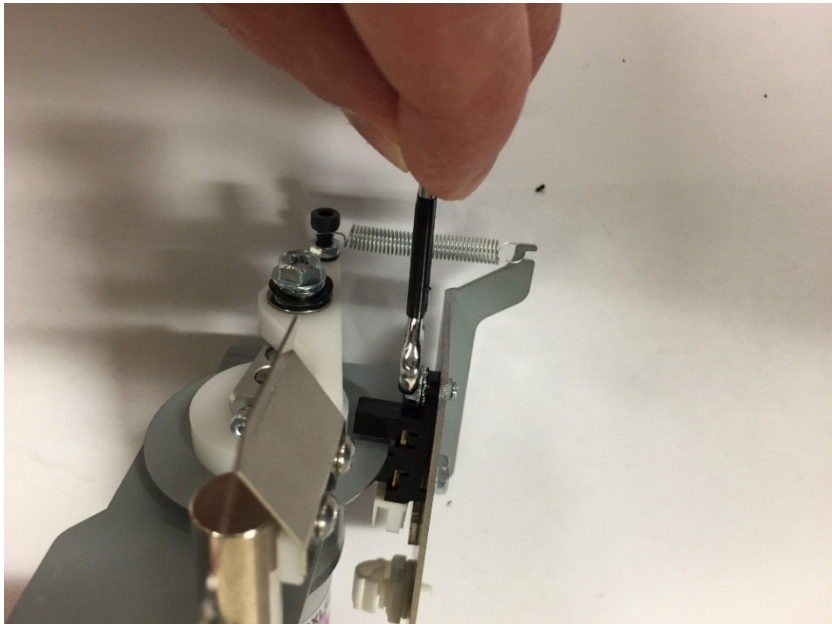

### Installation Procedure

1. Place the new Sensor onto the Tapper Frame, using the cutout for alignment.
2. Secure the sensor by tightening the M3 screw
3. Connect the Sensor Cable.
4. Do REP 7.1 [Front Tapper Assembly Replacement](#) to install the Front Tapper Assembly.
5. Connect the Power Cord
6. Turn on the eWire.

## REP 7.4 Front Tapper Spring Replacement

### PARTS LIST ON PL 5.17

Use this procedure to remove and install the Extension Spring on the Front Tapper Assembly. Note: The same procedure can be used to replace the spring on the Rear Tapper Assembly.

#### Removal Procedure

### WARNING

**Do not perform repair activities with the power on or electrical power supplied to the machine. Some machine components contain dangerous electrical voltages that can result in electrical shock and possible serious injury. See Section 0, page vi for other languages.**

1. Switch power OFF to eWire.
2. Disconnect the Power Cord.
3. Do REP 7.1 [Front Tapper Assembly Replacement](#) to remove the Front Tapper Assembly
4. Remove the Spring by removing one end from the notch on the Tapper Frame and the other end from the mounting Screw on the Tapper Finger Assembly



#### Installation Procedure

1. Reverse the steps from the Removal Procedure.

## REP 7.5 Tapper Finger Replacement

### PARTS LIST ON PL 5.17

Use this procedure to remove and install the Finger on the Front Tapper Assembly. Note: The same procedure can be used to replace the Finger on the Rear Tapper Assembly.

#### Removal Procedure

### WARNING

**Do not perform repair activities with the power on or electrical power supplied to the machine. Some machine components contain dangerous electrical voltages that can result in electrical shock and possible serious injury. See Section 0, page vi for other languages.**

1. Switch power OFF to eWire.
2. Disconnect the Power Cord.
3. Do REP 7.1 [Front Tapper Assembly Replacement](#) to remove the Front Tapper Assembly.
4. Remove (3) M3 Screws securing the Finger to the Tapper Arm and remove the Finger.

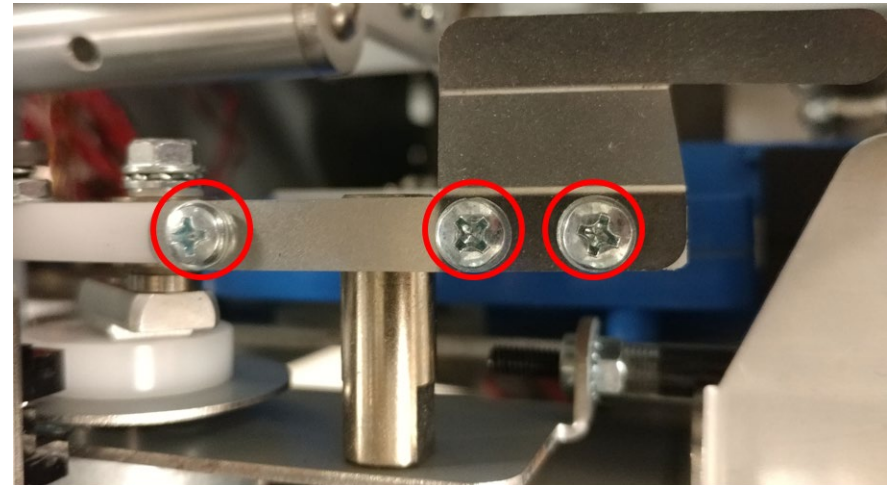

#### Installation Procedure

1. Reverse the steps from the Removal Procedure.

## REP 7.6 Rear Tapper Assembly Replacement

### PARTS LIST ON PL 5.18

Use this procedure to remove and install the Rear Tapper Assembly

#### Removal Procedure

#### **WARNING**

**Do not perform repair activities with the power on or electrical power supplied to the machine. Some machine components contain dangerous electrical voltages that can result in electrical shock and possible serious injury. See Section 0, page vi for other languages.**

1. Switch power OFF to eWire.
2. Disconnect the Power Cord.
3. Do REP 1.5 [Back Cover Replacement](#) to Remove the Back Cover.
4. Disconnect the Tapper Sensor Cable and Tapper Motor Cable from the appropriate headers.
5. Using a long screwdriver, remove the M4 Screws (2) securing the Rear Tapper to the Frame. Use the access hole in the Frame to access the screws.
6. Remove the Rear Tapper from the Frame.

#### Installation Procedure

1. Reverse the steps from the Removal Procedure.
2. Connect the Power Cord
3. Turn on the eWire.

## 8. Holder Module

### REP 8.1 Closer Staged Sensor and Closer Home Sensor S46 & S49 PARTS LIST ON PL 5.20

Use this procedure to remove and replace the Closer Staged and Closer Home Sensors

#### Removal Procedure

#### **WARNING**

**Do not perform repair activities with the power on or electrical power supplied to the machine. Some machine components contain dangerous electrical voltages that can result in electrical shock and possible serious injury. See Section 0, page vi for other languages.**

1. Turn off Power to the eWire.
2. Disconnect the Power Cord.
3. Raise the Lid and Lower Bypass.
4. If necessary, manually move the Closer forward or back to access the sensors.
5. Locate the appropriate Sensor, S46 or S49. Refer to PL 5.20, or GP 6.4.3.
6. Disconnect the Sensor Cable from the Sensor
7. Remove the Closer Staged Sensor S49 by removing the M3 Screw.

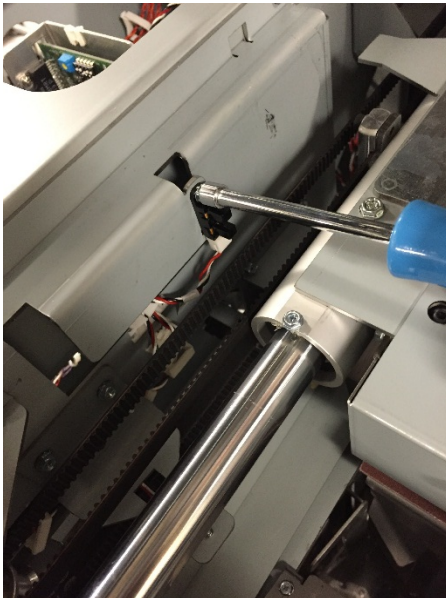

8. Remove the Closer Home Sensor S46 by removing the M3 Screw.

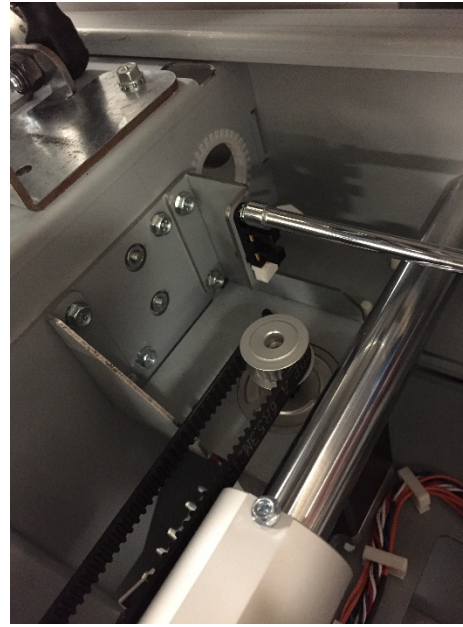

#### Installation Procedure

1. Install the new Sensor by tightening the M3 Screw. Use tab for alignment.
2. Connect the Sensor Cable.
3. Close the Lid
4. Connect the Power Cable
5. Turn power ON to the eWire.

## REP 8.2 Holder Rotate Horizontal and Vertical Sensor S34 & S35

### PARTS LIST ON PL 5.22

Use this procedure to remove and replace the Closer Rotate Sensors, horizontal and vertical.

#### Removal Procedure

### WARNING

**Do not perform repair activities with the power on or electrical power supplied to the machine. Some machine components contain dangerous electrical voltages that can result in electrical shock and possible serious injury. See Section 0, page vi for other languages.**

1. Turn off Power to the eWire.
2. Disconnect the Power Cord.
3. Raise the Lid and Lower Bypass.
4. If necessary, manually move the Closer forward to access the sensors.
5. Disconnect the Sensor Cables.
6. Remove the Sensor removing the M3 Screw.



#### Installation Procedure

1. Install the new Sensor by tightening the M3 Screw. Use tabs for alignment.
2. Connect the Sensor Cable.
3. Close the Lid
4. Connect the Power Cable
5. Turn power ON to the eWire.

### REP 8.3 Holder Position near Element Sensor S40

#### PARTS LIST ON PL 5.20

Use this procedure to remove and replace the Holder Position Near Element Sensor, S40

#### Removal Procedure

#### **WARNING**

**Do not perform repair activities with the power on or electrical power supplied to the machine. Some machine components contain dangerous electrical voltages that can result in electrical shock and possible serious injury. See Section 0, page vi for other languages.**

1. Turn off Power to the eWire.
2. Disconnect the Power Cord.
3. Raise the Lid and Lower Bypass.
4. Locate the Holder Position Near Element Sensor, at the forward edge of the Holder module, near the Deflector and Element Feeder. Refer to PL 5.20 and GP 6.4.3.
5. Disconnect the Sensor Cable.
6. Remove the Sensor by removing the M3 Screw.

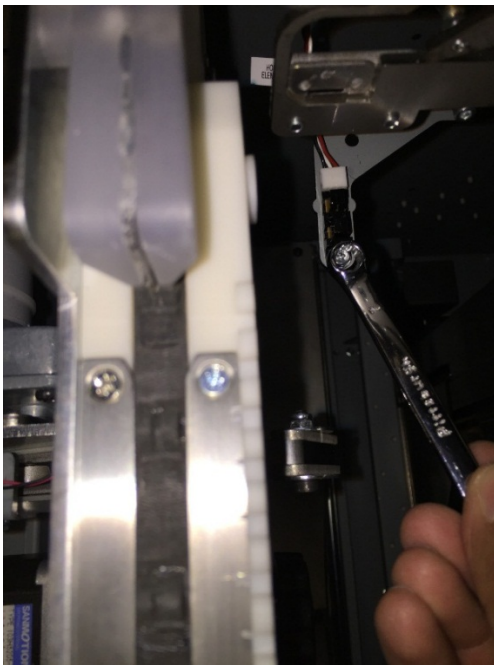

#### Installation Procedure

1. Install the new Sensor by tightening the M3 Screw. Use tab for alignment.
2. Connect the Sensor Cable.
3. Close the Lid
4. Connect the Power Cable
5. Turn power ON to the eWire.



## REP 8.4 Holder Position Closer and Holder Position Element Sensor S36 and S38

### PARTS LIST ON PL 5.20

Use this procedure to remove and replace the Holder Position Element Sensor S38, and the Holder Position Closer Sensor S36.

#### Removal Procedure

### WARNING

**Do not perform repair activities with the power on or electrical power supplied to the machine. Some machine components contain dangerous electrical voltages that can result in electrical shock and possible serious injury. See Section 0, page vi for other languages.**

1. Turn off Power to the eWire.
2. Disconnect the Power Cord.
3. Do REP 1.5 [Back Cover Replacement](#) to remove the Back Cover.
4. Locate the Holder Position Closer Sensor, located on the rear of the Holder near the Drive Pulley. Refer to PL 5.20 and GP 6.4.3.
5. Locate the Holder Position Element Sensor, located on the rear of the Holder at the other side of the cutout. Refer to PL 5.20 and GP 6.4.3.
6. Disconnect the Sensor Cable.
7. Remove the Holder Position Closer Sensor by removing the M3 Screw.

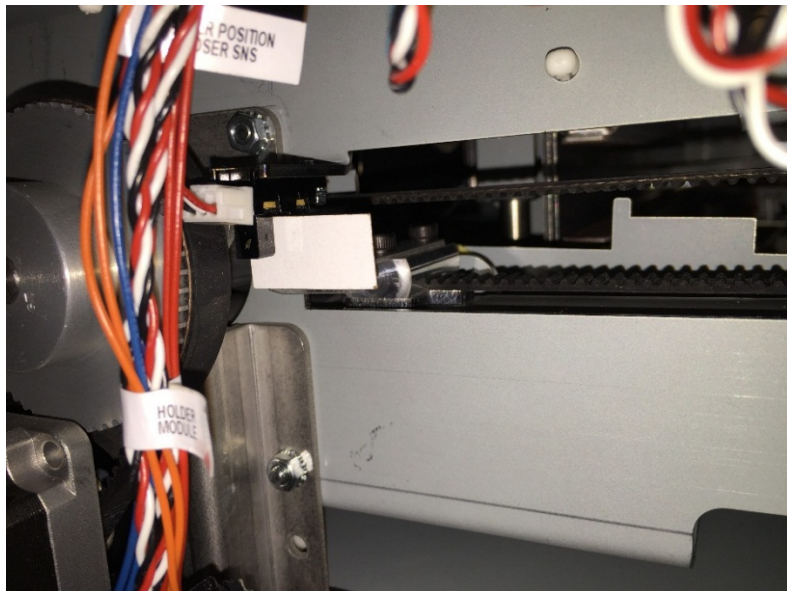

8. Remove the Holder Position Element Sensor by removing the M3 Screw.



#### Installation Procedure

1. Install the new Sensor by tightening the M3 Screw. Use tab for alignment.
2. Connect the Sensor Cable.
3. Do REP 1.5 [Back Cover Replacement](#) to install the Back Cover.
4. Connect the Power Cable
5. Turn power ON to the eWire.

## REP 8.5 Holder at Reverse Gate Sensor S39

### PARTS LIST ON PL 5.20

Use this procedure to remove and replace the Holder at Reverse Gate Sensor S39.

#### Removal Procedure

### WARNING

**Do not perform repair activities with the power on or electrical power supplied to the machine. Some machine components contain dangerous electrical voltages that can result in electrical shock and possible serious injury. See Section 0, page vi for other languages.**

1. Turn off Power to the eWire.
2. Disconnect the Power Cord.
3. Raise the Lid and Lower Bypass.
4. Locate the Holder at Reverse Gate Sensor. Refer to PL 5.20 and GP 6.4.3.
5. Disconnect the Sensor Cable.
6. Remove the Sensor by removing the M3 Screw.

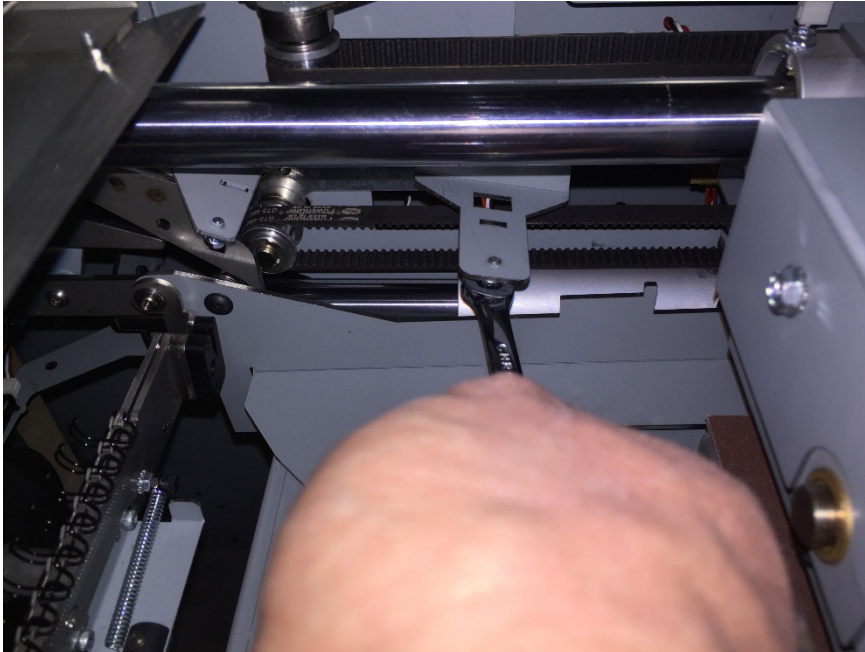

#### Installation Procedure

1. Install the new Sensor by tightening the M3 Screw. Use tab for alignment.
2. Connect the Sensor Cable.
3. Close the Lid
4. Connect the Power Cable
5. Turn power ON to the eWire.

## REP 8.6 Holder Position Stack Sensor S37

### PARTS LIST ON PL 5.20

Use this procedure to remove and replace the Holder Position Stack Sensor S37.

DO NOT CHANGE THIS SENSOR UNLESS DIRECTION TO VIA AN ESCALATION

### Removal Procedure

#### WARNING

**Do not perform repair activities with the power on or electrical power supplied to the machine. Some machine components contain dangerous electrical voltages that can result in electrical shock and possible serious injury. See Section 0, page vi for other languages.**

1. Turn off Power to the eWire.
2. Disconnect the Power Cord.
3. Raise the Lid and Lower Bypass.
4. Locate the Holder Position Stack Sensor. Refer to PL 5.20 and GP 6.4.3.
5. Disconnect the Sensor Cable.
6. Remove the Sensor by removing the M3 Screw.

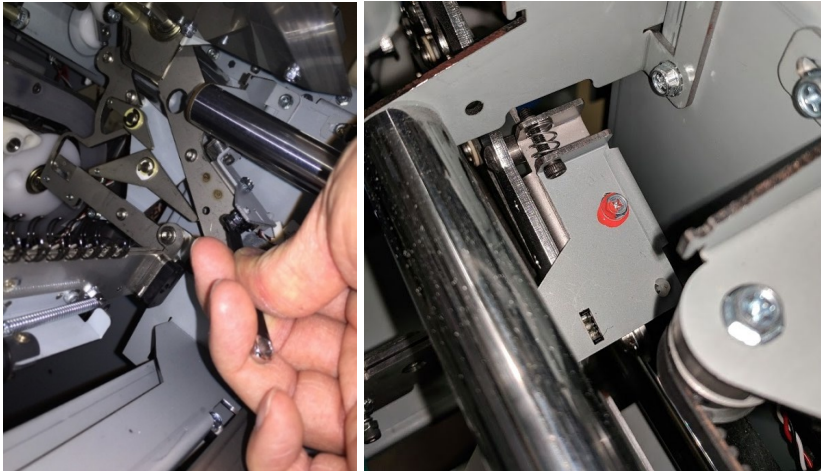

### Installation Procedure

1. Install the new Sensor by tightening the M3 Screw. Use tab for alignment.
2. Connect the Sensor Cable.
3. Close the Lid
4. Connect the Power Cable
5. Turn power ON to the eWire.
6. Perform Adj 1.10 Element Tip Height Adjustment and then Adj 1.8 Element Hook Position Adjustment.

## REP 8.7 Holder Linear Motor Replacement M15

### PARTS LIST ON PL 5.21

Use this procedure to remove and install the Holder Linear Motor, M15

#### Removal Procedure

#### WARNING

**Do not perform repair activities with the power on or electrical power supplied to the machine. Some machine components contain dangerous electrical voltages that can result in electrical shock and possible serious injury. See Section 0, page vi for other languages.**

1. Switch power OFF to eWire.
2. Disconnect the Power Cord.
3. Do REP 1.5 [Back Cover Replacement](#) to remove the Back Cover.
4. Loosen the Set screw securing the Drive Pulley to the Motor shaft.
5. Disconnect the Motor Cable from the Stepper Driver Board.

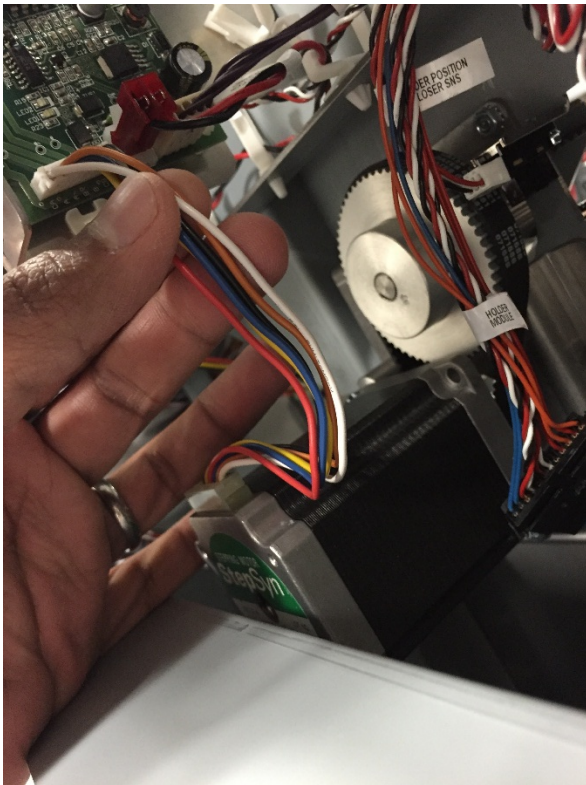

6. Remove the M4 Screws (4) to remove the Holder Linear Motor from the Standoffs.



7. Slide the Motor out of the pulley shaft and remove the motor.

#### Installation Procedure

1. Reverse the steps in the Removal Procedure.

## REP 8.8 Holder Linear Motor Replacement M21

### PARTS LIST ON PL 5.21

Use this procedure to remove and install the Closer Linear Motor, M21

#### Removal Procedure

#### WARNING

**Do not perform repair activities with the power on or electrical power supplied to the machine. Some machine components contain dangerous electrical voltages that can result in electrical shock and possible serious injury. See Section 0, page vi for other languages.**

1. Switch power OFF to eWire.
2. Disconnect the Power Cord.
3. Do REP 1.5 [Back Cover Replacement](#) to remove the Back Cover.
4. Do REP 1.6 [Side Cover Replacement](#) to remove the downstream Side Cover.
5. Loosen the Set screw securing the Drive Pulley to the Motor shaft.
6. Disconnect the Sensor Cable from the Closer Home Sensor S46 (refer to REP 8.1 [Closer Staged Sensor and Closer Home Sensor S46 & S49](#)).
7. Disconnect the Motor Cable from the Stepper Driver Board.

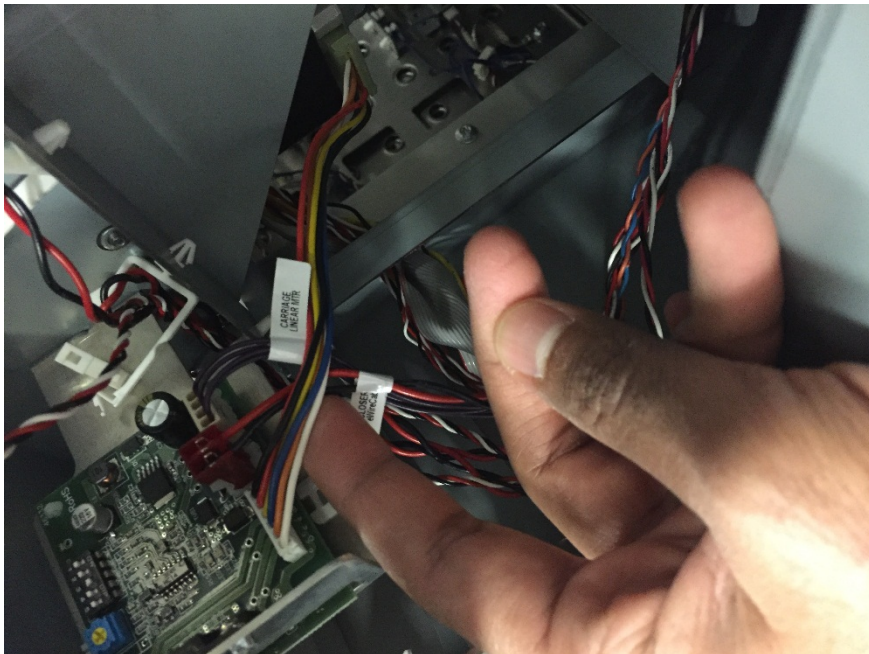

8. Remove the M4 Screws (4) to remove the Motor Mounting Bracket from the Holder

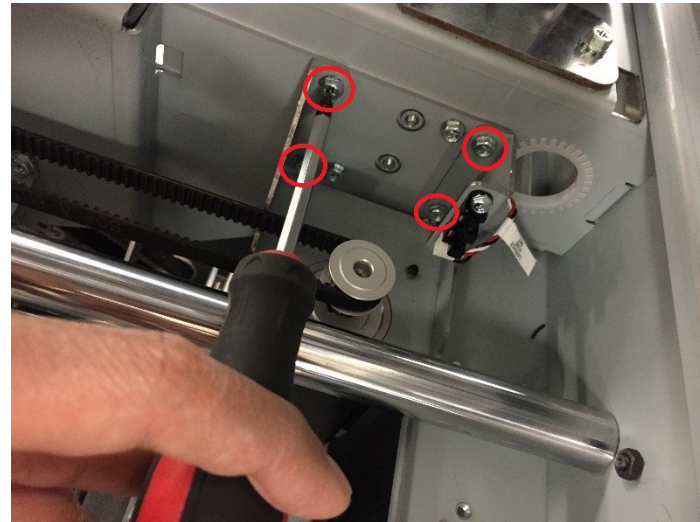

9. Remove the Pulley and remove the Motor Bracket Assembly from the Holder.
10. Remove the M4 Screws (4) to remove the Motor from the Mounting Bracket.

#### Installation Procedure

1. Attach the new Motor to the Mounting Bracket using the M4 Screws (4).
2. Position the Mounting Bracket Assembly within the Holder and secure it using the M4 Screws (4).
3. Attach the Pulley and Belt to the Motor shaft and tighten the set screw.
4. Attach the Sensor Cable to the S46 Sensor and secure the cables using the cable clamps on the Motor Bracket.
5. Connect the Motor Cable to the appropriate Stepper Driver.
6. Replace the Back and Side cover.
7. Connect the Power Cord and resume operation.

## REP 8.9 Holder Rotate Motor Replacement M14

### PARTS LIST ON PL 5.21

Use this procedure to remove and install the Holder Rotate Motor, M14

#### Removal Procedure

#### WARNING

**Do not perform repair activities with the power on or electrical power supplied to the machine. Some machine components contain dangerous electrical voltages that can result in electrical shock and possible serious injury. See Section 0, page vi for other languages.**

1. Switch power OFF to eWire.
2. Disconnect the Power Cord.
3. Raise the Lid and Lower Transport Assembly.
4. Locate the Holder Rotate Motor on the Holder Frame.
5. Disconnect the Motor Cables at the header.

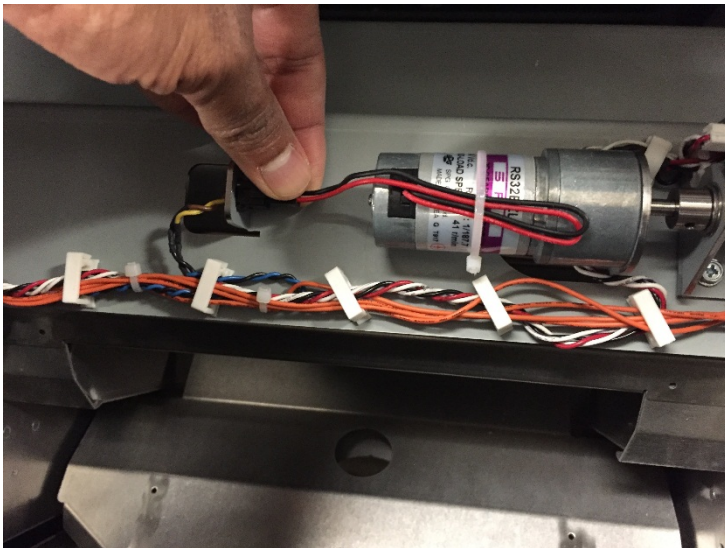

6. Loosen the Set Screw securing the Pulley to the Motor Shaft.

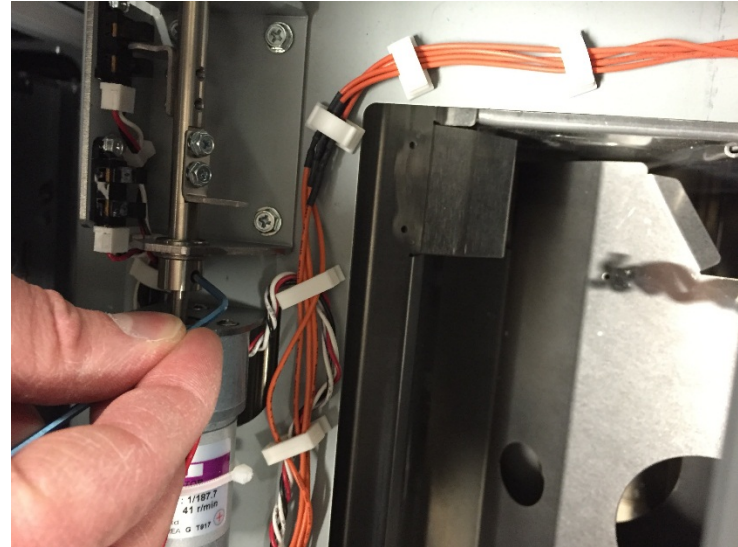

7. Loosen the Screw securing the Crank Block to the Shaft, and remove the Screw and Spacer.
8. Disconnect the Sensor Cables at the Holder Rotate Horizontal and Holder Rotate Vertical Sensors. Refer to REP 8.2 [Closer Rotate Horizontal and Vertical Sensor S34 & S35](#)

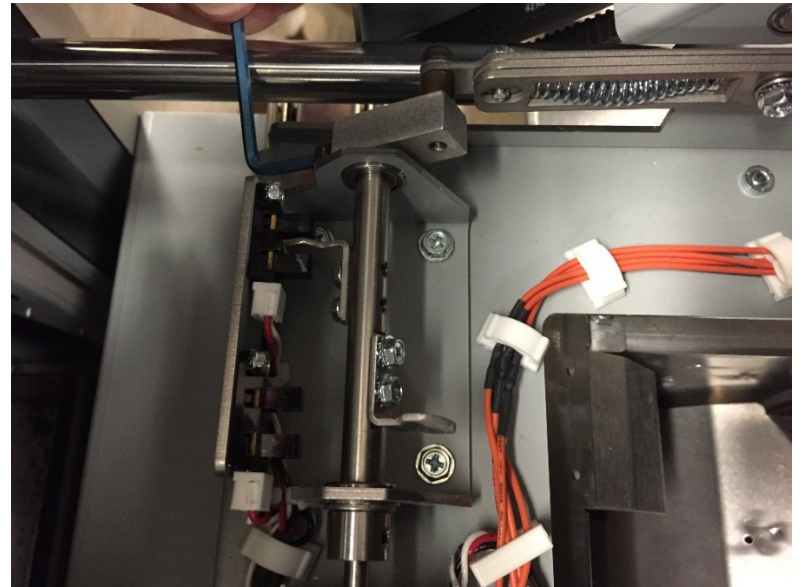

9. Loosen the M4 Screws (3) and remove the Holder Rotate Assembly from the Holder.

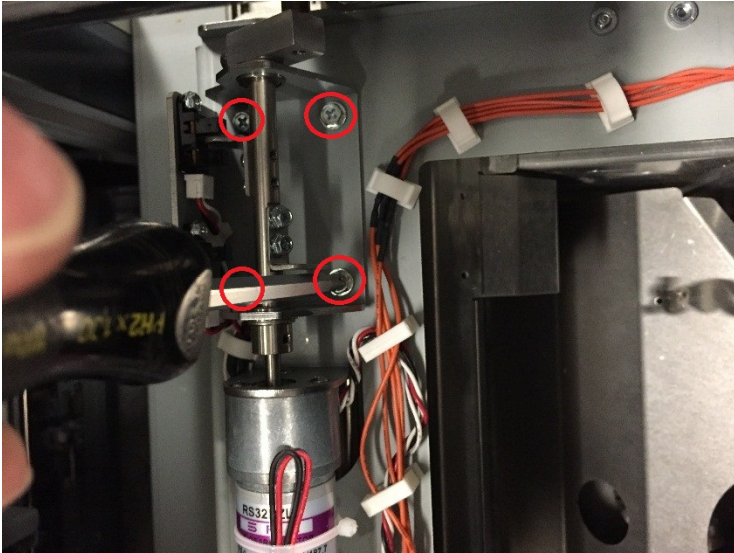

10. Remove the #4-40 Screws (3) securing the Motor and remove the Motor from the Holder Rotate Base.



### Installation Procedure

1. Attach the new Motor to the Holder Rotate Assembly using the #4-40 Screws (4).
2. Tighten the set screw to secure the Rotate Shaft to the Motor Shaft.
3. Position the Holder Rotate Assembly within the Holder.
4. Attach the Crank Block to the Holder Rotate Shaft using the M4 Screw and Spacer.
5. Secure the Holder Rotate Assembly to the Holder frame using the M4 Screws (4).
6. Attach the Sensor Cables.
7. Connect the Motor Cable.
8. Connect the Power Cord and resume operation.

## REP 8.10 Closer Linear Drive Belt Replacement

### PARTS LIST ON PL 5.21

Use this procedure to remove and install the Closer Linear Drive Belt.

#### Removal Procedure

#### WARNING

**Do not perform repair activities with the power on or electrical power supplied to the machine. Some machine components contain dangerous electrical voltages that can result in electrical shock and possible serious injury. See Section 0, page vi for other languages.**

1. Switch power OFF to eWire.
2. Disconnect the Power Cord.
3. Open the Lid and Lower Bypass.
4. Loosen the M4 Screws (2) securing the Timing Belt Bracket and adjust the Bracket to relieve tension on the Belt.



5. Remove the M4 Screws securing the Timing Belt Clamp, and remove the Timing Belt Clamp.

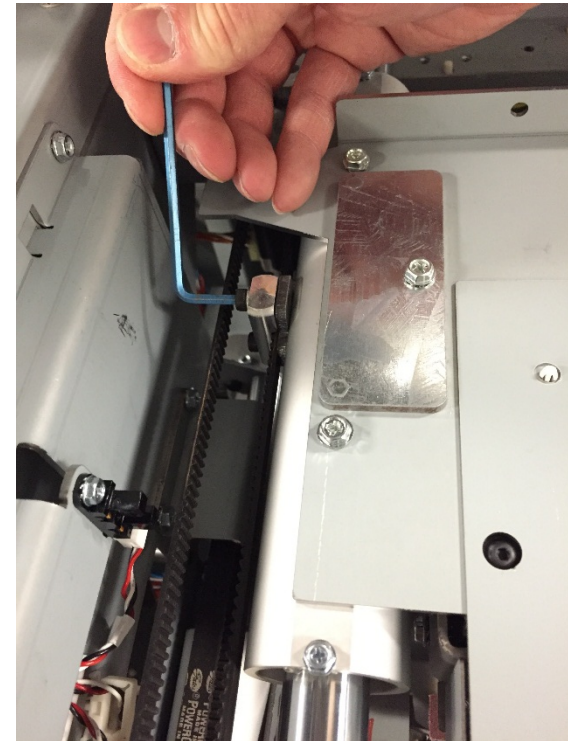

6. Slide the Timing Belt off the Pulleys and remove the Timing Belt.

#### Installation Procedure

1. Place the new Timing Belt in position and align it to the Pulleys.
2. Secure the Timing Belt Clamp using the M4 Screws to secure the Belt to the Closer.
3. Adjust the Timing Belt Bracket to appropriate belt tension and secure the Timing Belt Bracket by tightening the Screws.
4. Connect the Power Cord
5. Turn power ON to eWire.



## REP 8.11 Holder Linear Drive Belt – Front Replacement

### PARTS LIST ON PL 5.21

Use this procedure to remove and install the Holder Linear Drive Belt, Front. Note that the same belt is also used on the rear side of the Holder.

#### Removal Procedure

#### **WARNING**

**Do not perform repair activities with the power on or electrical power supplied to the machine. Some machine components contain dangerous electrical voltages that can result in electrical shock and possible serious injury. See Section 0, page vi for other languages.**

1. Switch power OFF to eWire.
2. Disconnect the Power Cord.
3. Open the Lid and Lower Bypass.
4. Loosen the M4 Screws securing the Timing Belt Bracket and adjust the Bracket to relieve tension on the Belt.

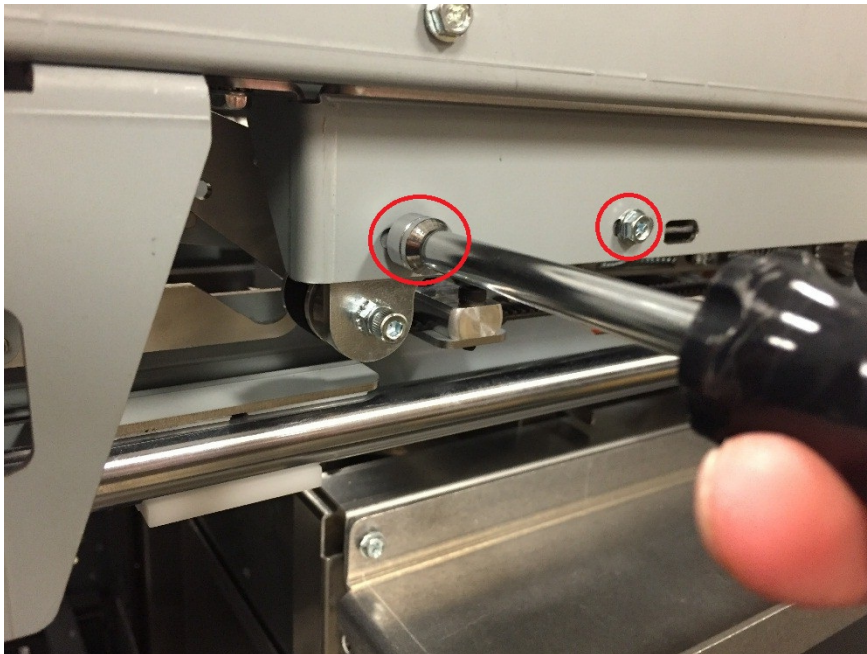

5. Remove the M4 Screws securing the Timing Belt Clamp, and remove the Timing Belt Clamp.

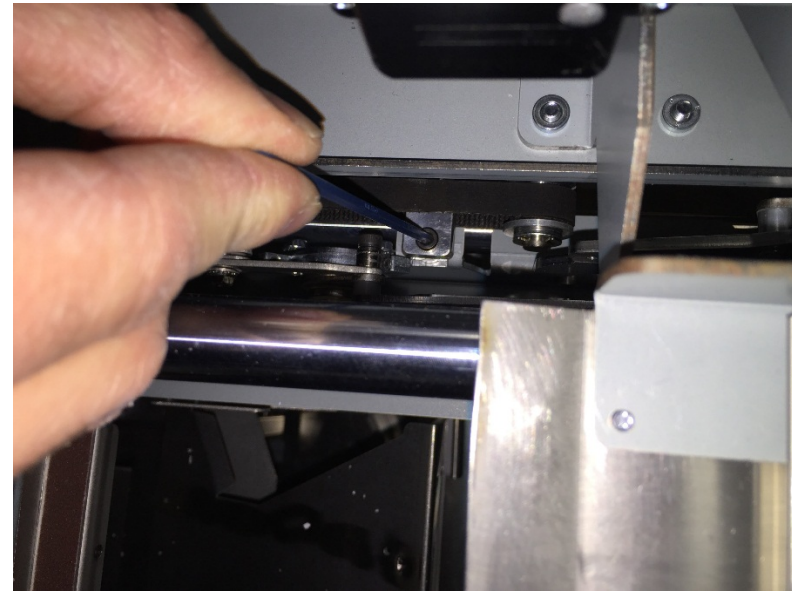

6. Slide the Timing Belt off the Pulleys and remove the Timing Belt.

#### Installation Procedure

1. Place the new Timing Belt in position and align it to the Pulleys.
2. Secure the Timing Belt Clamp using the M4 Screws to secure the Belt to the Closer.
3. Adjust the Timing Belt Bracket to appropriate level of belt tension and secure the Timing Belt Bracket by tightening the Screws.
4. Connect the Power Cord
5. Turn power ON to eWire.

## REP 8.12 Holder Linear Drive Belt – Rear Replacement

### PARTS LIST ON PL 5.21

Use this procedure to remove and install the Holder Linear Drive Belt, Rear. Note that the same belt is also used on the front side of the Holder.

### Removal Procedure

#### **WARNING**

**Do not perform repair activities with the power on or electrical power supplied to the machine. Some machine components contain dangerous electrical voltages that can result in electrical shock and possible serious injury. See Section 0, page vi for other languages.**

1. Switch power OFF to eWire.
2. Disconnect the Power Cord.
3. Do REP 1.1 [Back Cover Replacement](#) to remove the Back Cover.
4. Loosen the M4 Screws securing the Timing Belt Bracket and adjust the bracket to relieve tension on the belt.
5. Remove the M4 Screws securing the Timing Belt Clamp, and remove the Timing Belt Clamp.

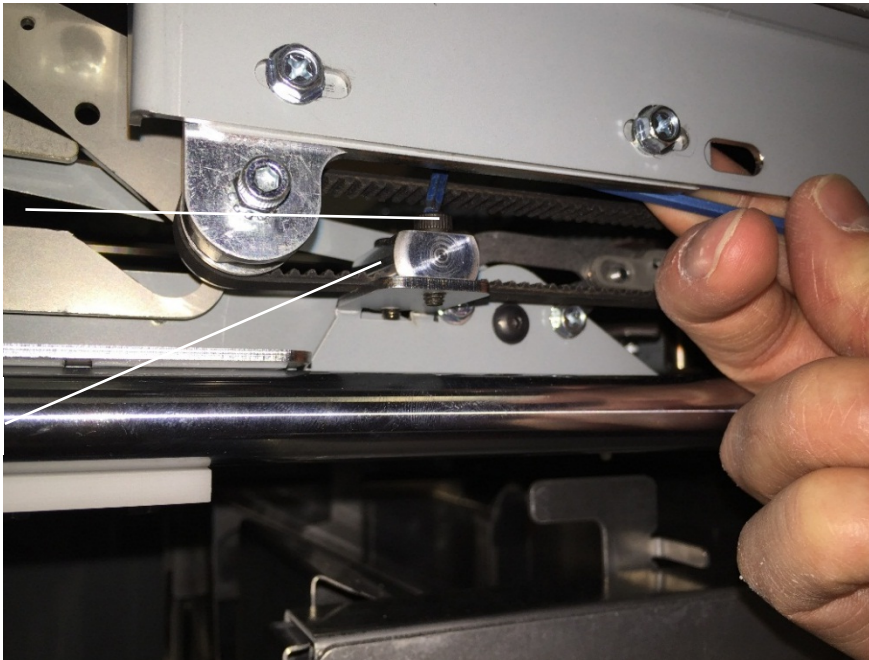

6. Slide the Timing Belt off the Pulleys and remove the Timing Belt.

### Installation Procedure

1. Position the new Timing Belt around the Pulleys and align it to the Pulleys.
2. Secure the Timing Belt Clamp using the M4 Screws to secure the Belt to the Closer.
3. Adjust the Timing Belt Bracket to appropriate level of belt tension and secure the Timing Belt Bracket by tightening the Screws.
4. Connect the Power Cord
5. Turn power ON to eWire.

## REP 8.13 Holder Gates Spring Lower Replacement

### PARTS LIST ON PL 5.21

Use this procedure to remove and install the Holder Gates Spring, Lower. Note that this procedure applies to the extension springs on the front and rear sides of the Holder.

#### Removal Procedure

### WARNING

**Do not perform repair activities with the power on or electrical power supplied to the machine. Some machine components contain dangerous electrical voltages that can result in electrical shock and possible serious injury. See Section 0, page vi for other languages.**

1. Switch power OFF to eWire.
2. Disconnect the Power Cord.
3. Open the Lid and Lower Bypass.
4. Remove the M3 Screw and Nut to release the end of the extension spring.



5. Repeat the procedure to remove the M3 Screw and Nut at the opposite end of the extension spring. Remove the old spring.
6. If necessary, use the same process to remove the Holder Gates Lower Spring on the opposite side of the Holder.

#### Installation Procedure

1. Thread the M3 Screw and Nut through the end of the extension spring and attach the Screw to the Holder. Secure it using the M3 Nut.
2. Repeat the Procedure to secure the opposite end of the spring.
3. If necessary, use the same process to replace the Holder Gates Spring Lower on the opposite side of the Holder.
4. Connect the Power Cord
5. Turn power ON to eWire.

## REP 8.14 Holder Gates Spring Upper Replacement

### PARTS LIST ON PL 5.21

Use this procedure to remove and install the Holder Gates Spring Upper. Note that this procedure applies to the extension springs on the front and rear sides of the Holder.

### Removal Procedure

#### **WARNING**

**Do not perform repair activities with the power on or electrical power supplied to the machine. Some machine components contain dangerous electrical voltages that can result in electrical shock and possible serious injury. See Section 0, page vi for other languages.**

1. Switch power OFF to eWire.
2. Disconnect the Power Cord.
3. Open the Lid and Lower Bypass.
4. Remove the M3 Screw and Nut to release the end of the extension spring.



5. Repeat the procedure to remove the M3 Screw and Nut at the opposite end of the extension spring. Remove the old spring.
6. If necessary, use the same process to remove the Holder Gates Upper Spring on the opposite side of the Holder.

### Installation Procedure

1. Thread the M3 Screw and Nut through the end of the extension spring and attach the Screw to the Holder. Secure using the M3 Nut.
2. Repeat the Procedure to secure the opposite end of the spring.
3. If necessary, repeat the procedure for the Holder Gates Upper Spring on the opposite side of the Holder.
4. Connect the Power Cord
5. Turn power ON to eWire.

## REP 8.15 Linear Spring Plate Assembly

### PARTS LIST ON PL 5.21

Use this procedure to remove and install the Linear Spring Plate Assembly

#### Removal Procedure

### WARNING

**Do not perform repair activities with the power on or electrical power supplied to the machine. Some machine components contain dangerous electrical voltages that can result in electrical shock and possible serious injury. See Section 0, page vi for other languages.**

1. Switch power OFF to eWire.
2. Disconnect the Power Cord.
3. Open the Lid and Lower Bypass.
4. Open the Book Tray Door and locate the Linear Spring Plate Assembly on the bottom side of the Holder.
5. Remove the M4 Screws (2) and remove the Linear Spring Plate

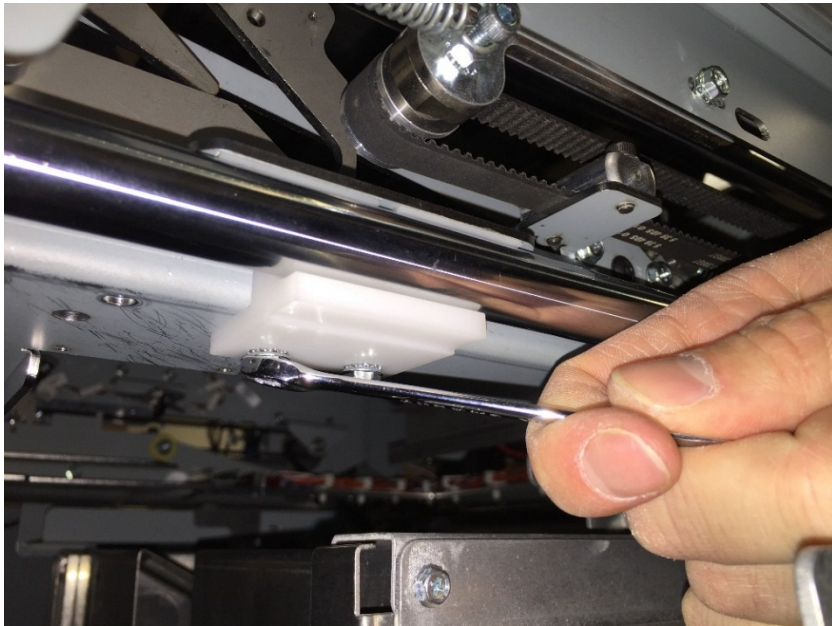

6. If necessary, repeat this procedure for the second Linear Spring Plate Assembly.

#### Installation Procedure

1. Reverse the steps in the Removal Procedure.
2. Connect the Power Cord
3. Turn power ON to eWire.

## REP 8.16 Holder Removal and Replacement

Use this procedure to replace the Holder assembly.

### Removal Procedure

#### WARNING

Do not perform repair activities with the power on or electrical power supplied to the machine. Some machine components contain dangerous electrical voltages that can result in electrical shock and possible serious injury. See Section 0, page vi for other languages.

1. Switch power OFF to eWire.
2. Disconnect the Power Cord.
3. Open the Lid and Lower Bypass.
4. Remove the ribbon cable from the holder header.



5. Remove the M4 Hex Nut, Screw and Spacer securing the Holder Link to the Front Element Holder Hinge. Hold the top of the screw head with an Allen wrench or a finger when loosening the nut to prevent the screw and spacer from falling into the machine.



6. Remove the M4 fasteners securing the holder rotate hinges.

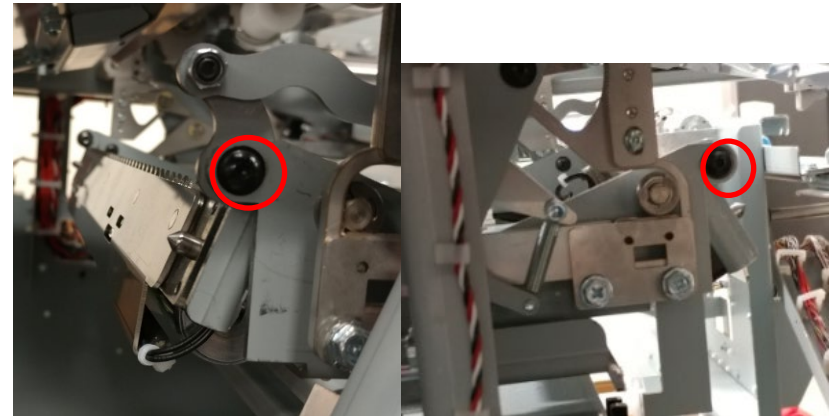

7. Remove the holder by pulling the holder toward the front of the machine and rotate the holder to disengage the pivot hinge.

## Installation Procedure

1. Reverse the Steps found in the Removal Procedure
2. When mounting the ribbon cable, ensure that it is set as low as it can be placed in the clamp.

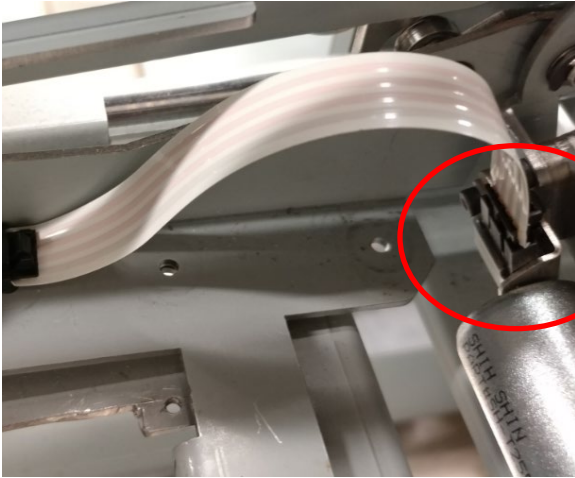

3. Connect the Power Cord
4. Turn power ON to eWire.

## Testing Procedure

Check the following Adjustments to ensure the holder is positioned correctly.

1. ADJ 1.1 Element Position Skew Adjustment
2. ADJ 1.3 Holder Mating to Element Feeder
3. ADJ 1.9 Holder Rotate Adjustment
4. ADJ 1.10 Element Tip Height Adjustment
5. ADJ 1.14 Element Xfer Position Adjustment
6. ADJ 1.8 Element Hook Position Adjustment

## REP 8.17 Holder Lock Sub-Assembly Replacement

### PARTS LIST ON PL 5.22

Use this procedure to remove and install the Holder Lock Sub-Assembly

### Removal Procedure

#### WARNING

**Do not perform repair activities with the power on or electrical power supplied to the machine. Some machine components contain dangerous electrical voltages that can result in electrical shock and possible serious injury. See Section 0, page vi for other languages.**

1. Switch power OFF to eWire.
2. Disconnect the Power Cord.
3. Open the Lid and Lower Bypass.
4. Locate the Holder Lock Sub-Assembly.
5. Disconnect the Solenoid Cables at the header.



6. Remove the M4 Screw securing the Rear Hinge of the Holder Lock Sub-Assembly to the Holder Frame. While supporting the Holder Lock Sub-Assembly, remove the screw, washers, flange and stud.
7. Remove the M3 Screw securing the Upper Link of the Holder to the Holder Lock Sub-Assembly Front Hinge.
8. Remove the M4 Screw securing the Holder Frame to the Front Hinge of the Holder Lock Sub-Assembly. While supporting the Holder Lock Sub-Assembly, remove the screw, washers, flange and stud.
9. Remove the Holder Lock Sub-Assembly from the Holder.

### Installation Procedure

1. Reverse the Steps found in the Removal Procedure
2. Connect the Power Cord
3. Turn power ON to eWire.

## REP 8.18 Holder Link Replacement

### PARTS LIST ON PL 5.21

Use this procedure to replace the Holder Link.

#### Removal Procedure

#### WARNING

**Do not perform repair activities with the power on or electrical power supplied to the machine. Some machine components contain dangerous electrical voltages that can result in electrical shock and possible serious injury. See Section 0, page vi for other languages.**

1. Switch power OFF to eWire.
2. Disconnect the Power Cord.
3. Open the Lid and Lower Bypass.
4. Remove the M3 Nylock Hex Nut and washer securing the Holder Link to the Holder Rotate Mandrel to release one end of the link.



5. Remove the M4 Hex Nut, Screw and Spacer securing the Holder Link to the Front Element Holder Hinge. Hold the top of the screw head with an Allen wrench or a finger when loosening the nut to prevent the screw and spacer from falling into the machine.

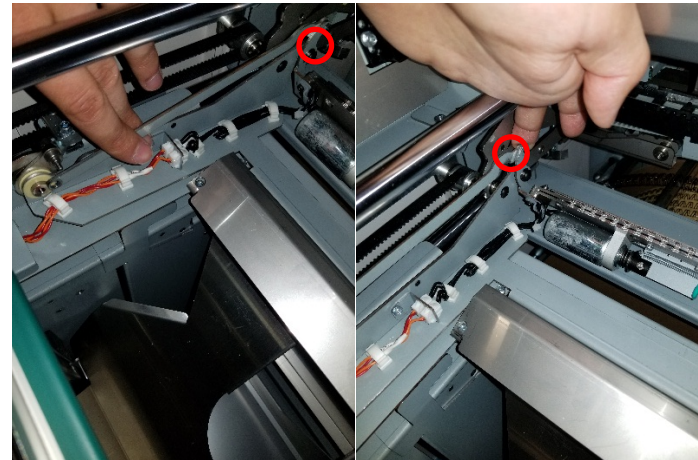

6. Remove the old Holder link from the machine and install the M4 Screw and Spacer into the new Holder link as shown.

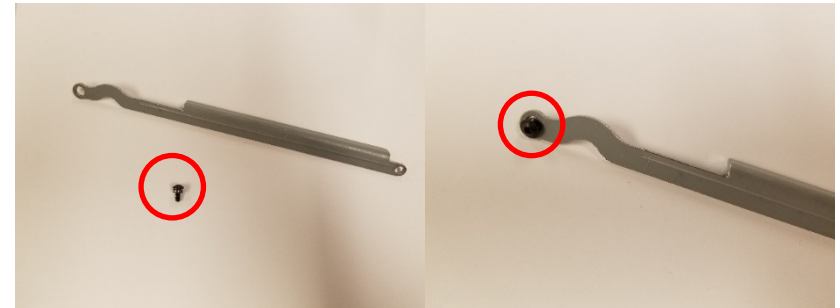

#### Installation Procedure

1. Reverse the Steps found in the Removal Procedure
2. Connect the Power Cord
3. Turn power ON to eWire.



## REP 8.19 Holder Lock Solenoid Replacement

### PARTS LIST ON PL 5.22

Use this procedure to remove and install the Holder Lock Solenoid L8. Note that this procedure applies to both solenoids on the Holder.

#### Removal Procedure

#### WARNING

Do not perform repair activities with the power on or electrical power supplied to the machine. Some machine components contain dangerous electrical voltages that can result in electrical shock and possible serious injury. See Section 0, page vi for other languages.

1. Follow REP 8.16 to remove the Holder Assembly.
2. Remove the header clamp



3. Remove the wireway cover.



4. Loosen the two M3 fasteners securing the solenoids to the holder and remove the Solenoid Coils



5. Remove the solenoid coil wire from behind the mounting tab.



6. Remove the E-Clips securing the Solenoid core using a flat head screw driver.

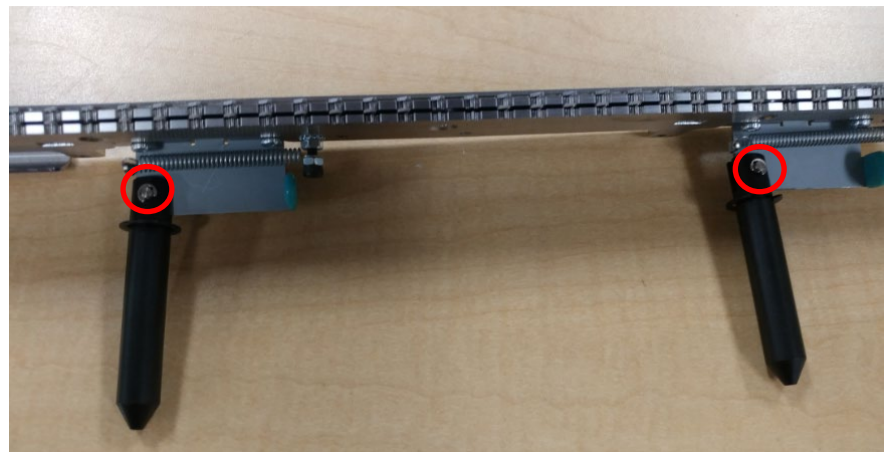

### Installation Procedure

1. Thread the Link Pin through the Solenoid Core and the Holder Lock Sub-Assembly bracket. Secure the Link Pin by attaching the E-Ring.
2. Insert the new Solenoid into the Solenoid Clamp and position it to the Holder Lock Assembly. Secure the Solenoid Clamp using the M3 Screw. Make sure not to pinch the solenoid wires between the plates when tightening the M3 Screws.
3. Install the Wireway Cover using the 2 M3 Fasteners
4. Clamp the Solenoid Cable Harness.
5. Ensure the solenoid wires are tucked away and secured as shown in the photo below.



6. Follow the REP 8.16 for the installation of the Holder Assembly

## 9. Frame

### REP 9.1 Interlock Switch Replacement, Top Cover

#### PARTS LIST ON PL 5.25

Use this procedure to remove and install the Interlock Switch for the Top Cover.

#### Removal Procedure

#### WARNING

**Do not perform repair activities with the power on or electrical power supplied to the machine. Some machine components contain dangerous electrical voltages that can result in electrical shock and possible serious injury. See Section 0, page vi for other languages.**

1. Switch power OFF to eWire.
2. Disconnect the Power Cord.
3. Raise the Top Cover.
4. Remove the M4 Screws (2) to remove the Interlock Bracket.
5. Disconnect the Cables to the Interlock Switch. Note the orientation of the Cables as they need to be re-installed in the same configuration.

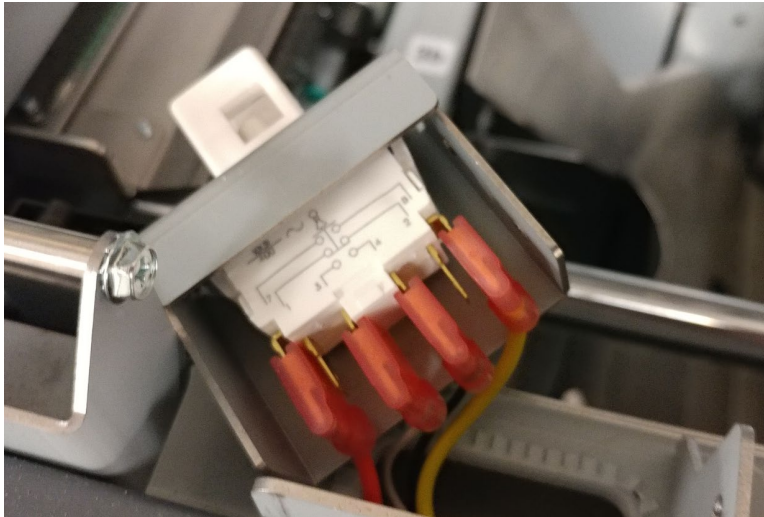

6. Remove the old interlock by depressing the tabs on the interlock and removing it from the cutout in the bracket.

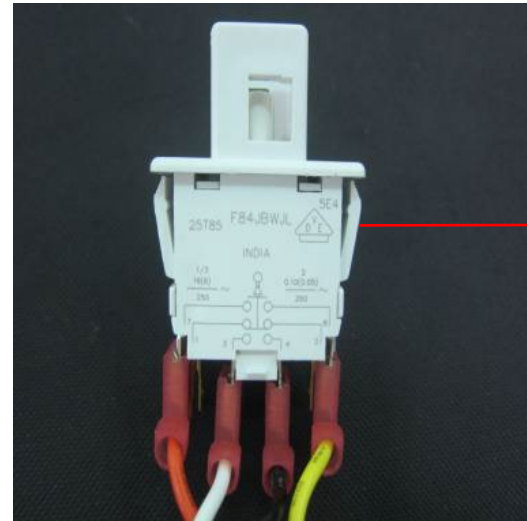

Tabs

#### Installation Procedure

1. Install the new Interlock by pressing it into the Interlock Bracket until the tabs snap into place.
2. Reattach the wires, being careful to maintain the correct wire orientation.
3. Position the interlock switch on the Frame and secure it using the M4 Screws and Washers (2).
4. If necessary, adjust the Interlock Switch position so that the Interlock Flag is centered in the Interlock Switch.
5. Connect the Power Cord
6. Turn power ON to eWire.

## REP 9.2 Interlock Switch Replacement, Doors

### PARTS LIST ON PL 5.25

Use this procedure to remove and install the Element Feeder Door and Book Tray Door Interlock Switches.

### WARNING

**Do not perform repair activities with the power on or electrical power supplied to the machine. Some machine components contain dangerous electrical voltages that can result in electrical shock and possible serious injury. See Section 0, page vi for other languages.**

### Removal Procedure

1. Switch power OFF to eWire.
2. Disconnect the Power Cord.
3. Open the Element Feeder and Book Tray Doors.
4. Remove the M4 Screws (3) and remove the Interlock Switch Bracket. Remove the Bracket carefully to avoid damaging the wires.



5. Remove the wires from the appropriate Interlock Switch. Note the orientation of the wires before disconnecting.

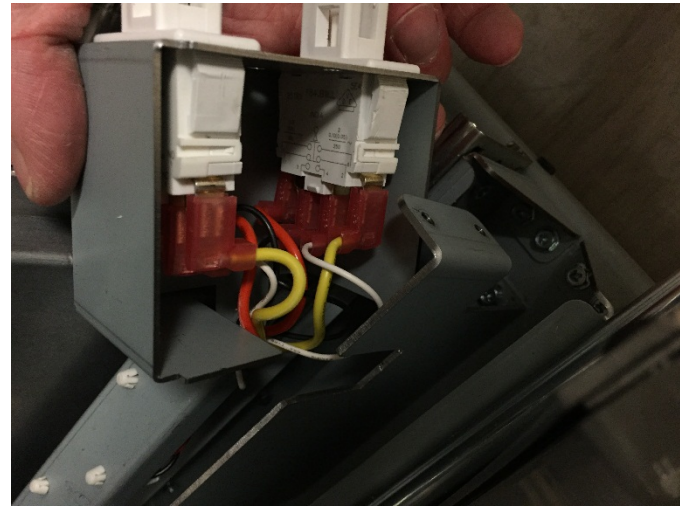

6. Remove the old interlock by depressing the tabs on the interlock and removing it from the cutout in the bracket.

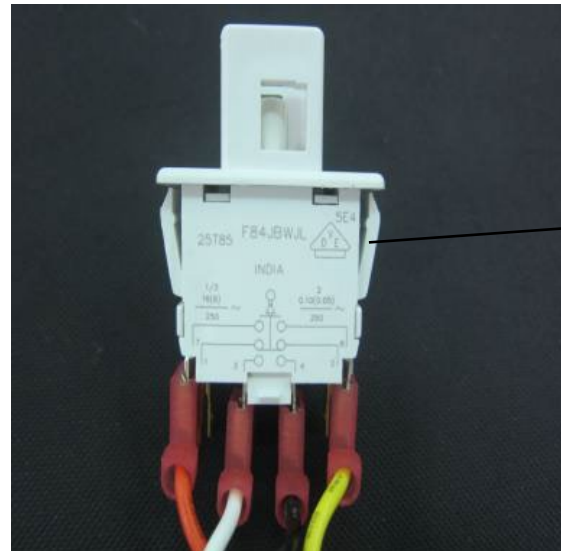

Tabs

## Installation Procedure

1. Install the new Interlock by pressing it into the Interlock Bracket until the tabs snap into place.
2. Reattach the wires, being careful to maintain the correct wire orientation.
3. Position the Interlock Bracket on the Frame and secure it using the M4 Screws (3).
4. Do ADJ 1.7 to adjust the Interlock Flag position on the Element Feeder Door and/or Book Tray Door.
5. Connect the Power Cord
6. Turn power ON to eWire.

## REP 9.3 Lower Transport Assembly Latch Replacement

### PARTS LIST ON PL 5.27

Use this procedure to remove and install the Upper Bypass Latch. Refer to REP [2.27](#) Lower Transport Latch Replacement to replace the male portion of the latch.

### WARNING

**Do not perform repair activities with the power on or electrical power supplied to the machine. Some machine components contain dangerous electrical voltages that can result in electrical shock and possible serious injury. See Section 0, page vi for other languages.**

1. Switch power OFF to eWire.
2. Disconnect the Power Cord.
3. Remove the M3 Screws (4) from the Latch Housing, and remove the old latch.

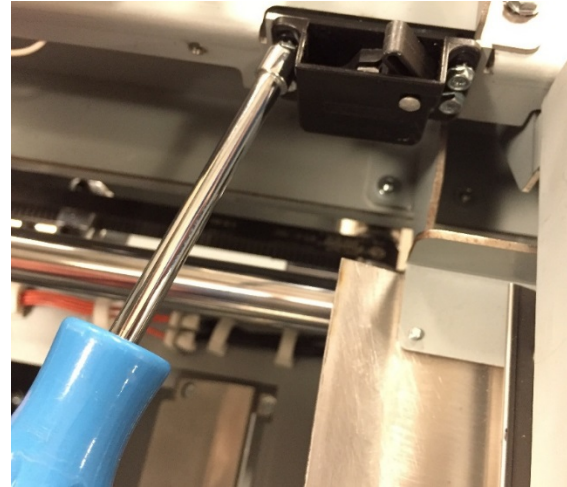

### Installation Procedure

1. Install the new Latch Housing by attaching the M3 Screws (4).
2. Ensure that the Lower Bypass closes easily. If necessary, adjust the position of the Latch on the Lower Bypass.
3. Connect the Power Cord.
4. Power ON the eWire.

## REP 9.4 Book Tray Latch Replacement

### PARTS LIST ON PL 5.27

Use this procedure to remove and install the Latch for the Book Tray Drawer. Note that the latch is in two parts, on the drawer and frame.

#### Removal Procedure

#### **WARNING**

**Do not perform repair activities with the power on or electrical power supplied to the machine. Some machine components contain dangerous electrical voltages that can result in electrical shock and possible serious injury. See Section 0, page vi for other languages.**

1. Turn off Power to the eWire.
2. Disconnect the Power Cord.
3. Locate the male half of the Latch on the back of the drawer. Remove the Latch by removing the M4 Screws (2) and Washers.



4. Locate the female half of the Latch on the bottom of the Frame. Remove the Latch by removing the M3 Screws (4).



#### Installation Procedure

1. Install the new Latch to the frame and secure it using the M3 Screws (4). Install the new Latch to the Book Drawer and secure it using the M4 Screws (2) and Washers.
2. Adjust the latch position so that the latch fits together easily. Tighten the screws when latch is properly located.
3. Connect the Power Cord.
4. Turn on power to the eWire.

## REP 9.5 Element Feeder Drawer Latch Replacement

### PARTS LIST ON PL 5.27

Use this procedure to remove and install the Latch for the Element Feeder Drawer. Note that the latch is in two parts, on the drawer and frame.

#### Removal Procedure

#### WARNING

**Do not perform repair activities with the power on or electrical power supplied to the machine. Some machine components contain dangerous electrical voltages that can result in electrical shock and possible serious injury. See Section 0, page vi for other languages.**

1. Turn off Power to the eWire.
2. Disconnect the Power Cord.
3. Locate the male half of the Latch on the back of the drawer. Remove the Latch by removing the M4 Screws (2) and Washers.



4. Locate the female half of the Latch on the bracket near the back of the Frame. Remove the Latch by removing the M3 Screws (4).

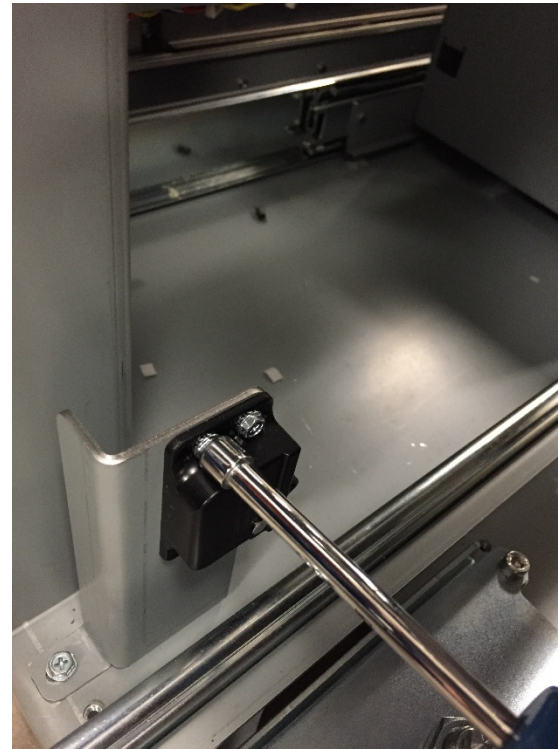

#### Installation Procedure

1. Install the new Latch to the frame and secure it using the M3 Screws (4). Install the new Latch to the Element Feeder Drawer and secure it using the M4 Screws (2).
2. Adjust the latch position so that the latch fits together easily. Tighten the screws when latch is properly located.
3. Connect the Power Cord.
4. Turn on power to the eWire.

## REP 9.6 Stepper Driver Boards Replacement, M3, M5, M15 & M21

Use this procedure to remove and install the Stepper Driver Boards for motors M3, M5, M15 and M21.

### Removal Procedure

#### WARNING

**Do not perform repair activities with the power on or electrical power supplied to the machine. Some machine components contain dangerous electrical voltages that can result in electrical shock and possible serious injury. See Section 0, page vi for other languages.**

1. Press the Power switch to OFF position.
2. Disconnect the Power Cord.
3. For M3, M15 and M21, do REP 1.5 [Back Cover Replacement](#) to remove the Back Cover. For M5, do REP 1.6 [Side Cover Replacement](#) to remove the Side Cover.
4. Note the wire connection locations on the back of the Switch.
5. Disconnect the Cables from the appropriate Stepper Driver.

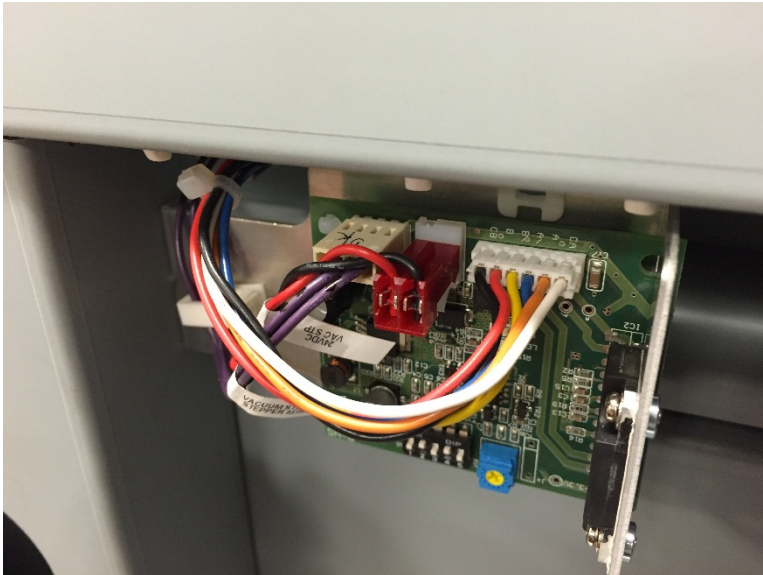

6. Remove the Stepper Driver bracket by removing the M4 Screws (2), and remove the Stepper Driver Bracket.

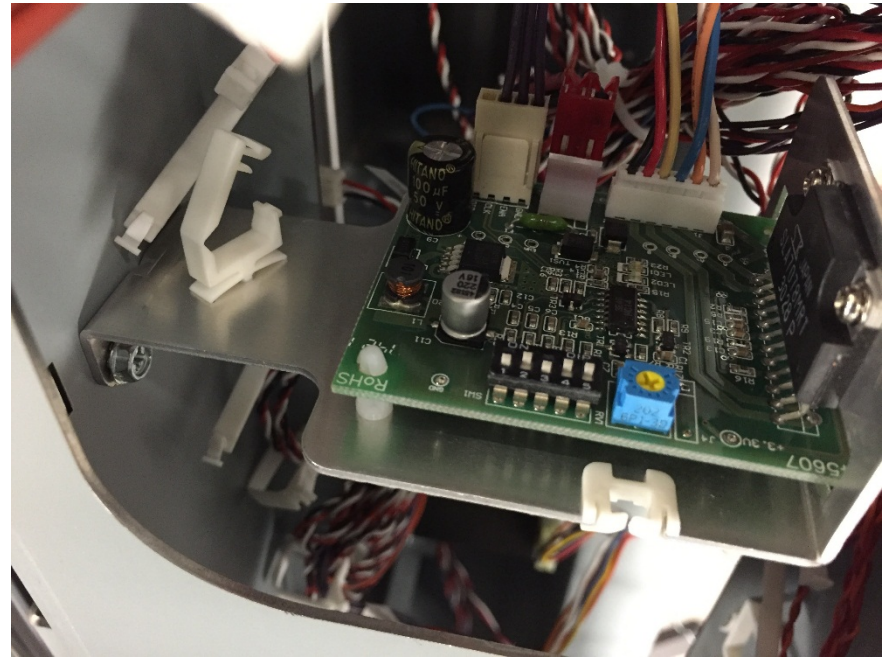

7. Remove the Stepper Driver from the mounting bracket by removing the M3 Screws (2) and depressing the tabs on the Standoff



## Installation Procedure

1. Attach the new Stepper Driver to the mounting bracket by securing it to the plastic Standoffs. Secure the Stepper Driver by tightening the M3 Screws.
2. Set the Stepper Driver Dip Switches to the appropriate values, referring to the table below.
3. Install the Stepper Driver Bracket using the M4 Screws (2).
4. Re-connect the Stepper Driver Cables.
5. Do REP 1.5 [Back Cover Replacement](#) to install the Back Cover, or REP 1.6 [Side Cover Replacement](#) to install the Side Cover.
6. Connect the Power Cord.
7. Power ON the eWire.

		1	2	3	4	5
Bind Path Motor	M3	OFF	ON	OFF	ON	ON
Vacuum Drive Motor	M5	OFF	ON	OFF	ON	OFF
Holder Linear Motor	M15	OFF	OFF	ON	OFF	OFF
Closer Linear Motor	M21	OFF	OFF	ON	OFF	OFF

## REP 9.7 Vacuum Fan Replacement

### PARTS LIST ON PL 5.26

Use this procedure to remove and install the Vacuum Fan.

#### Removal Procedure

#### WARNING

**Do not perform repair activities with the power on or electrical power supplied to the machine. Some machine components contain dangerous electrical voltages that can result in electrical shock and possible serious injury. See Section 0, page vi for other languages.**

1. Turn off Power to the eWire.
2. Disconnect the Power Cord.
3. Do REP 1.6 [Side Cover Replacement](#) to remove the Side Cover.
4. Disconnect the Vacuum Fan Cables.

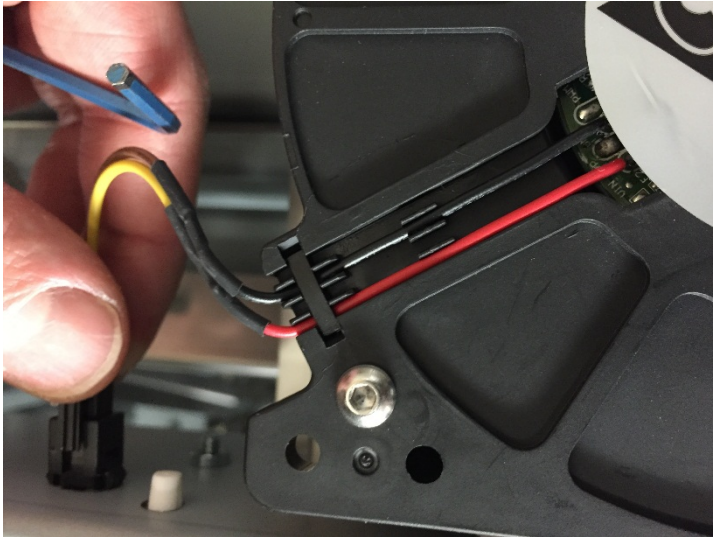

5. Remove the M4 Screws (4) securing the Vacuum Fan and remove the old fan.



#### Installation Procedure

1. Reverse the steps in the Removal Procedure
2. Connect the Power Cord.
3. Turn on power to the eWire.

## REP 9.8 Vacuum Fan Gasket Replacement

### PARTS LIST ON PL 5.26

Use this procedure to remove and install the gasket at the Vacuum Fan to Vacuum Module interface.

#### Removal Procedure

#### **WARNING**

**Do not perform repair activities with the power on or electrical power supplied to the machine. Some machine components contain dangerous electrical voltages that can result in electrical shock and possible serious injury. See Section 0, page vi for other languages.**

1. Turn off Power to the eWire.
2. Disconnect the Power Cord.
3. Raise the Transport Assembly and lift the Vacuum Stacker by pulling on the Vacuum Stacker handle.
4. Using a flat tool, remove the Fan Gasket from the mating surface.

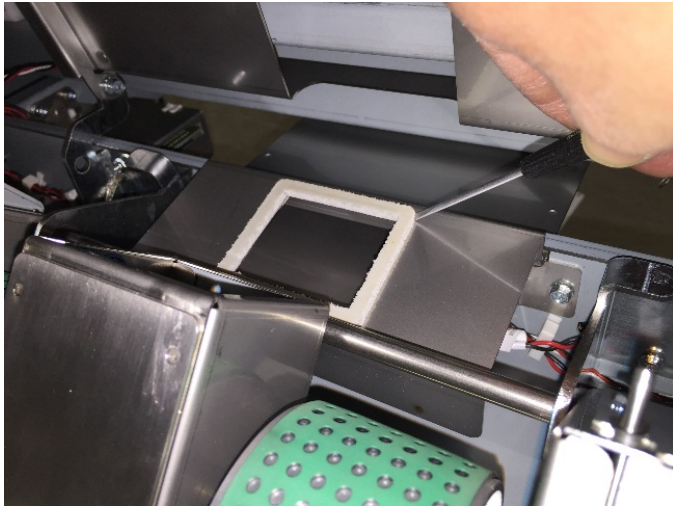

#### Installation Procedure

1. Clean the mating surface carefully with alcohol and a clean cloth. Remove any adhesive residue.
2. Align the new Gasket with the vacuum opening and press it down firmly to adhere it to the metal surface.
3. Lower the Vacuum Stacker and close the lid.
4. Connect the Power Cord.
5. Turn on power to the eWire.

## REP 9.9 Stacker Paper Detect Sensor S44 Replacement

### PARTS LIST ON PL 5.26

Use this procedure to remove and install the Stacker Paper Detect Sensor, S44.

#### Removal Procedure

#### **WARNING**

**Do not perform repair activities with the power on or electrical power supplied to the machine. Some machine components contain dangerous electrical voltages that can result in electrical shock and possible serious injury. See Section 0, page vi for other languages.**

1. Turn off Power to the eWire.
2. Disconnect the Power Cord.
3. Open the top cover and lift the lower paper path.
4. Lift the Vacuum module and lift the paper tray.
5. Remove the M4 Nuts (2) holding the sensor cover to the bottom of the paper tray.

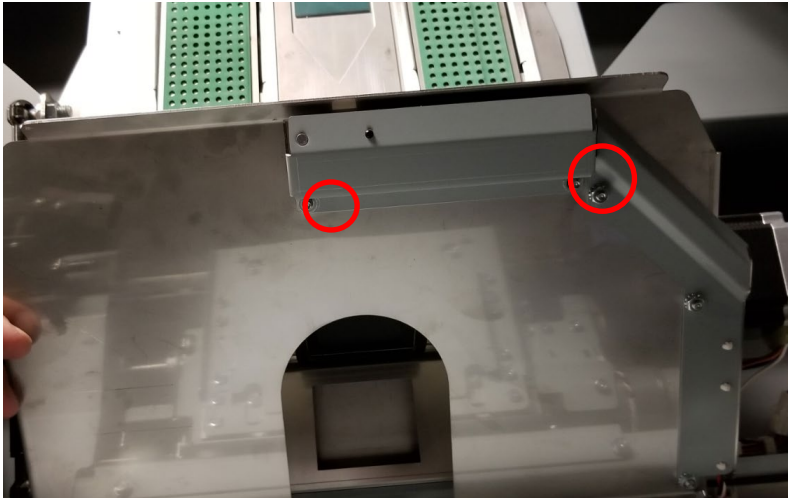

6. Remove the M3 Nut securing the sensor to the cover.



#### Installation Procedure

1. Reverse the steps in the Removal Procedure
2. Connect the Power Cord.
3. Turn on power to the eWire.

## 10. Book Drawer

### REP 10.1 Drawer Full Up Sensor Replacement S42

#### PARTS LIST ON PL 5.23

Use this procedure to remove and install the Book Drawer Full Up Sensor. There are two sensors, each consisting of two halves.

#### Removal Procedure

#### **WARNING**

**Do not perform repair activities with the power on or electrical power supplied to the machine. Some machine components contain dangerous electrical voltages that can result in electrical shock and possible serious injury. See Section 0, page vi for other languages.**

1. Switch power OFF to eWire.
2. Disconnect the Power Cord.
3. Pull the Book Tray all the way out of the eWire.
4. Do REP [1.7](#) to remove the Book Drawer Door.
5. The emitter PCB (2) is located on the front of the Book Drawer. Disconnect the Emitter PCB Cable.
6. Remove the emitter PCB (2) by removing the (2) M4 fasteners.
7. Remove the cover from the back of the Book Drawer by removing the M4 Screws (2) and the M4 Nuts (2).
8. Disconnect the receiver PCB cable.
9. Remove the receiver Mounting bracket by removing the M3 nuts (2).
10. Remove the Receiver PCB by removing the M4 fasteners (2).

#### Installation Procedure

1. Install the Receiver PCB and Emitter PCB and secure with the M4 fasteners (2).
2. Install the Receiver Mounting bracket and secure with the M3 Nuts (2).
3. Connect the Emitter and Receiver PCB sensor cables.
4. Reverse the procedure from the Removal Procedure to reconnect all covers.
5. Connect the Power Cord
6. Turn power ON to eWire.

## REP 10.2 Drawer Full Down Sensor Replacement S43

### PARTS LIST ON PL 5.23

Use this procedure to remove and install the Book Drawer Full Down Sensor.

### WARNING

**Do not perform repair activities with the power on or electrical power supplied to the machine. Some machine components contain dangerous electrical voltages that can result in electrical shock and possible serious injury. See Section 0, page vi for other languages.**

#### Removal Procedure

1. Switch power OFF to eWire.
2. Disconnect the Power Cord.
3. Slide the Book Drawer Tray all the way out of the eWire.
4. Remove the Book Drawer rear cover by removing the M4 Screws (2) and the M4 Nuts (2).
5. Disconnect the Sensor cable from the Sensor.
6. Remove the sensor bracket by removing the Screws (2).



7. Disconnect the Sensor from the bracket by removing the M3 Screw and remove the old sensor.

#### Installation Procedure

1. Reverse the Steps from Removal Procedure.
2. Connect the Power Cord
3. Turn power ON to eWire.

## REP 10.3 Book Drawer Full Sensor Replacement S45

### PARTS LIST ON PL 5.23

#### WARNING

Do not perform repair activities with the power on or electrical power supplied to the machine. Some machine components contain dangerous electrical voltages that can result in electrical shock and possible serious injury. See Section 0, page vi for other languages.

1. Switch power OFF to eWire.
2. Disconnect the Power Cord.
3. Remove the Book Drawer Side Cover by removing the M4 Screws (4).

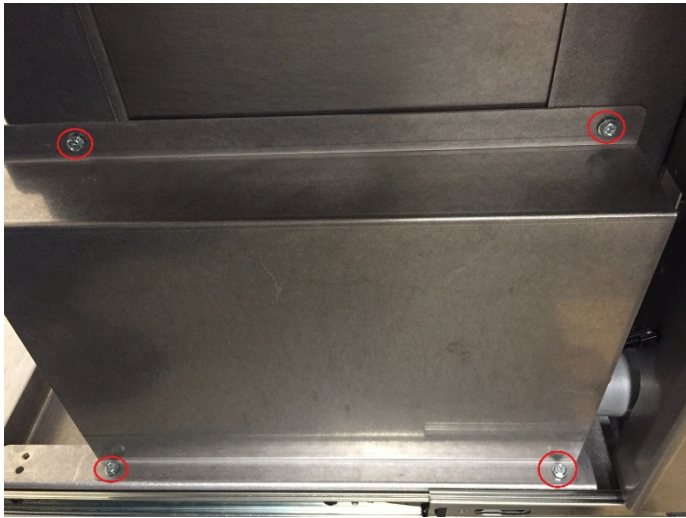

4. Remove the Sensor Bracket by removing the M4 nuts (2).



5. Remove the Sensor from the Bracket by removing the M2 Screws.

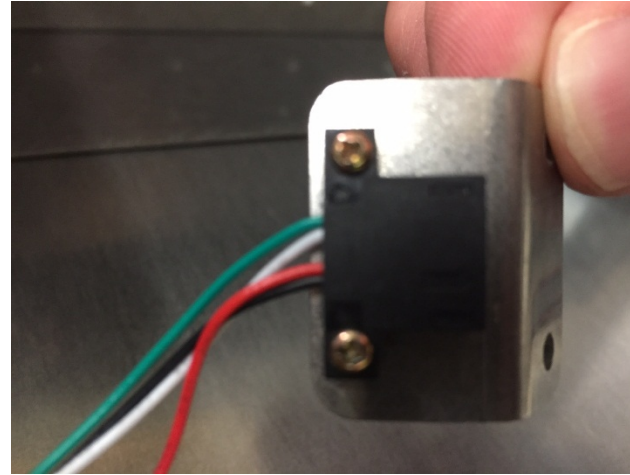

#### Installation Procedure

1. Attach the new Sensor to the Sensor Bracket using the M2 Screws (2).
2. Attach the Sensor Bracket using the M4 Nuts (2).
3. Replace the Book Drawer Side Cover.
4. Connect the Power Cord.
5. Power ON the eWire.

## REP 10.4 Book Drawer Drive Motor Replacement M19

### PARTS LIST ON PL 5.23

#### Removal Procedure

#### **WARNING**

**Do not perform repair activities with the power on or electrical power supplied to the machine. Some machine components contain dangerous electrical voltages that can result in electrical shock and possible serious injury. See Section 0, page vi for other languages.**

1. Turn off Power to the eWire.
2. Disconnect the Power Cord.
3. Slide the Book Drawer Tray all the way out of the eWire.
4. Remove the Book Tray Rear Cover by removing the M4 Screws (2) and M4 Nuts (2).
5. Do [REP 10.5](#) to remove the belt.
6. Disconnect the Motor Cable.

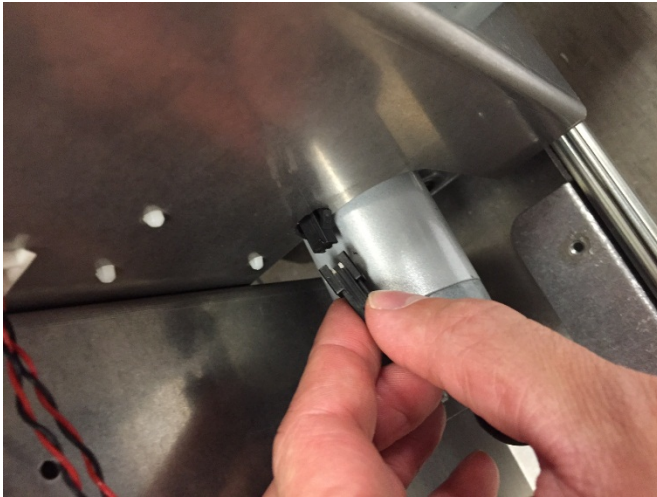

7. Remove the Motor Bracket by removing the M4 Nuts (2).

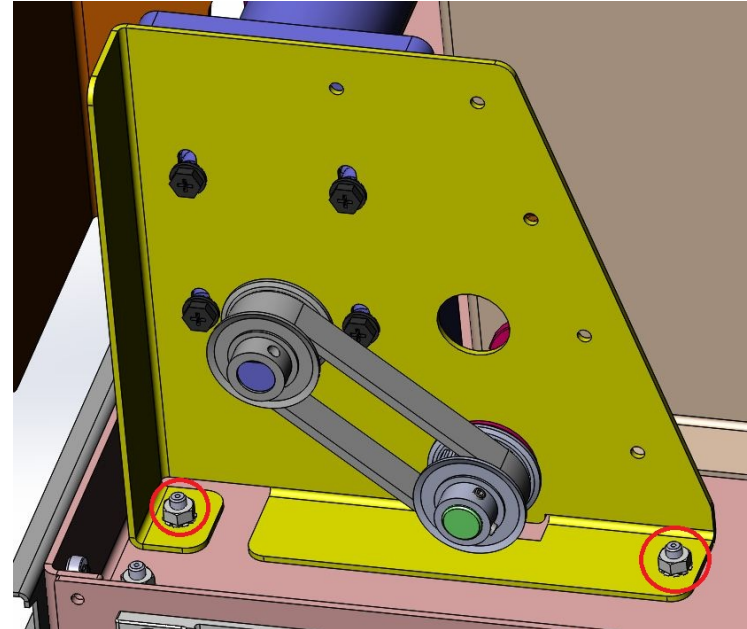

8. Remove the M19 motor by removing the M4 mounting screws (4).

#### Installation Procedure

1. Reverse the Steps in the Removal Procedure
2. Connect the Power Cord.
3. Turn on power to the eWire.



## REP 10.5 Book Tray Belt Removal Procedure

### PARTS LIST ON PL 5.24

Use this procedure to remove and install the Belt for the Book Tray Drive Motor.

#### Removal Procedure

#### **WARNING**

**Do not perform repair activities with the power on or electrical power supplied to the machine. Some machine components contain dangerous electrical voltages that can result in electrical shock and possible serious injury. See Section 0, page vi for other languages.**

1. Turn off Power to the eWire.
2. Disconnect the Power Cord.
3. Slide the Book Drawer Tray all the way out of the eWire.
4. Remove the Book Tray Rear Cover by removing the M4 Screws (2) and M4 Nuts (2).
5. Loosen the set screws on the Pulleys on the Motor Shaft and Drive Shaft.

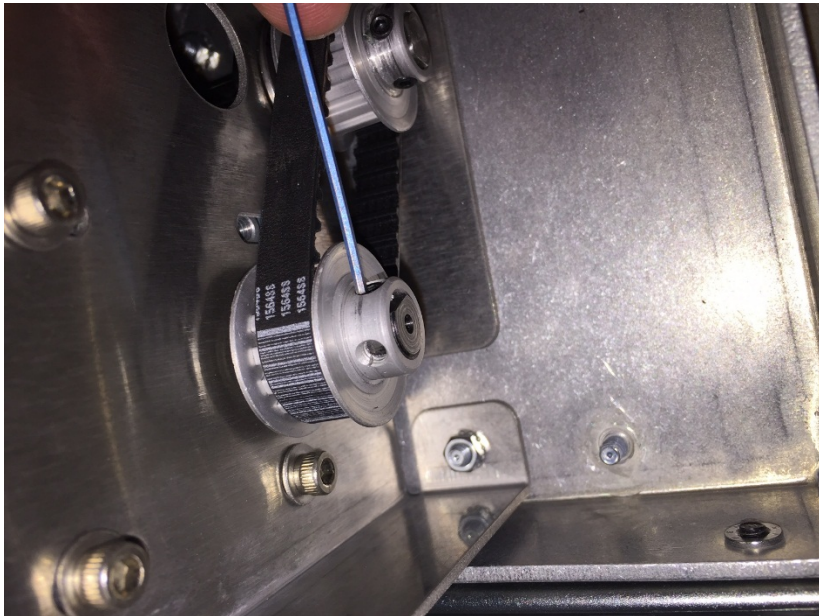

6. Slide the pulleys and Belt off the shafts and remove the Belt.

#### Installation Procedure

1. Wrap the new Belt around the Motor Shaft Pulley and Drive Pulley and slide the Pulleys onto their respective Shafts.
2. Secure the pulleys in place by tightening the set screws.
3. Replace the Rear Cover
4. Close the Door.
5. Connect the Power Cord.
6. Turn on power to the eWire.

## 11. Electrical Components

### REP 11.1 Main Control Board AC Replacement

#### PARTS LIST ON PL 5.27

Use this procedure to remove and install the PCB Control Board(s). Before replacing the Main Control board, you **MUST** backup the settings by performing the backup steps on GP 6.3.8.

#### Removal Procedure

### WARNING

**Do not perform repair activities with the power on or electrical power supplied to the machine. Some machine components contain dangerous electrical voltages that can result in electrical shock and possible serious injury. See Section 0, page vi for other languages.**

1. Perform GP 6.3.8 to back up the settings. Without this backup the eWire will not function correctly with the new board.
2. Do GP 6.3.8 Retrieve Log Data to store the eWire Log to USB
3. Switch power OFF to eWire.
4. Disconnect the Power Cord.
5. Do REP 1.5 [Back Cover Replacement](#) to remove the Back Cover.
6. Disconnect all connectors from the Main. Note the connector locations so you can replace them in the same position on the new board.
7. Remove the M3 Screws (10) from the Main Control Board and remove the Main Control Board.

#### Installation Procedure

1. Place the Main Control Board and Communication Board in position.
2. Secure the Main Control board by tightening M3 Screws (10)

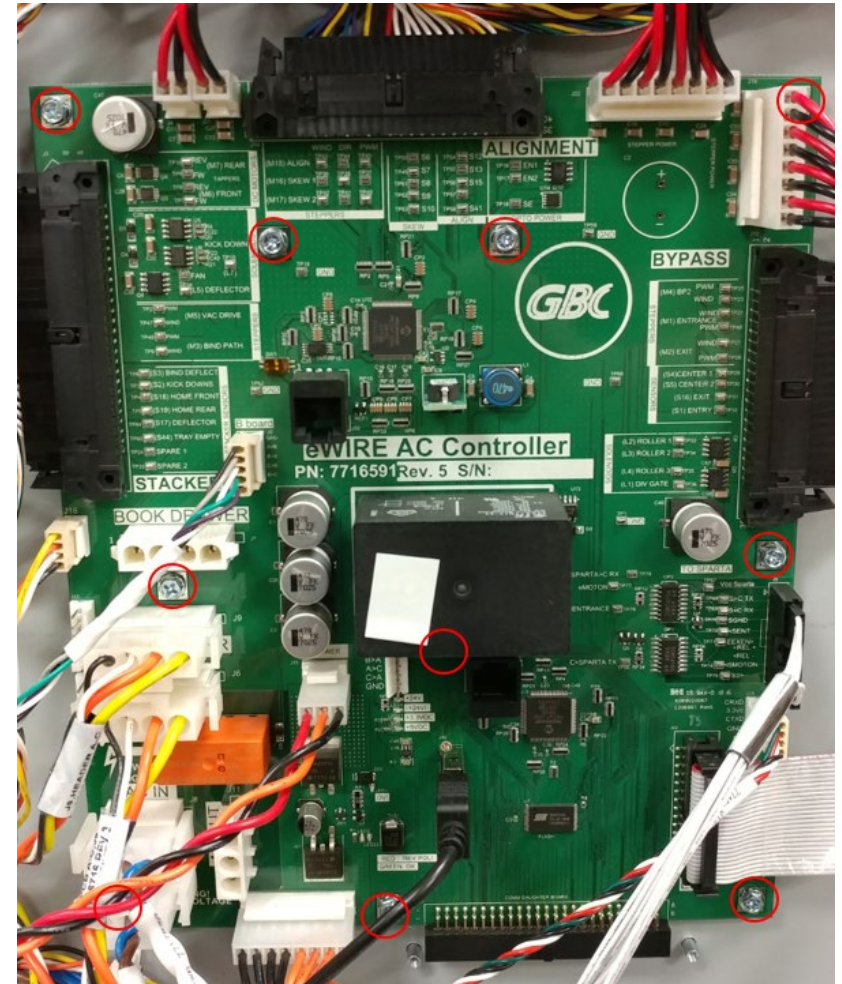

3. Re-connect all connectors to the Main Control Board. Refer to Section 7, Wiring for details.
4. Do REP 1.5 [Back Cover Replacement](#) to install the Back Cover.
5. Connect the Power Cord.
6. Power ON the eWire.
7. Perform GP 6.3.8 to restore the back up.

## REP 11.2 Main Control Board B Replacement

### PARTS LIST ON PL 5.27

Use this procedure to remove and install the Main Control Board B.

### WARNING

**Do not perform repair activities with the power on or electrical power supplied to the machine. Some machine components contain dangerous electrical voltages that can result in electrical shock and possible serious injury. See Section 0, page vi for other languages.**

1. Switch power OFF to eWire.
2. Disconnect the Power Cord.
3. Do REP 1.5 [Back Cover Replacement](#) to remove the Back Cover.
4. Disconnect the Connectors from the old Main Control Board B. Note the connector locations so you can return them to the same positions on the new Board.
5. Remove the M3 Screws (4) from the old Main Control Board B, and remove the PCB.

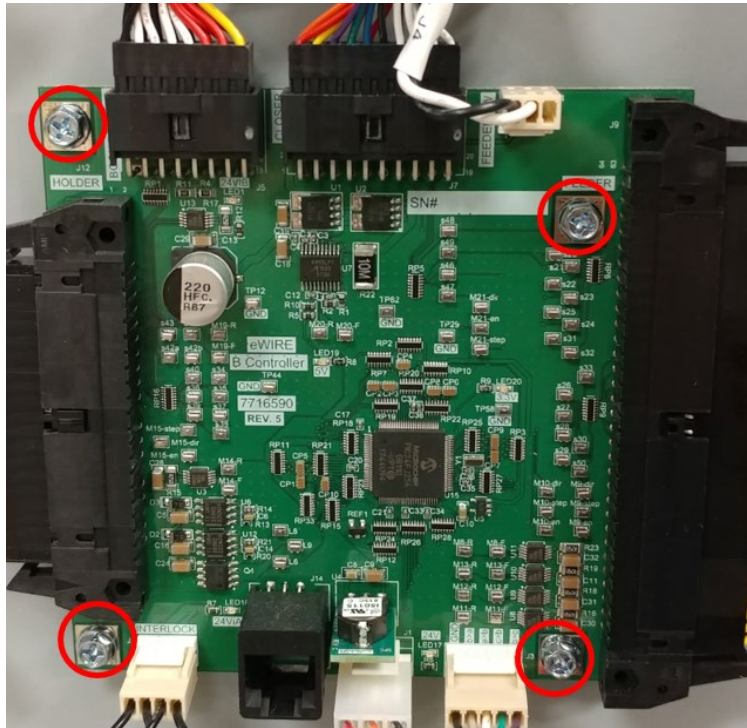

### Installation Procedure

1. Place new Main Control Board B in position and secure by tightening the M3 Screws (4).
2. Re-connect all connectors to the Main Control Board B. Refer to the below table for connector locations.
3. Do REP 1.5 [Back Cover Replacement](#) to install the Back Cover.
4. Connect the Power Cord.
5. Power ON the eWire.

## REP 11.3 24V Power Supply Replacement

### PARTS LIST ON PL 5.27

Use this procedure to remove and install the 24V Power Supply Assembly.

#### Removal Procedure

#### WARNING

Do not perform repair activities with the power on or electrical power supplied to the machine. Some machine components contain dangerous electrical voltages that can result in electrical shock and possible serious injury. See Section 0, page vi for other languages.

1. Turn off Power to the eWire.
2. Disconnect the Power Cord.
3. Do REP 1.5 [Back Cover Replacement](#) to remove the Back Cover.
4. Disconnect all connectors from the 24V power supply.



5. Slide the book drawer all the way out of the machine.

6. While carefully supporting the power supply, remove the M4 Screws (4) from the rear electrical panel plate. The Screws are located on the reverse side of the Power Supply.



7. Remove the Power supply from the electrical panel.

#### Installation Procedure

1. Position the new 24V Power Supply on the rear electrical panel.
2. Secure the new 24V Power Supply using M4 Screws (5).
3. Reconnect all connectors to the 24V power supply.
4. Do REP 1.5 [Back Cover Replacement](#) to install the Back Cover.
5. Close the book drawer.
6. Connect the Power Cord.
7. Turn on power to the eWire.

## REP 11.4 RFI Filter Replacement

### PARTS LIST ON PL 5.27

Use this procedure to remove and install the AC Filter Assembly.

#### Removal Procedure

#### **WARNING**

**Do not perform repair activities with the power on or electrical power supplied to the machine. Some machine components contain dangerous electrical voltages that can result in electrical shock and possible serious injury. See Section 0, page vi for other languages.**

1. Switch power OFF to eWire.
2. Remove the power cord
3. Note the location of the wires (3).

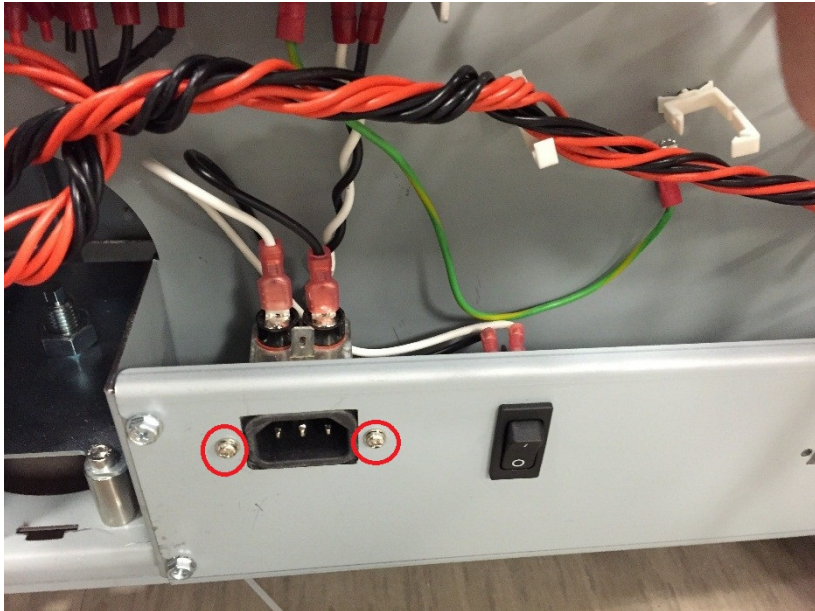

4. Remove the Wires (White/Black/Green) from the AC Filter.
5. Remove the M3 Screws (2) securing the AC Filter to the Electrical Panel.
6. Remove the AC Filter from the Electrical Panel by pushing it forward through the mounting plate.

#### Installation Procedure

1. Insert the AC Filter into the electrical panel and tighten the M3 Screws (2).
2. Connect the Wires (3) to the AC Filter, maintaining the previous locations.
3. Do [REP 1.5](#) to install the Rear Cover.
4. Connect the Power Cord.
5. Power ON the eWire.

## REP 11.5 Power Switch Replacement

Use this procedure to remove and install the Power Switch.

### Removal Procedure

#### **WARNING**

**Do not perform repair activities with the power on or electrical power supplied to the machine. Some machine components contain dangerous electrical voltages that can result in electrical shock and possible serious injury. See Section 0, page vi for other languages.**

1. Press the Power switch to OFF position.
2. Disconnect the Power Cord.
3. Do REP 1.5 [Back Cover Replacement](#) to remove the Back Cover.
4. Note the wire connection locations (White/Black/Green) on the back of the Switch.



5. Disconnect the wires from the back of the Switch
6. Press the Tabs and remove the Switch from the Panel.

### Installation Procedure

1. Install the Switch in the Panel by pressing into the mounting hole until the tabs lock securely into place.
2. Re-connect the wires, maintaining the wire locations as noted during removal.
3. Do REP 1.5 [Back Cover Replacement](#) to install the back cover
4. Connect the Power Cord.
5. Power ON the eWire.

## Adjustments

### ADJ 1.1 Element Position Skew Adjustment

#### Inspection Procedure

- 1) Locate the Element Height Setup Tool, which is attached to the eWire Book Tray Door.

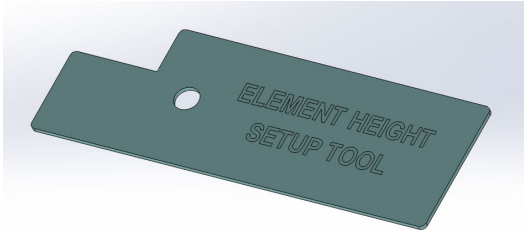

- 2) Pull out the Element Feeder tray, and insert a cheat into the interlock for the Element Feeder Door.
- 3) Enter the Service Menu, and select **Function Tests → Pushover → Out**. This will move the Expanding T to its forward position.
- 4) Using the Setup Tool, press the front flat surface of the tool against the Element Feeder face. The notch on the Setup Tool is set to 16 mm, which is the correct position of the Expanding T Out.



- 1) Repeat the process on the front and rear of the machine. If the Expanding T front face is not touching the tool or the tool is not touching the blue feeder track face, refer to the adjustment steps below. If both of the tool faces are touching the expanding T and blue feeder track, return to the procedure that directed you here.

#### Adjustment Procedure

- 1) Remove the screws and nuts (5 total) from the locations shown and remove the Covers.

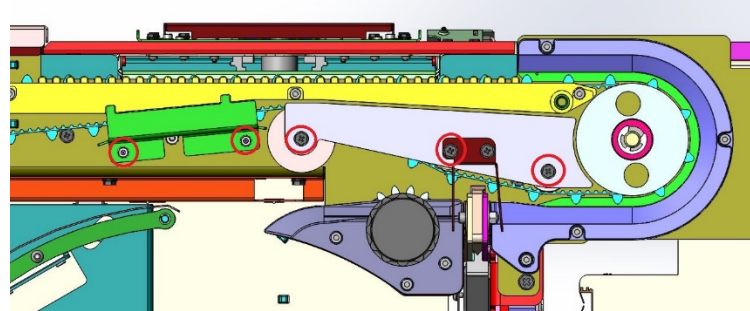

- 2) Locate the screws indicated in the picture below. Loosen the lock nuts with a wrench. Turn the screws clockwise to decrease Expanding T Out. Turn the screws counter-clockwise to increase Expanding T Out. If the Expanding T Out position is skewed, try adjusting only one screw to correct it.

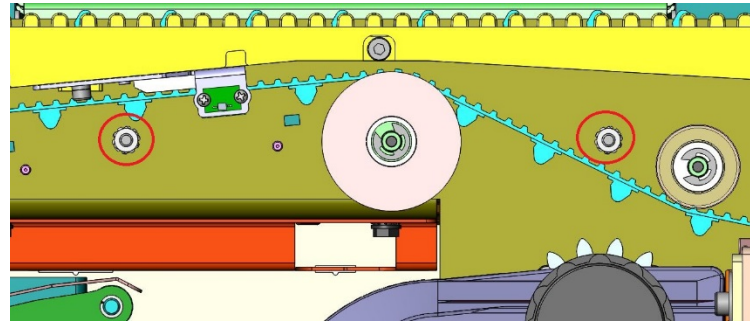

- 3) After adjustment is complete, tighten the lock nuts. Repeat the Inspection Procedure to determine if the desired location has been reached.
- 4) If additional adjustment is needed, repeat steps 2 and 3. If the position is now correct, return to the procedure that directed you here.

## ADJ 1.2 Element Slack Detection Adjustment

Use this procedure to adjust the sensitivity of the Element Slack Detect Lever Assembly.

- 1) Switch power OFF to the eWire.
- 2) Disconnect the Power Cord.
- 3) Do GP 6.13 to remove the Supply Spool, Rewind Spool, Spool Detect Cover, and Rear Baffle.
- 4) Loosen, but do not remove, the M3 screw holding the Weight in place on the Element Slack Detect Lever Assembly and slide the weight towards the rear of the machine so that the Element Slack Detect Lever is in the home (UP) position then finger tighten it.

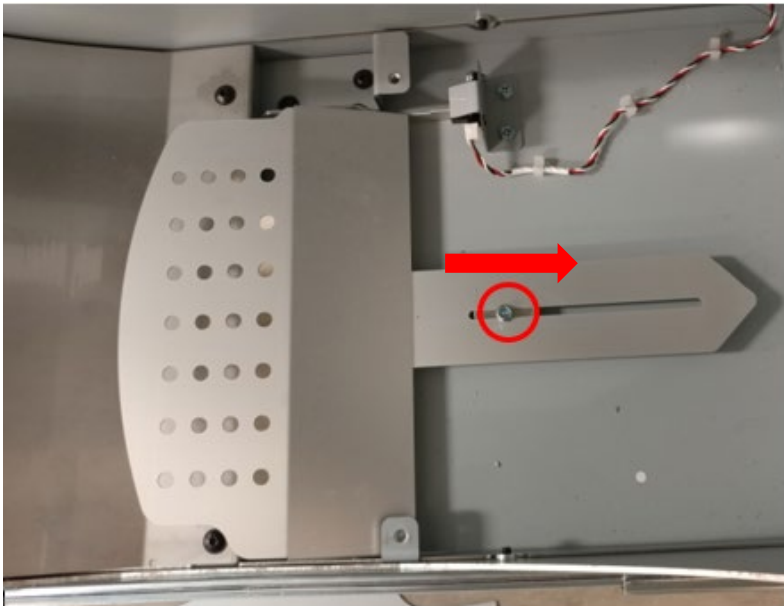

- 5) The home position of the Element Slack Detect Lever under normal operation should be in the position where the Element Slack Sensor (S20) is not blocked.

**Adjusting Down Stroke:** Place two M3 screws that were used to secure the covers in step 3 in the positions shown. The Element Slack Detect Lever should go fully down. If it does not, adjust the weight towards the front of the machine in very small increments until the Detect Lever goes down then finger tighten screw. Test a few times to make sure the adjustment is correct.

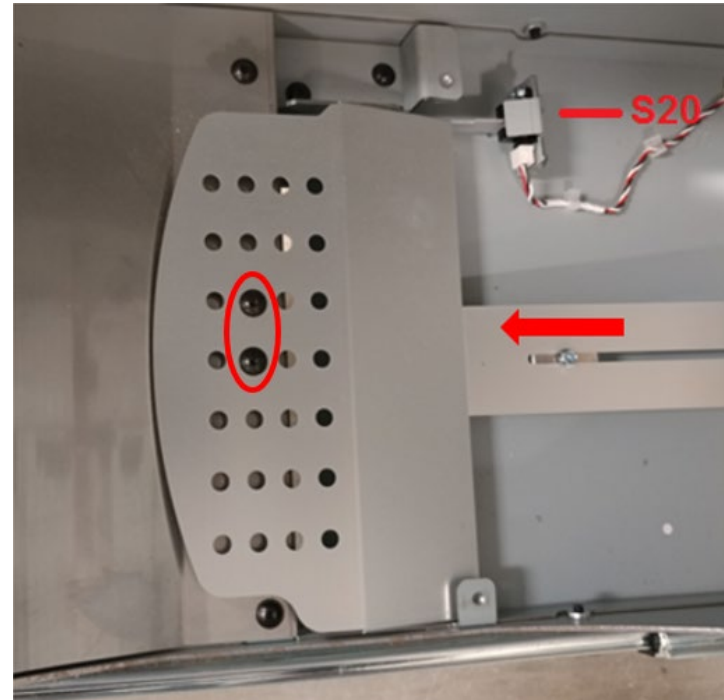



- 1) **Adjusting Up Stroke:** Now remove the one screw as shown. The Element Slack Detect Lever should now come fully up. If it does not, adjust the weight towards the rear of the machine in even smaller increments than performed in step 5 until Element Slack Detect Lever comes up, then finger tighten screw. After adjusting the up stroke, re-test step 5 by adding the second screw to the Element Slack Detect Lever to make sure it goes down (you may have to tap on it or lightly blow on it to make it go down, but it should stay down, then come back up when you remove the second screw again). Repeat Up and Down Stroke tests until satisfied. Tighten the screw that holds the counter weight.

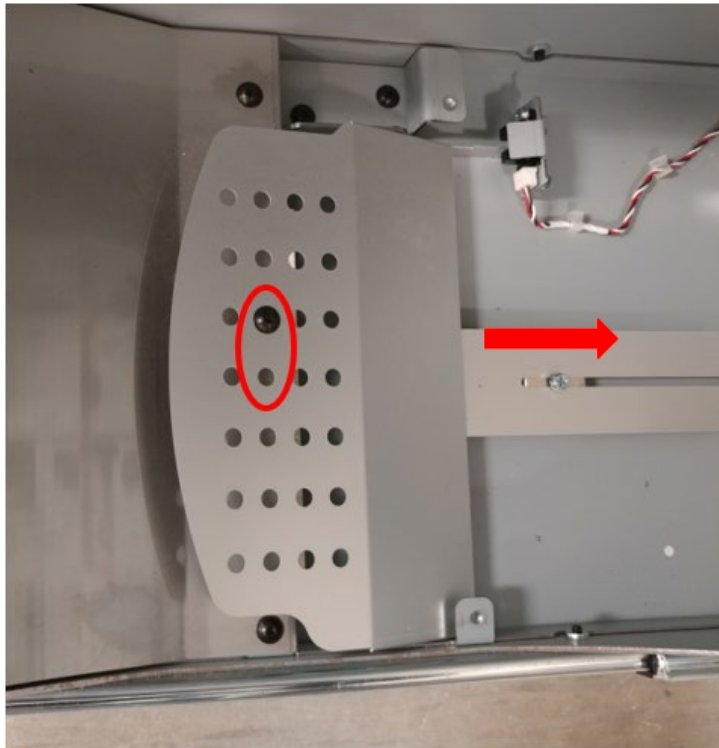

- 2) Do GP 6.13 to install the, Rewind Spool, Spool Detect Cover, and Rear Baffle.
- 3) Connect the Power Cord.
- 4) Turn power ON to the eWire.
- 5) Do GP 6.7 to Install a Supply Spool of the smallest size element available onsite.
- 6) Do GP 6.3.4 to perform the Feed Element functional test and verify the Element Slack Detect Lever Assembly moves correctly while an element is being fed.

### ADJ 1.3 Holder Mating To Element Feeder

For proper operation, the element holder module should mate to the element feeder without any hesitation or mechanical resistance. The two locating pins on the element holder should smoothly engage the element feeder.

#### Adjustment Procedure

- 1) Perform function test Holder to Xfer GP 6.3.4 to mate the holder to the element feeder.  
**Service Settings Menu → Function Tests → Holder to Xfer**
- 2) If the element holder locating pins do not slide smoothly into the element feeder locating holes (See Fig 1), then the alignment needs to be corrected. This can also be checked by manually moving the holder to make the pins move slowly in and out of the feeder location holes
  - a) Check the *horizontal* alignment as shown in Fig 2.A and Fig 2.B.
    - i) If an adjustment is needed follow ADJ 1.15
    - ii) After adjustment, attempt to engage the holder into the element feeder by hand again while checking the alignment.

Fig 1

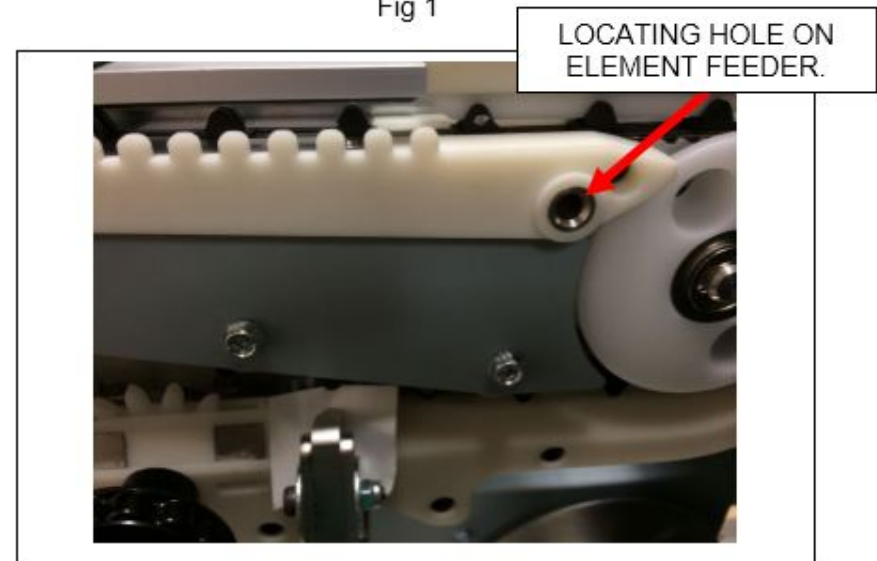
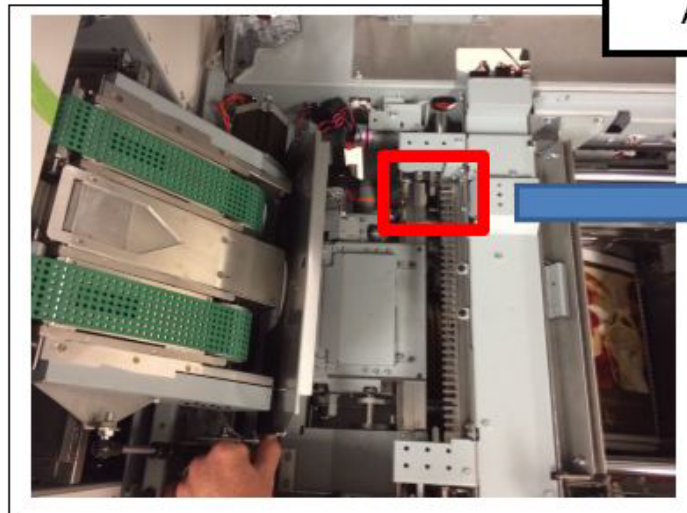
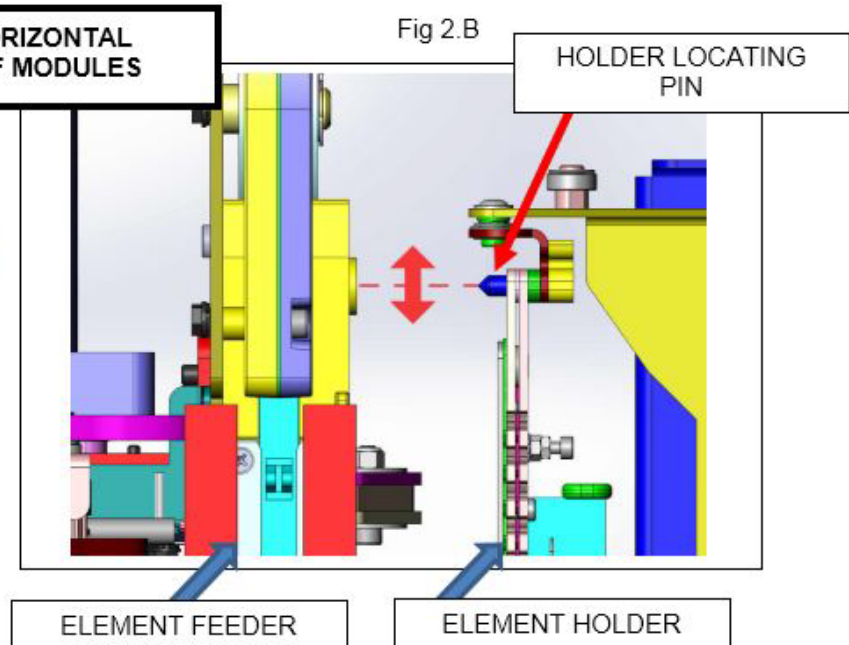

Fig 2.A



CHECKING HORIZONTAL ALIGNMENT OF MODULES

Fig 2.B



b) Check the Vertical alignment as shown in Fig 3.B.

- i) After moving the element holder into the element feeder, check the engagement in the vertical direction. If the two do not engage smoothly and at the correct height then an adjustment is needed.
- ii) Performing Adjustment.
  - (1) Move the element holder into the element feeder and leave the two engaged.
  - (2) Loosen the two screws on the *Height Adjustment Bracket* as shown in Fig 3.C.
  - (3) Insert a flat head screw driver and **very gently** raise the *Height Adjustment Bracket* (Fig 3.D) until it makes contact with the bearing/CAM follower in the track. Do not apply excessive pressure, contact is all that is needed with the bearing.
    - (a) While applying pressure, to lightly raise the bracket, tighten the two screws.
  - (4) Perform the same check and adjustment on the rear of the machine (not shown).
  - (5) After adjustment of the front and rear, by hand move the element holder and check for smooth engagement with the element feeder.

Fig 3.B

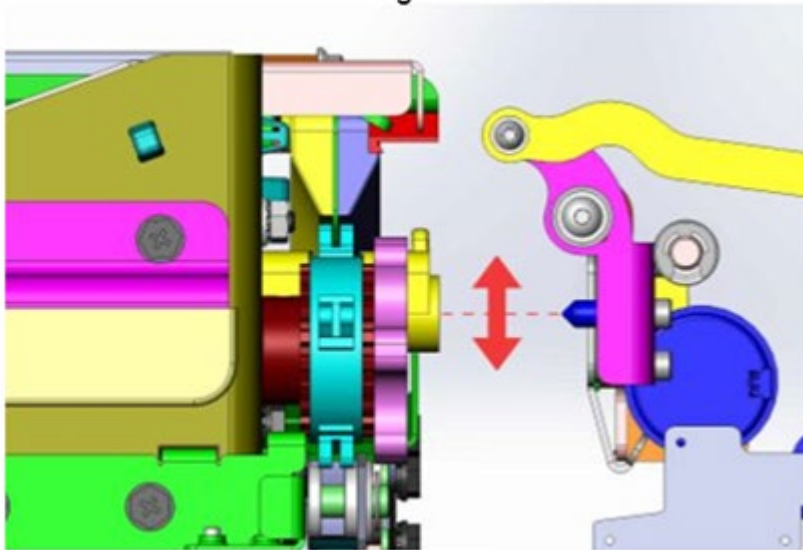

Fig 3.C

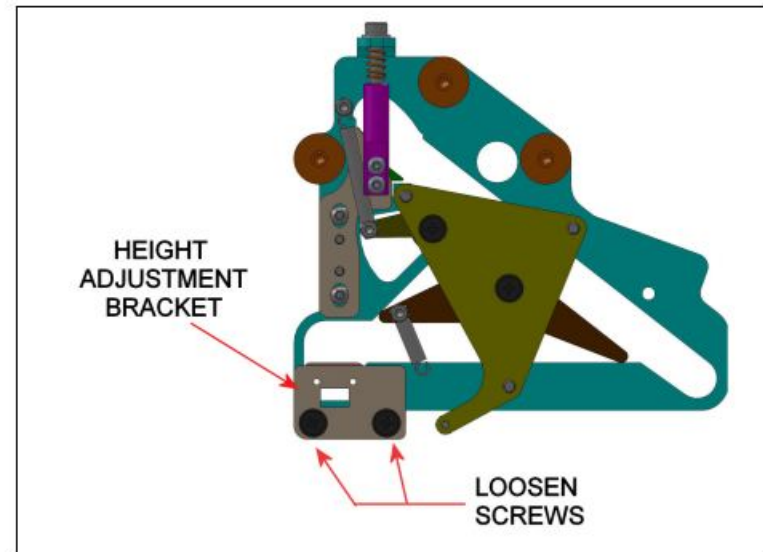
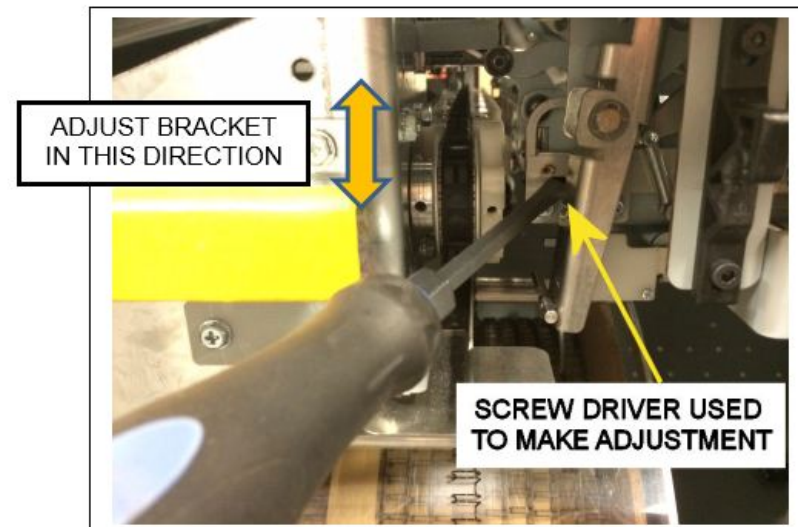

Fig 3.D



#### ADJ 1.4 Element Feed Belt Home Position

To properly feed an element, the belt tooth must enter/mesh with the element at the proper position. The Feed Belt Home setting controls the point where the belt meshes with the wire openings.

##### Inspection Procedure

- 1) Open the element feeder and cheat the safety interlock.
- 2) Enter the service menu of the eWire LCD.
- 3) Navigate through the menus as follows:
  - a) **Service Settings Menu → Feed Home Belt**
  - b) Press the **ENTER** button twice to home the belt.
- 4) Check the stop position of the belt tooth.
  - a) If necessary, **ENTER** can be pressed 2X again to check the belt position repeatedly.
- 5) The belt tooth should be slightly off center from the alignment hole. The tooth position should be about 1 mm in front of the hole as shown.
- 6) To confirm the mesh is correct, run a feed element per Section 6.3.4 Feed Element and carefully watch the belt tooth where it engages with the wire. The tooth should slide easily into the gap of the wire. If the tooth pushes against the wire, it is likely not set to the correct position.

##### Adjustment Procedure, Fine (for minor adjustments) (Recommended):

- 1) Open the element feeder and cheat the safety interlock.
- 2) Do GP 6.3.13 to access the Feed Belt Home adjustment menu (Fig 2)
- 3) Using the **up/down arrows**, change the value to change the belt home position value.
- 4) After making an adjustment, press the **ENTER** button twice to cause the belt to home. Check the belt tooth location relative to the alignment hole. It should be approximately 1 mm in front.
- 5) If the tooth position looks correct relative to the alignment hole, verify the setting by watching the element tooth engage with the wire as described in the Inspection Procedure. If the belt tooth doesn't engage easily, adjust the Feed Belt Home value until it does.

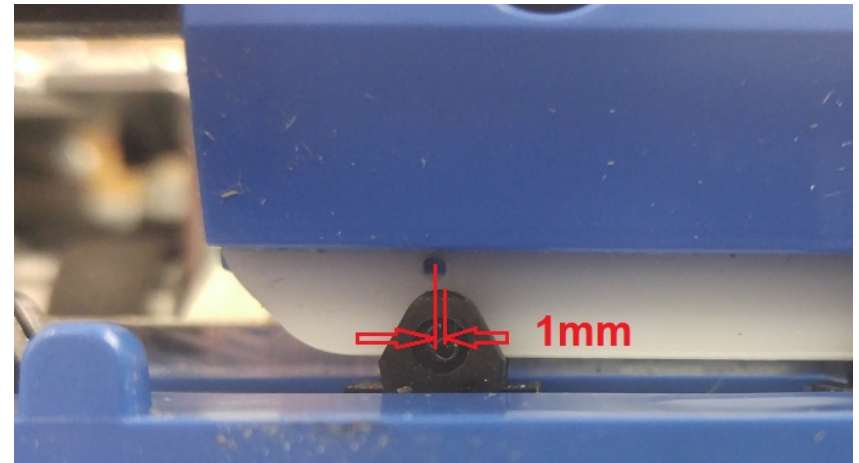

Fig 1



Fig 2

### Adjustment Procedure, Coarse (Only use when replacing S25):

If S25 is replaced, the Feed Belt Home position must be set to roughly the correct value using the procedure below. After coarse adjustment is complete, the final value is set by the fine adjustment procedure.

- 1) Begin by setting the belt home value on the LCD screen to a value of 0.
- 2) Open the element feeder and cheat the safety interlock switch.
- 3) Remove the cover shown in Fig 3 by removing the two M3 nuts.
- 4) Loosen (do not remove) the M3 screw securing the belt home sensor.
- 5) Slide the sensor bracket a slight amount to the left or right to affect the belt home position, then tighten the M3 screw.
- 6) Check the belt home position as per the **Inspection Procedure** mentioned earlier in this section.
- 7) Adjust the sensor bracket position and perform the inspection procedure again until the belt home position is roughly correct.
- 8) Once the position is near the correct position, install the cover previously removed (Fig. 3).
- 9) Perform the **Fine Adjustment** of the belt home position as defined earlier in this section.

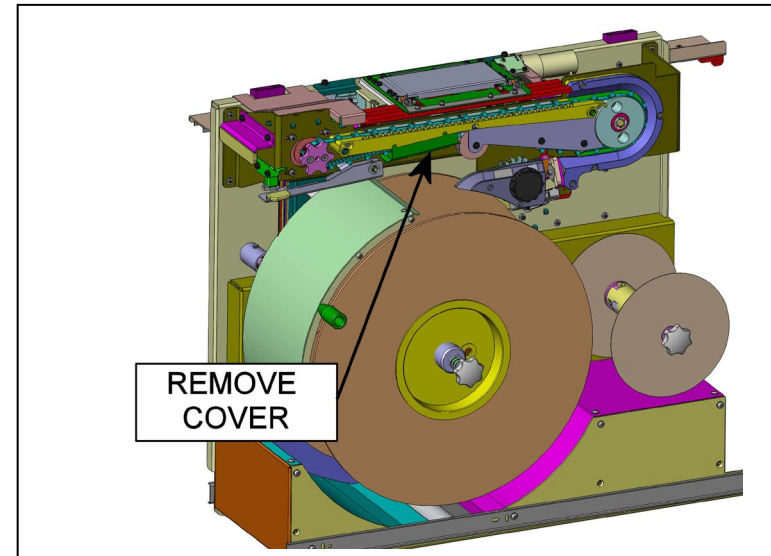

Fig 3

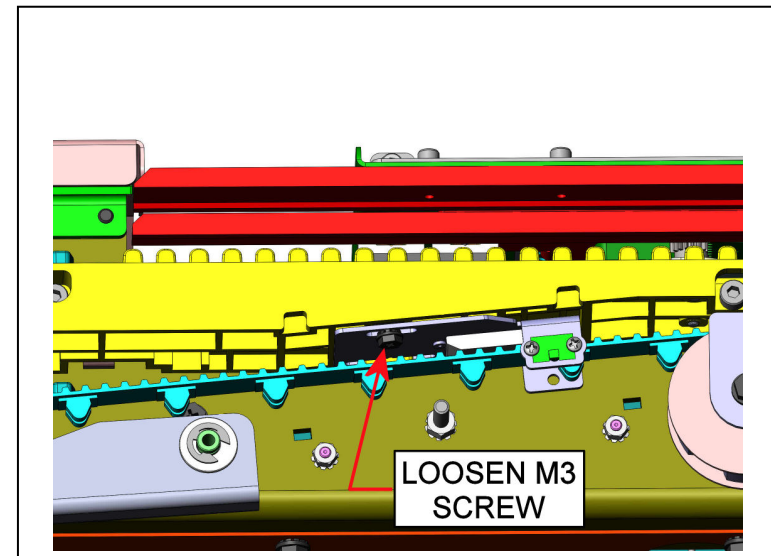

Fig 4

### ADJ 1.5 Book Drawer Closed Position

To ensure that the completed books drop into the book drawer from the closer module, the book drawer must be centered within the machine.

#### Inspection Procedure

- 1) Open the top cover and lift up the lower paper transport.
- 2) With the book drawer closed, inspect the position of the book drawer in regards to the opening in the machine.
- 3) If the book drawer is not well centered, an adjustment is required.

#### Adjustment Procedure

- 1) Open the book drawer and locate the book drawer stop latch bracket.
- 2) Loosen the screws securing the bracket.
- 3) Shift the bracket in the direction that you desire to move the book drawer, then tighten the screws.
- 4) Close the book drawer and inspect its position as defined in the **Inspection Procedure** section mentioned above.

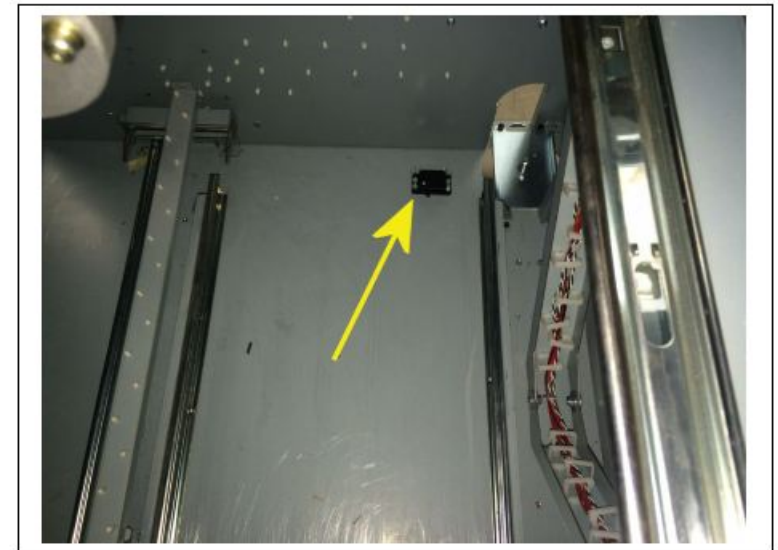
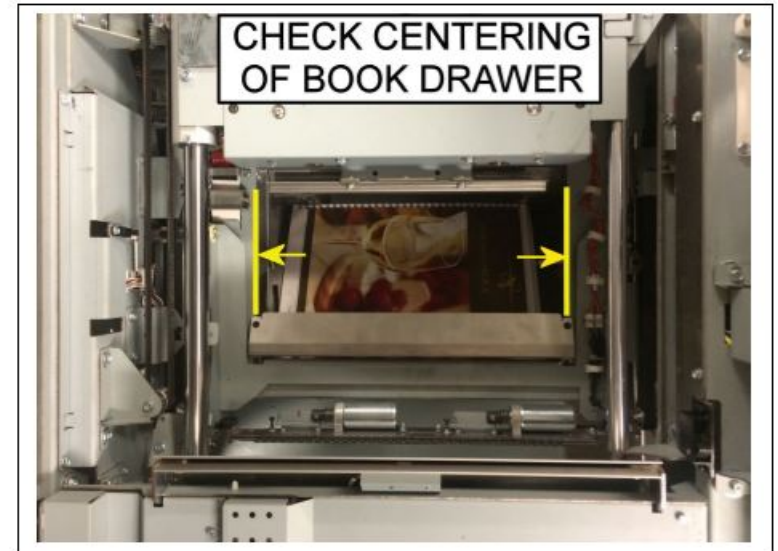

## ADJ 1.6 Timing Belt Tension Adjustment

Maintaining proper tension on the Timing Belt is critical to proper operation of the drive belt. If the belt is too loose, the belt will slip or possibly become worn. If the belt is too tight, it will not move freely. This procedure can be used for all belts within the eWire.

### Inspection Procedure

- 1) Identify the timing belt.
- 2) Apply pressure to the Timing Belt and check the amount of deflection. If the belt does not deflect at all and seems taut, the belt is likely too tight. If the belt appears to be strained, it is likely too tight.
- 3) Apply pressure to the Timing Belt and measure the amount of deflection. For longer Belts, slightly more deflection is allowable compared to short belts but the belt should not deflect excessively. If excessive deflection is noticed, or the belt teeth appear frayed, the belt is likely too loose. Refer to the guidelines below
  - a) Belt length <100 mm: 1-2 mm deflection
  - b) Belt length >100 mm, <500 mm: 3-5 mm deflection
  - c) Belt length > 500 mm: 6-8 mm deflection

### Adjustment Procedure

- 1) Identify the adjustment location for the Timing Belt.
  - a) If the belt has a Tensioner Assembly, use the tensioner to adjust belt tension.

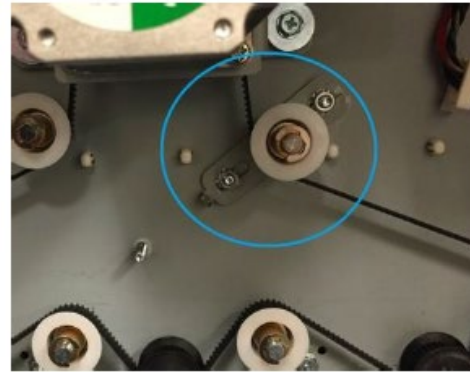

- b) If the motor bracket has slotted screws, loosen the motor mounting screws, and slide the motor back or forward to adjust tension.
  - c) If no slotted adjustment location is noted, loosen all screws that secure belt pulley locations and apply pressure to slightly adjust the pulley position. Secure the screws once proper tension is attained.
- 2) Tighten all screws and verify the belt tension as indicated in **Inspection Procedure**.
- 3) If it is impossible to achieve proper tension, replace the Timing Belt with a new one.

## ADJ 1.7 Interlock Flag Adjustment

If a CLOSE DOOR, CLOSE TRAY, or CLOSE LID message is shown even when the door is closed, or the message occurs during operation, it may be necessary to adjust the Interlock Flag.

### Inspection Procedure

- 1) Check to see if the CLOSE DOOR, CLOSE TRAY, or CLOSE LID message is shown even when the door is closed. If the message is shown when the door is closed, or you need to press extra hard on the door to make the message go away, the interlock flag may need adjustment.
- 2) If the CLOSE DOOR, CLOSE TRAY, or CLOSE LID shows up during operation, or occurs intermittently, the interlock flag may need adjustment.
- 3) If scoring is noticed on the interlock switch due to the interlock flag rubbing on the hub of the interlock, the interlock flag may need to be adjusted.
- 4) If the door does not appear to close all the way, but sticks out near the interlock location, the Interlock Flag may need adjustment.
- 5) Visually inspect the Interlock Flag position when the door is closed. The Flag should stop 1-2 mm from bottoming out.

### Adjustment Procedure

- 1) Open the door and locate the Interlock Flag. This is the metal component that presses the Interlock switch to keep it closed.
- 2) If the interlock is hitting the side rails of the interlock, loosen the M3 Screws (2) shown in red securing the Interlock Flag to the Adjustment Plate.
- 3) If the flag needs to press the interlock in more or be pulled back to allow the door to fully close, loosen the M3 Screws Nuts (2) shown in yellow securing the Adjustment Plate to the door.



- 4) Shift the Flag Plate forward, back, or laterally as needed to adjust the resting position of the Interlock Flag Plate within the Interlock Switch. The flag should be 1-2 mm short of bottoming out on the Interlock Switch when in the resting position and centered between the rails.
- 5) Tighten the screws and close the door to confirm the Interlock is operating as expected.



### ADJ 1.8 Element Hook Position Adjustment

Use this procedure to adjust the eWire alignment and deflector timing to ensure that the punched holes are centered on the wire loops during hooking. The Punched Hole Position Check Tool should be used to aid in making the adjustments and measurements described in this section.

#### Inspection Procedure

1. Remove the eWire die from the punch.
2. Remove pins 2 and 33 if using A4 paper or pins 3 and 31 if using LTR. Refer to the PUNCH Manual for reference on how to remove a pin.
3. Reinstall the eWire die in the punch.
4. Do GP 6.2.2 to decrease the CLOSING value by 4 or to the lowest value possible. Make a note of the initial setting.

#### User Settings Menu → Closing

5. Run a single book, with 3 sheets. Paper weight must be between 75 and 90 gsm. Do not use covers. When setting up this print job, run a test sheet that is punched, but not bound to verify acceptable sheet curl see Book Quality Section 3.5.2. Minimizing curl will improve the accuracy of the following procedure. If necessary, adjust printer settings to reduce curl.
6. Remove the book from the book drawer taking note of its orientation. Depending on the current settings for Deflector Timing, Alignment and Skew, a J244 or J202 jam may occur from a sheet/s remaining in Area 2.
  - Deskew: **Service Settings Menu → Deskew Adjust**
  - Deflector: **User Settings Menu → Deflector**
  - Alignment: **User Settings Menu → Alignment**

7. Twist and pull the element off the sheets taking care not to tear them.

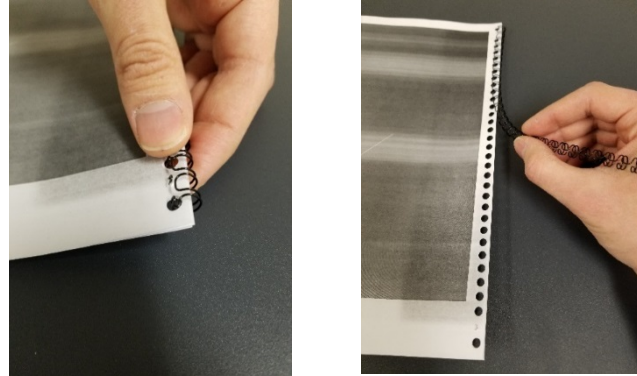

8. Take the first sheet in the stack (the one that was touching the tray) and position it on the Punched Hole Position Check Tool found on the inside of the Book Drawer. The side of the sheet that was facing the tray should be face up. You should see a small hole or an indent in the positions of the removed pins.
9. Using a straight-edge, draw a line from the center of the small holes or indents parallel with the trail edge of the sheet to the holes either side.
10. Draw another line from the center of the small holes or indents to the trail edge of the sheet perpendicular to the trail edge of the sheet.

11. Adjust the sheet so that the small hole or indent matches the pictures below. The edge of the sheet should be collinear with the horizontal black line and circular or square markings should match up with the punched holes. Following the 1mm markings on the tool, the optimal position for the small holes are indicated by the wider black marks.

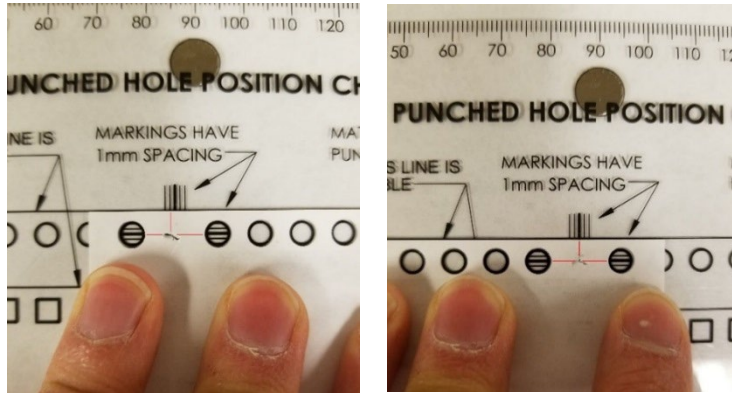

**NOTE: When changing the DESKEW ADJUST and ALIGNMENT settings these values correspond to all element sizes. When changing the DEFLECTOR setting this value only corresponds to the currently loaded element size.**

12. Check and correct the sheet skew. Do GP 6.1.3 to access the DESKEW ADJUST setting.
- If the small hole on the right is too close to the edge and the small hole on the left is too far away decrease this value by 1.
  - If the small hole on the right is too far away from the edge and the small hole on the left is too close increase this value by 1.
- Repeat step 5-6 and 12 until the holes are the same distance from the trail edge, they do not need to be the correct distance.

**Both small holes are the same distance from the edge of the sheet**

**Yes-** Go to Step 13  
**No-** Repeat this step

13. Check and correct the deflector timing and alignment. Do GP 6.1.2 to access the DEFLECTOR setting and the ALIGNMENT setting.
- A compass is provided on the Punched Hole Position Check Tool to assist in determining the direction of the needed adjustment. The arrow pointing in the direction the small hole needs to move in order to be in its optimal position has a + or a – next to it and either the

word DEFLECTOR or ALIGNMENT. + means the value should be increased in mm. – means the value should be decreased in mm.

Make a small adjustment to the appropriate setting then repeat Step 5-6 and 13.

**The small holes are in their optimal positions**

**Yes-** Go to Step 14

**No-** Repeat this step

14. Remove the die from the punch, reinsert the pins and reinstall the die. Run books to verify the issue is corrected.

**Issue is corrected**

**Yes-** Return to normal operation

**No-** Return to the trouble shooting step that directed you here.

## ADJ 1.9 Holder Rotate Adjustment

The Holder rotation linkage can be adjusted to ensure the Holder is properly vertical when in the vertical position or horizontal when in the horizontal position. Follow the steps in this section to verify that the Holder Rotate linkage is operating as expected.

### Inspection Procedure

- 1) Do GP 6.3. to access the Functional Tests menu. Select the Holder Rotate functional test, which will allow you to move the Holder into a vertical or horizontal position.

### Service Settings Menu → Function Tests → Holder Rotate

- 2) Cycle the Holder from vertical to horizontal several times. Ensure that the linkage moves smoothly. Check the bars in the linkage to see if any of them are bent or loose.
- 3) With the linkage in the Horizontal position, ensure that the Holder face is flat. A small level can be used for this purpose. The Element Height Setup Tool lever can be used for this.

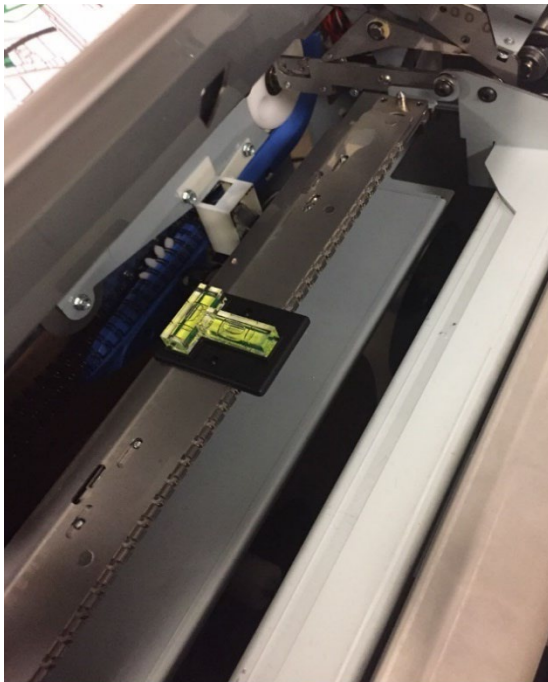

## Adjustment Procedure

- 1) Fine adjustment to the Holder Vertical or Horizontal position can be made by adjusting the setscrew(s) on the Holder yoke. Note that there is a setscrew for both vertical and horizontal adjustment.

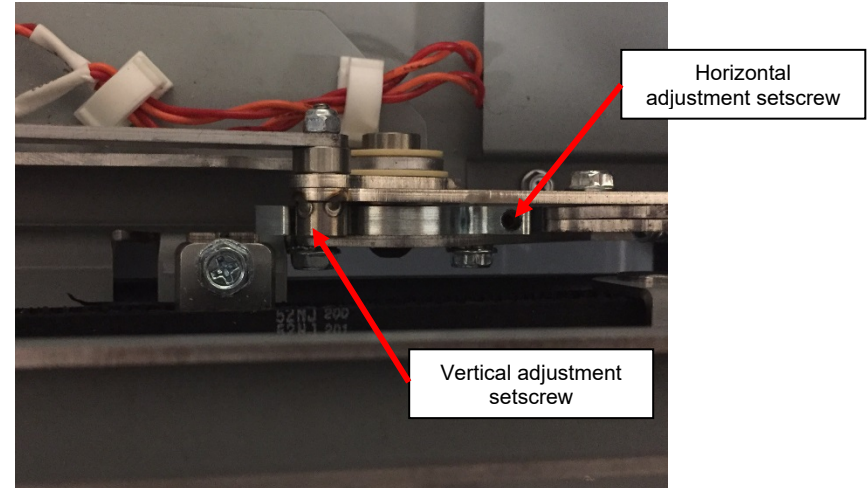

- 2) In some cases, the Holder may need to be adjusted slightly past horizontal to achieve better closing roundness.
- 3) Repeat this process until the proper positions are reached for both vertical and horizontal Holder positions.
- 4) Return to the RTP that brought you here.

### ADJ 1.10 Element Tip Height Adjustment

Use the following procedure to ensure that the Element wire tip position is correct, relative to the paper path. If the wire tips are too high or too low, jams or mishooked sheets can occur.

#### Inspection Procedure

- 1) Do GP 6.3.6 to access the Functional Tests menu. Do the Feed Element functional test. This will cause the eWire to feed one length of wire and move it into the stack position.

#### Service Settings Menu → Function Tests → Feed Element

- 2) Locate the Element Height Setup tool on the Book Drawer door. Open the Cover, lift up the Vacuum Stacker and place the tool on the element tips. Hold it horizontal against the tines on the Deflector.



- 3) Note the location of the Deflector tines relative to the tool. The top edge of the tool should be lined up with the bottom of the upper chamfer of the Deflector tine. A flashlight is useful for this step. Refer to the following pictures.

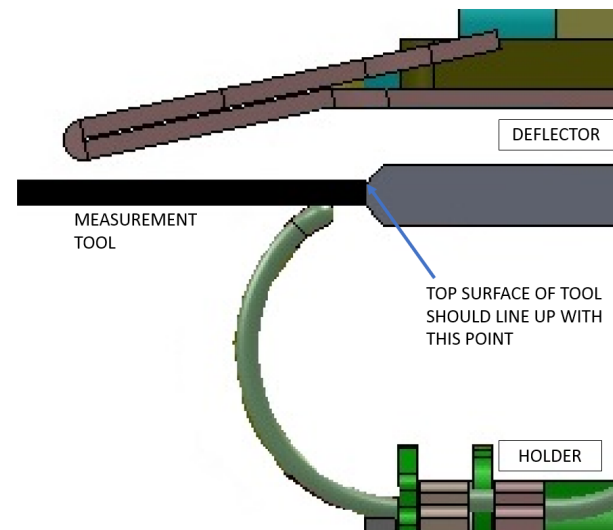
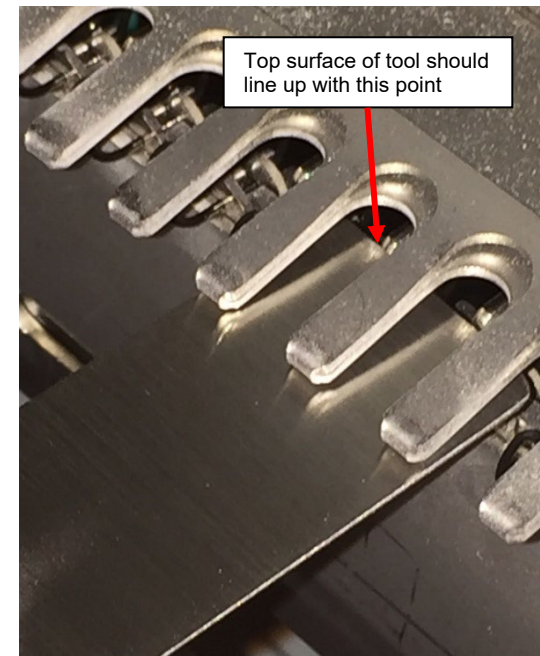

## Adjustment Procedure

- 1) Do GP 6.1.3 to enter the Service Menu. Select Element at Stack Position, which can be incremented from -50 to +50. Increasing this value will raise the element tips and decreasing it will lower the element tips.

### Service Settings Menu → Element

- 2) Raise or lower the Element at Stack value by 5.
- 3) Insert a cheater into the Lid Interlock
- 4) When motion stops remove the element from the holder
- 5) Repeat the Inspection Procedure
- 6) When the Element wire tip position is correct, return to the procedure that directed you here. **NOTE: THIS PROCEDURE ONLY EFFECTS THE ELEMENT SIZE CURRENTLY LOADED AND MAY HAVE TO BE REPEATED FOR OTHER SIZES.**

## ADJ 1.11 Closer Cam Phase Adjustment

Use the following procedure to correct the phase of the cams in the closer when binding closes unevenly.

### Adjustment Procedure

- 1) Remove the Front Closer Cover and the Top Closer Cover by removing the M4 screws (3).

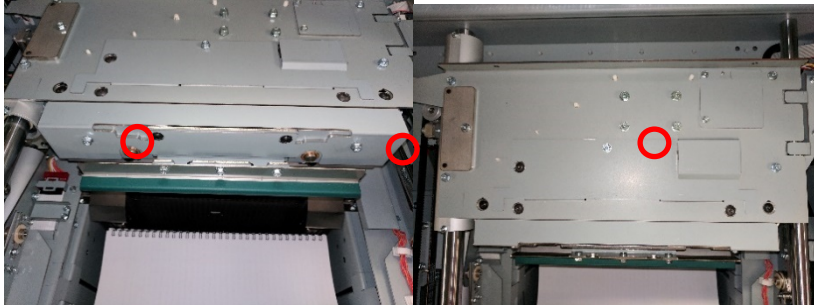

- 2) Cheat the Top Cover Interlock.
- 3) Do GP 6.3.4 and perform the Feed Element and the Full Close Function Test. Inspect the rear side of the element to determine if it is under or over closed.

**Service Settings Menu → Function Tests → Feed Element → Full Close**

- 4) Do GP 6.3.4 and perform the Closer ADJ Pos Function Test. This will allow access to the M5 Screw in the Clamping Collar shown below:

**Service Settings Menu → Function Tests → Closer Cycle**



- 5) Loosen the M5 Screw in the Clamping Collar, do not remove it fully.
- 6) Leave the hex key in the Clamping Collar Screw and hold it in position. Using a 7mm wrench, on the flat of the shaft, rotate the shaft in the direction needed to correct the uneven binding. If the closer shaft does not have flats, the adjustment must be made by pushing on the rear cam in the required direction.

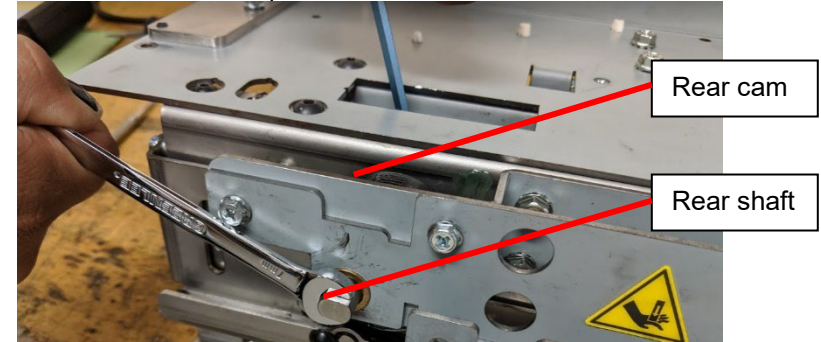

- 7) When looking at the front of the Closer Module, rotate the rear shaft (or cam) counter-clockwise if the rear side of the element is over closed and clockwise if it is under closed. Take note that a small adjustment will have a large impact on the closing of the rear side of an element.
- 8) With a hex key inserted, push the hex key toward the rear of the machine while tightening the M5 Screw to a torque of 6Nm. Note: If a torque wrench is unavailable, use the leverage of a nut driver to achieve the proper torque.

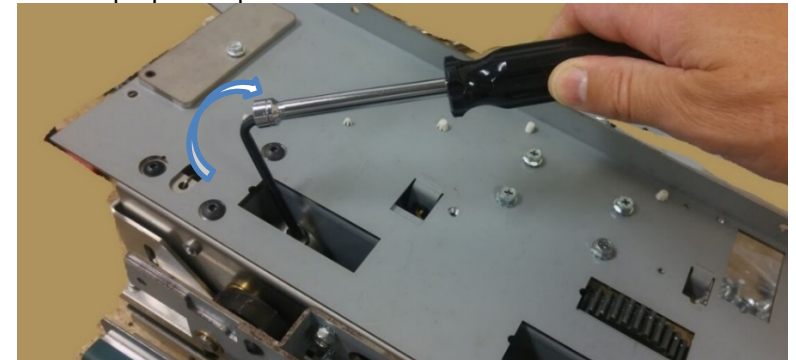

- 9) Cycle the Top Cover Interlock. Note: Take care to remove the hex key before cycling the interlock.
- 10) Repeat steps 3 – 7 until the rear of the element is closed to the same amount as the front.
- 11) Reinstall the Top Closer Cover and the Front Closer Cover with the M4 Screws (3).
- 12) Return to the procedure that directed you here.

## ADJ 1.12 Caster Height Adjustment

Use the following procedure to adjust the height of the eWire.

### Adjustment Procedure

- 1) Perform REP 1.5 to remove the Back Cover to gain access to the rear casters.
- 2) The front casters can be accessed by opening the Element Feeder and the Book Drawer doors. To reach the caster you must pull out the drawer completely and access the caster behind it. Do not pull out both drawers at the same time, this will block access to both casters.
- 3) Ensure that the paper path exit guide on the upstream device is level horizontally with the entrance guide of the eWire. The paper path center line of the upstream exit guide should be vertically aligned with the center of the eWire entrance. Adjust the casters of eWire as necessary to achieve this. A piece of thick paper (200gsm or heavier) can be fed through the upstream device into the eWire for a better visual of the height alignment.

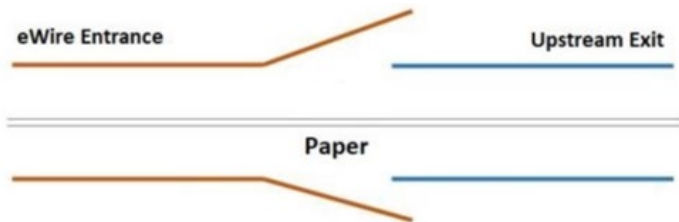

- 4) Loosen the M12 Jam Nut on the caster or casters that require adjustment. Do not remove the Jam Nut completely.

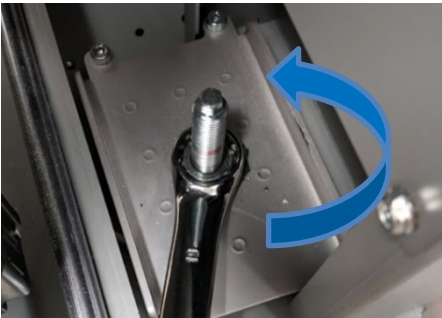

- 5) To adjust the height of the caster, use a 7mm wrench. To raise the eWire, rotate the caster nut clockwise. To lower the eWire, rotate the caster nut counter clockwise.

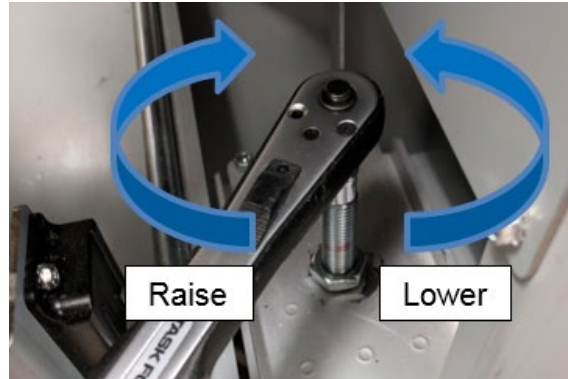

- 6) After making the required adjustments, check that the top cover of the eWire is level in the paper path direction and the downstream end of the eWire matches the level of the upstream end front to back (inboard/outboard). If it is not level, readjust the casters.



- 7) After the eWire is at the desired height and level, tighten the jam nuts to lock the height.

### ADJ 1.13 Partial Close Adjustment

In order to remove the cut wire from the Holder module, the Closer will clamp down on the wire prior to moving away from the Holder. The amount of travel for this motion is called the Partial Close.

If the partial close value is set too high, the Closer will get stuck when moving away from the Holder. This will occur primarily when the book thickness is close to the max thickness for a given size.

If the partial close value is set too low, the book may fall out of the Closer during transfer. Poor roundness on only one size element could also be a symptom of partial close too low.

#### Inspection Procedure

- 1) Access the Service Menu and select **Function Tests → Element Cycle → Feed Element → Partial Close**.
- 2) Open the top cover. The closer jaws should have a cut wire held inside the jaws and partially clamped.
- 3) Using a hook, Allen wrench, or similar tool, attempt to pull the wire out of the Closer jaws. If the element slips out freely with minimal force, the Partial Close is set too low. Repeat this test on the front and rear.
- 4) If the element is securely held, try running a book with max sheet thickness. Verify if a bind jam occurs. If a bind jam occurs, the partial close is likely set too high.
- 5) If the clamping force seems different on the front and rear, verify that the closing is even across the element. Refer to ADJ 1.11

#### Adjustment Procedure

- 1) Access the Service Menu and select PARTIAL CLOSE
- 2) Increase or decrease the Partial Close value based on your findings from the Inspection Procedure.
- 3) Repeat the steps in the Inspection procedure to verify if the new value is correct.
- 4) If partial close seems correct, run several books to determine if the problem is resolved. If not, return to the section that directed you here.

### ADJ 1.14 Element Xfer Position Adjustment

The element transfer position controls the position of the wire while it is being transferred from the Element Feeder to the Holder. Changing this value will adjust the amount of travel for the element feed belt prior to transferring the wire.

- 1) If the element transfer position is off, the most likely result is difficulty with successfully picking up the wire and placing it onto the Holder.
- 2) Check for consistent issues with wire falling off the Holder. The wire could be completely off the Holder and loose inside the machine. It could also be poorly held on the Holder and partially fall off during operation.



- 3) If these issues are seen, changing the Element Xfer Position may help.
- 4) Always note the initial setting so you can return to this value if needed.

#### Adjustment Procedure

- 1) Use an interlock cheat in the interlock of the top cover so that the top cover can be left open.
- 2) With a spool in the machine perform the element transfer function test  
**Service Menu → Function Tests → Transfer**
- 3) An element will feed, cut and transfer towards the holder but stop before the element is placed on the holder.



- 4) The LCD will now show “JOG POSITION”. The expanding T can now be moved using the up and down arrow keys to move the element closer to the holder. Move the element closer to the holder so that it is close to the holder grooves. View the element at the holder grooves as indicated by the arrow in the image below. The deflector can be removed per REP 5.1 to make viewing the element on the holder easier. The holder solenoids will keep open for 2 minutes and then turn off to prevent overheating.

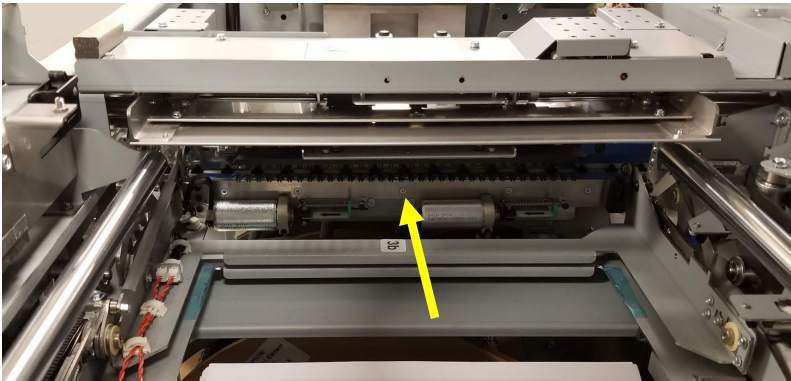

- 8) Reset the machine so that it is ready to prepare another element.
- 9) Repeat steps 1- 4 and check if the element is now aligned to the holder grooves.
- 10) Repeat steps 5 – 9 until the element is aligned to the holder.
- 11) Run a number of books to verify the adjustment made has solved the problem.
- 12) If no improvement is seen by changing the ELEMENT XFER POS value return to the RTP that directed you here.

- 5) Make a note of the direction the element will need to move to be aligned with the holder grooves and the distance.

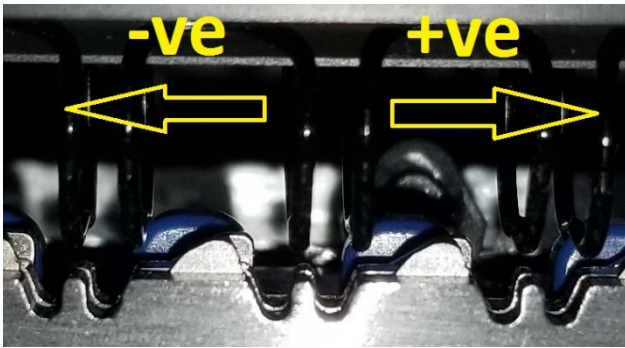

- 6) Access the Service Menu and select ELEMENT XFER POS  
**Service Menu →Elem Xfer Pos.**

- 7) Change the value in the direction indicated in step 5. by 15 counts per mm of offset previously measured. i.e. If the offset is -1mm then reduce the ELEMENT XFER OFFSET by 15.

### ADJ 1.15 Element Feeder Horizontal Position Adjustment

The Element Feeder horizontal position is controlled by a pin and plate at the back on top of the drawer. Set this to ensure the holder pins are aligned with the element feeder location holes.

#### Inspection Procedure

- 1) Close the top cover or use an interlock cheat to home the machine.
- 2) Access the Service Menu and select Holder to Xfer.

#### Service Menu → Function Tests → Holder to Xfer

- 3) Open the top cover or remove the interlock cheat and manually pull the holder out from the feeder so that the pins are close to but not engaged with the element feeder holes.
- 4) Manually push the holder forward so that the pins slowly engage with the element feeder holes and watch for any horizontal shift. Repeat a few times in case needed to observe any shift.
- 5) If there is noticeable shift proceed to adjustment.

#### Adjustment Procedure

- 1) Ensure the holder is back in its home position.
- 2) Open the element feeder drawer so that the pin bracket is exposed, next to the stacking tray, and loosen the 2 screws that hold the pin plate to the feeder drawer.



- 3) Remove the rear cover per REP 1.5.



- 4) Loosen the 2 screws on the latch bracket at the back of the drawer and pull it to the back of the machine.
- 5) Slide the element feeder drawer in. As the plate and the latch bracket are loose it will not stop in a firm location. Ensure the holder is in the home position before sliding the drawer in.
- 6) Manually push the holder forward so that the pins are close to but not engaged with the element feeder holes.



- 7) Align the element feeder drawer so the holder can be pushed forward and the pins engage in the feeder holes.
- 8) Move the holder in and out of the feeder just enough to check that the holder pins do not shift when being inserted in the feeder holes. Adjust the horizontal position of the feeder by hand until the holder pins do not shift to engage the holes.
- 9) Once there is no noticeable shift, when the holder is pushed forward, leave the pins engaged in the feeder.

- 10) At the back of the machine push the pin plate up against the plate and tighten the outer screw.

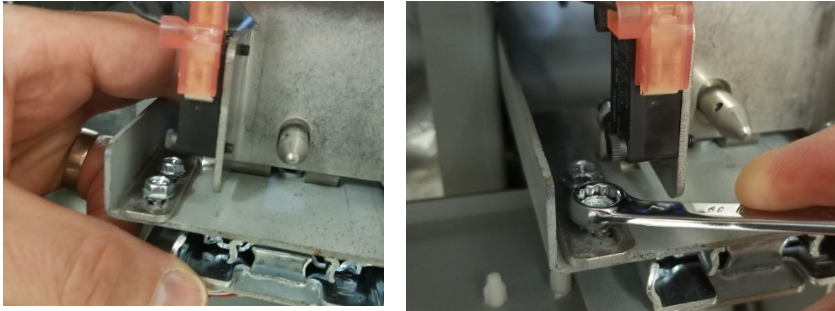

- 11) Tighten the other screw. This is easier to access with the drawer pulled out. Remember the holder will need to be homed before the drawer can be pulled out.
- 12) Push the drawer back in and push the latch bracket forward so it engages on the drawer mounted bracket.
- 13) Tighten the latch bracket screws.

## ADJ 1.16 Element Feeder Angle Adjustment

For proper operation, the element holder module should mate to the element feeder without gaps.

### Inspection Procedure

- 1) Close the top cover or use an interlock cheat to home the machine.
- 2) Access holder to transfer in the service menu

### Service Menu → Function Tests → Holder to Xfer

- 3) Check the gap between the holder face and the feeder.

Gap showing

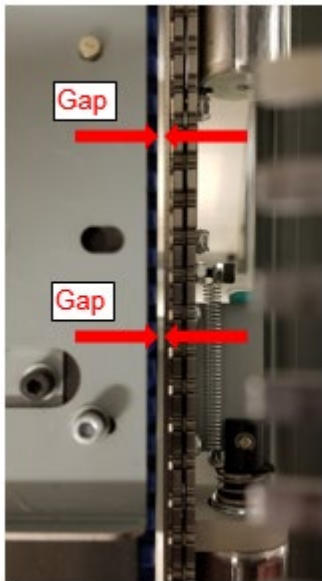

Uneven gap with contact

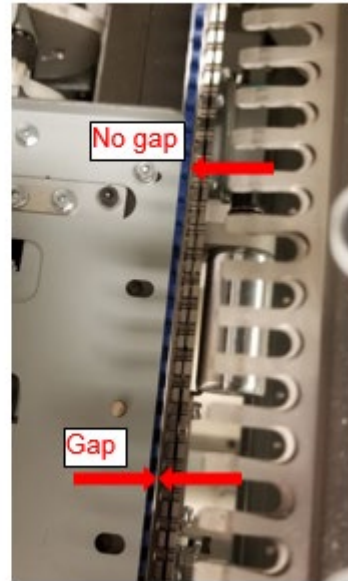

- 4) If the faces are not parallel and have a gap between them or there is a gap at the front or rear then adjustment is required.

### Adjustment Procedure

- 1) If the mating faces are not touching access the HOLDER menu as detailed in GP 6.3.17. If there is uneven contact between the faces go to step 8).

### Service Menu → Holder

- 2) Increase the HOLDER TO XFER value by 5.

- 3) Close the top cover or use an interlock cheat to home the machine.
- 4) Access the Service Menu and select Function Tests → Holder to Xfer.
- 5) Check the gap between the holder face and the feeder.
- 6) Repeat steps 2 through 5 until the mating faces are touching. If the faces are touching across the whole length the adjustment is complete. If not go to step 8).
- 7) If this procedure does not seem to reduce the gap then the holder could be bouncing off the feeder at contact. Try reducing the value to its minimum value (-100) and increasing from there.
- 8) If the faces are not touching across the complete length then the feeder drawer angle can be adjusted.
- 9) Close the top cover or use an interlock cheat to home the machine.
- 10) Open the element feeder drawer and loosen the location pin at the back enough so the pin can slide freely in the slot.



- 11) Loosen the 2 screws on the upper rail from underneath and the 4 screws on the lower rail. The middle slide rail may need to be moved by hand to access all 4 screws on the lower rail.



- 12) Slide the feeder drawer back in.

- 13) Perform function test Holder to Xfer GP 6.3.4 to mate the holder to the element feeder.
- 14) With the element feeder door open hold the drawer handle and push the feeder side to side until the face of the feeder and the holder are parallel and touching across the complete length.
- 15) Pull the holder away from the feeder manually or by homing the machine.



- 16) Carefully pull the element feeder drawer open and tighten the 6 rail screws being careful to maintain the drawer position.
- 17) Tighten the alignment pin being careful not to lose its position. If the pin moves close and open the drawer to realign the pin. The rear cover can be removed (REP 1.5.) and the pin tightened from the rear of the machine if necessary.



- 18) Follow steps 12) & 13) to check the mating. Follow steps 9) through 18) again if the holder face is not fully mated to the feeder.

## ADJ 1.17 Element Feed Belt Tension Adjustment

Maintaining proper tension on the Feed Belt is critical to proper feeding of an element. If the belt is too loose, the element loops will not mesh properly with the belt teeth, the belt will slip, and/or the end of the element will not be seated properly on the teeth and transfer to the holder incorrectly.

### Inspection Procedure.

- 1) Check the belt tension by placing a ruler as shown and pushing the belt upward. The deflection of the belt should be less than 12mm.

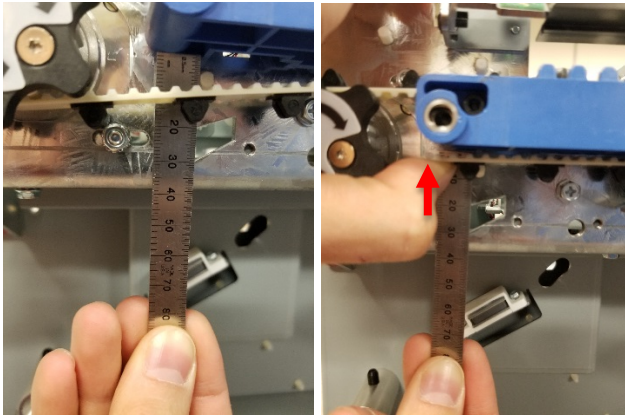

### Adjustment Procedure

- 1) Remove the Upper Element Feeder Cover by removing the M4 Screws (2).

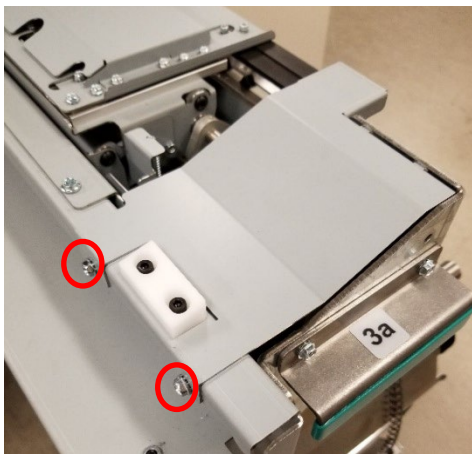

- 2) Loosen the M4 Screws (4) holding the M10 motor.

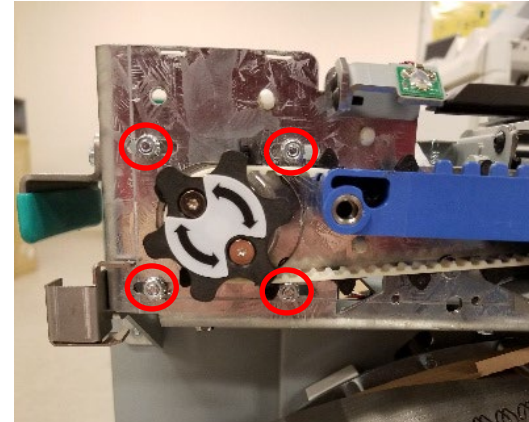

- 3) Pull the body of the motor in the direction shown and tighten the M4 screws (4X) while maintaining pressure.

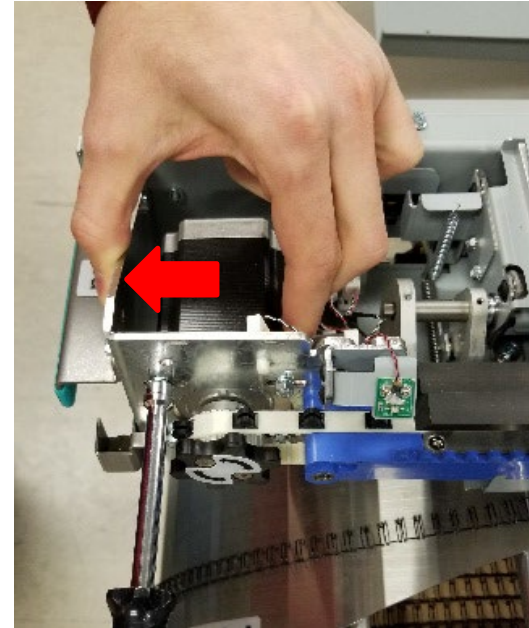

- 4) Verify the belt tension as indicated in the **Inspection Procedure**.
- 5) Reinstall the Upper Element Feeder Cover.

## ADJ 1.18 Knife Blade Adjustment

This adjustment will ensure the Knife blade is aligned to the cutting surface. If the alignment is poor, the Knife may fail to cut the wire.

Perform this adjustment every time the Knife blade is replaced. This adjustment can also be done if there is poor or inconsistent cutting of the wire.

### Adjustment Procedure

- 1) Open the Element Feed Drawer and remove the Knife Cover.
- 2) Loosen the two screws securing the Knife Blade. Use a 7mm wrench and 3 mm Allen key. Loosen the knife until the blade is able to move freely, but do not completely remove the screws.
- 3) Close the Element Feed Drawer and cycle the knife. Watch and listen to the knife as it cycles. When the Knife is in its down position, pull the interlock cheat key or open a cover to stop the motion.

### Service Menu → Function Tests → Knife Cycle

- 4) Open the Element Feed Drawer and verify that the Knife blade is fully pressed against the cutting block. Using a flashlight, check to make sure no light can be seen between the knife and anvil in the cutting area. Light can be visible below this area by the mounting screws.

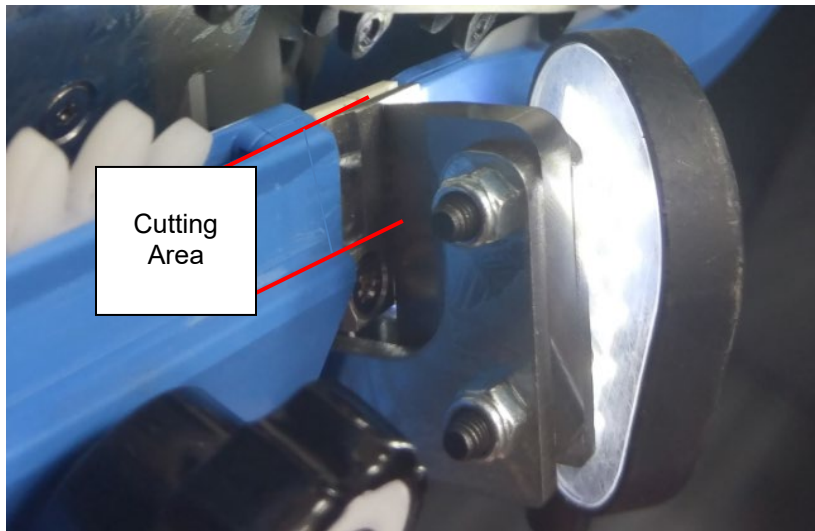

- 5) Re-tighten the screws securing the Knife Blade.



- 6) Close the Element Feed Drawer and home the eWire.
- 7) Run the Feed Element command several times using A size wire (or the smallest wire you have available) to ensure that the wire is cut cleanly each time.

### Service Menu → Function Tests → Feed Element

## ADJ 1.19 Top Cover Latch Adjustment

Adjust the top cover latch to ensure the gap between the upper and lower transport is set correctly. If the gap is too large, rollers may not have the appropriate nip force.

### Inspection Procedure

- 1) You can verify if the gap between the upper and lower bypass is too large by pressing down on the top cover. If the top cover moves significantly when you press on it, the gap is likely too large.
- 2) You can also verify if the top cover adjustment is off by pressing down on the top cover during operation. If jams no longer occur while pressing on the top cover, the latch likely needs to be adjusted.

### Adjustment Procedure

- 1) Remove the top cover by following the REP 1.1 for Top Cover Removal.
- 2) Locate the 4 Screw securing the latch assembly and loosen the screws. This will allow the latch and cover to move freely.

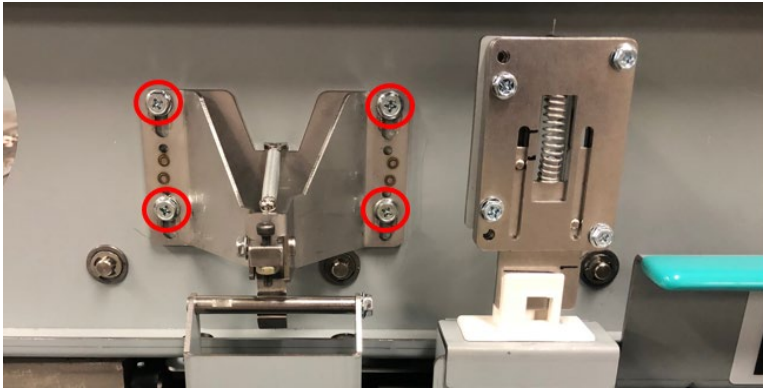

- 3) Press down on the top of the frame until the upper and lower bypass panels are in contact.

- 4) Without letting go of the frame, lift the Latch Assembly until the hook of the latch is in contact with the latch pin. Tighten the 4 screws to secure the latch in this position. This may require 2 people, or you can use a weight to press down on the top of the assembly.

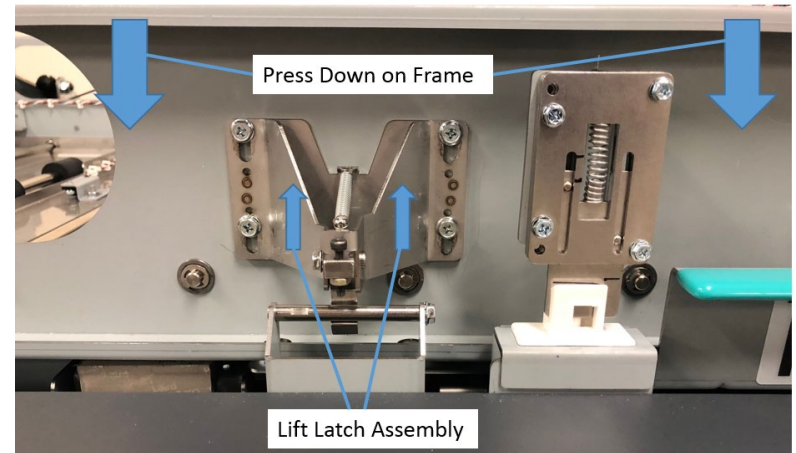

- 5) After adjusting it, repeat the steps in the Inspection Procedure to ensure that the latch is set correctly. If necessary, repeat steps 2 thru 4.
- 6) Replace the Top Cover and resume operation.



## ADJ 1.20 Cover Interlock Flag Adjustment

This adjustment will set the spring loaded interlock flag at the correct location and ensure the machine operates correctly while the cover is closed and opens once the cover latch is disengaged.

### Adjustment Procedure

- 1) Follow REP 1.1 to remove the top cover.
- 2) Carefully close and latch the Upper Paper Transport.
- 3) Loosen but do not remove the M4 fasteners (2) securing the Interlock Flag Assembly
- 4) Gently push down on the interlock flag assembly until the spring loaded flag contacts the sides of the interlock. Reference the scribe line on the flag for correct interlock setting. Example can be seen below.
- 5) Tighten the M4 fasteners (2) securing the Interlock Flag Assembly.
- 6) Follow REP 1.1 to reinstall the top cover.
- 7) Test the interlock is functioning properly. Close cover and the machine should show "Ready" or "Bypass". Press latch release and the cover should lift slightly. Ensure display shows "Close Cover" when the cover lifts slightly.

## ADJ 1.21 Element Shield Adjustment

If the element shield requires adjustment it can bend down towards the ground and contact the supply spool. This will increase the force require to turn the rewind spool and result in repeated paper tears and J320 Spool Element Slack Timeouts

### Inspection Procedure

- 1) Remove the element feeder shield and check that the 2 studs on the shield are tight. If they are loose, tighten the button head cap screws using a 2.5mm hex key and an 8mm crescent wrench to prevent the studs from rotating.



- 2) Mount the element feeder shield with a spool loaded on the spindle, making sure that the pins are fully seated in the hole and slot, and that the side of the shield is in contact with the magnet.

- 3) Once properly mounted there should be a gap of approximately 10mm between the top of the spool and the last roller on the shield. Below is an example of a good shield position. If your shield does not have a sufficient gap proceed to the adjustment steps.



- 4) Press down firmly on the top of the shield until it contacts the spool as shown below. When you release the pressure, the shield should spring back to the position shown in step 2. If the shield does not spring back proceed to the adjustment steps.



### Adjustment Procedure

- 1) Remove the element feeder shield,
- 2) Locate the magnet on the side of the element feeder drawer.

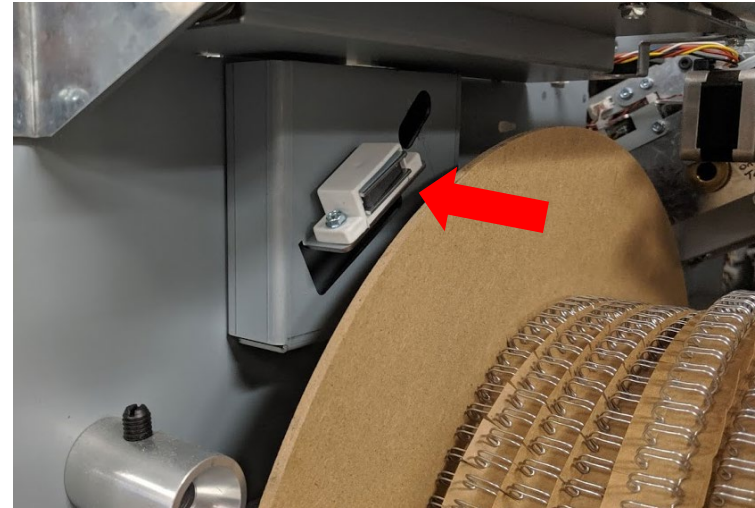

- 3) Loosen the (2) M3 screws securing the magnet using a 5.5mm crescent wrench or a Phillips head screw driver.
- 4) Move the magnet away from the spool, in the direction of the arrow shown in step 2.
- 5) Tighten the (2) M3 screws holding the magnet.
- 6) Repeat the inspection steps at the beginning of this adjustment. Repeat the adjustment until it passes the inspection.

## ADJ 1.22 Closer Full Open Adjustment

An F size spool must be installed in the eWire to perform this adjustment.

The closer full open delay adjustment increases the opening of the closer jaws when in a full open position. The setting is measured in milliseconds and is the amount of time M20 continues to operate after detecting that the top jaw is in the full open position. This setting is only visible in the service menu when an F size spool is loaded in the machine and the setting only effects the closer home position for F size books.

Before performing this adjustment check that the [ADJ 1.11 Closer Cam Phase Adjustment](#) is set correctly and the closer jaws are opening evenly.

- 1) Remove the pusher plate from the closer by removing the (3) M4 screws that secure it



- 2) Open the top cover and place an interlock cheater in the top cover interlock to home the machine.
- 3) Remove the interlock cheater

- 4) The closer full open home position should result in a gap of 26.4mm to 27mm between the top and bottom jaws. If calipers aren't available to measure this, cut 2 cover stock strips 26.4mm and 27mm to use as gauges. The closer jaws should be set so that the 27mm piece does not fit in the jaw while the 26.4mm piece does.

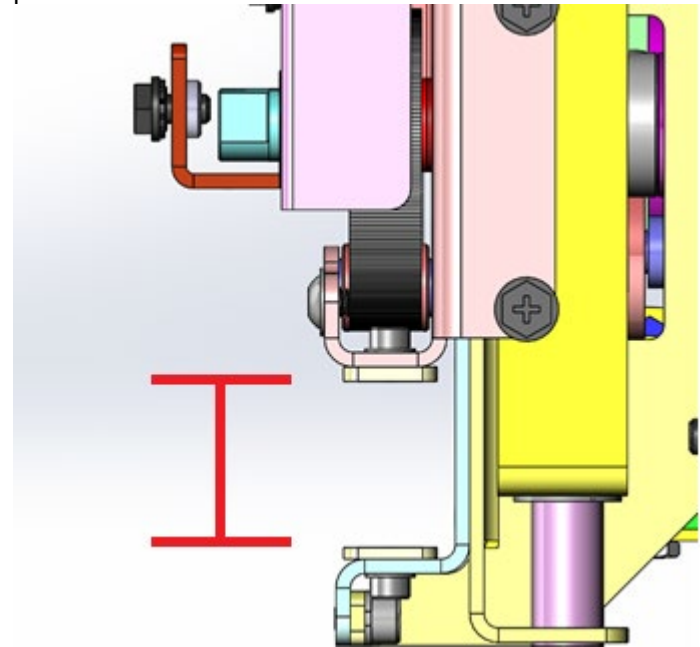

- 5) If the jaw opening measures below 26.4mm, increase the closer full open delay in increments of 1-3 and repeat steps 2-4 until the closer opens the desired amount.  
If the jaw opening measures above 27mm, decrease the closer full open delay in increments of 1-3 and repeat steps 2-4 until the closer opens the desired amount.
  - a. Service Menu → CLSR OPEN DEL
- 6) Reinstall the pusher plate on the closer

### ADJ 1.23 Holder to Closer F Adjustment

An F size spool must be installed in the eWire to perform this adjustment.

This adjustment changes the height the holder holds the element at when the closer comes to receive it. This only effects behavior with an F size element. The ideal position for this adjustment is when the bottom of the element rests lightly on the bottom closer jaw. The holder should not visibly lift when it meets the closer and you should not be able to slide a piece of paper between the bottom closer jaw and the element when the holder and closer are mated.

- 1) Remove the deflector from the eWire to better view the holder and closer. Ensure that the removed cable pins are not touching each other or the frame. Perform REP 5.1 to remove the deflector. Leave this out of the machine until you complete the F Size Partial Close Adjustment
- 2) Open the top cover and place an interlock cheater in the top cover interlock.
- 3) Perform the Feed element function test with the top cover open
  - a. Service Menu →FUNCTION TESTS → ELEMENT CYCLE → FEED ELEMENT → LTR or A4
- 4) After the element feed completes select PARTIAL CLOSE. When the closer begins to move remove the interlock cheater.
  - b. Service Menu →FUNCTION TESTS → ELEMENT CYCLE → PARTIAL CLOSE
- 5) Push the closer toward the holder by hand slowly until the element is about to enter the closer
  - c. Place your left hand on the holder and advance the closer towards the holder until the element enters the closer.
  - d. If you felt the holder being lifted by the closer when they met, HOLDER TO CLOSER F must be reduced.
  - e. If the element entered the closer and did not lift at all, reduce the HOLDER TO CLOSER F value until you feel the closer lightly rub the bottom of the element when performing step 5.
- 6) Repeat steps 3-5 until the element is resting on the lower closer jaw properly.

Below is an example where the element is hitting the closer jaw. When pushing the closer towards the holder, the element hit the lower jaw and the closer could not advance without lifting the holder.

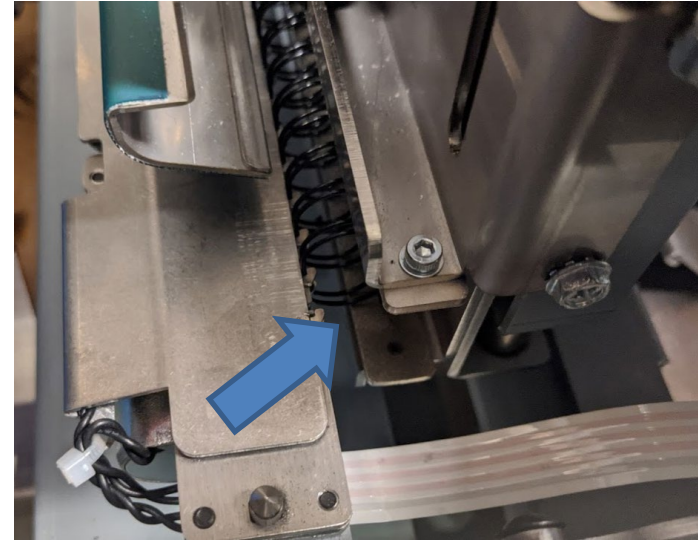

## ADJ 1.24 F Size Max Capacity Closer Adjustment

An F size spool must be installed in the eWire to perform this adjustment.

A 10mm stack of punched body paper (A4 or LTR) is required to perform this set up (100 sheets of 75 gsm or 90 sheets of 80gsm). Punch these using the punch, bypassing the eWire.

This adjustment will have you repeat many of the steps performed in ADJ 1.23 Holder Closer F Adjustment. This is because when a full F size book is on the holder, the pusher plate on the closer causes the book to pivot slightly in the holder. The previous adjustment is performed to get a baseline position for this setting, but it must be adjusted further with a full book to improve closing quality.

- 1) Open the top cover and place an interlock cheater in the top cover interlock.
- 2) Lift the Vacuum Stacker
- 3) Perform the feed element function test with the top cover open
  - a. Service Menu →FUNCTION TESTS → ELEMENT CYCLE → FEED ELEMENT → LTR or A4 based on the paper you have
- 4) After the element feed completes, place the 10mm stack of sheets onto the element and then lower the vacuum stacker

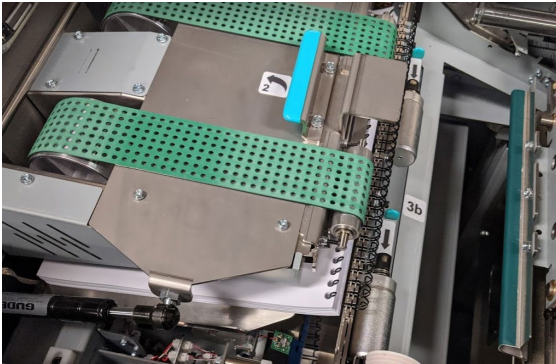

- 5) Select PARTIAL CLOSE. When the closer begins to move remove the interlock cheater.
  - a. Service Menu →FUNCTION TESTS → ELEMENT CYCLE → PARTIAL CLOSE
- 6) Push the closer toward the holder by hand slowly until the element is about to enter the closer.
  - a. Place your left hand on the holder and advance the closer towards the holder until the element enters the closer. Before the element enters the holder, the closer pusher plate will compress the book causing the holder to pivot slightly.

- b. If you felt the holder being lifted by the closer when the element met the closer jaw, HOLDER TO CLOSER F must be reduced.
- c. If the element entered the closer and did not lift at all, reduce the HOLDER TO CLOSER F value until you feel the closer lightly rub the bottom of the element when performing step 5.
- d. If the top of the element hit the top closer jaw, go back to the Closer Full Open Delay Adjustment and increase the delay. You will need to check your partial close once more before returning to this adjustment



- 7) Repeat steps 2-6 until the element enters the closer jaw with minimal shifting
- 8) Perform steps 2-4
- 9) Select PARTIAL CLOSE. Do not remove the interlock, allow the closer to grab the element
  - b. Service Menu →FUNCTION TESTS → ELEMENT CYCLE → PARTIAL CLOSE
- 10) Open the book drawer and look at the closer through the opening it reveals. You may need to pull the closer back to see it. Check to see if the top and bottom tips of the element are touching the back face of the closer. If they are not, double check the adjustments you just performed.



---

---

# 5. Parts List

## Section Contents

Title	Page
PL 5.1 LCD, INTERLOCKS, CASTERS.....	2
PL 5.2 PAPER TRANSPORT - SENSORS.....	3
PL 5.3 PAPER TRANSPORT - MOTORS & SOL.....	4
PL 5.4 PAPER TRANSPORT - REAR SECTION.....	5
PL 5.5 PAPER TRANSPORT - ROLLERS.....	6
PL 5.6 PAPER TRANSPORT - OTHER PARTS.....	7
PL 5.7 ELEMENT FEEDER - SENSORS.....	8
PL 5.8 ELEMENT FEEDER - MOTORS & BELTS.....	9
PL 5.9 ELEMENT FEEDER - TOP SECTION.....	10
PL 5.10 ELEMENT FEEDER - BOTTOM SECTION.....	11
PL 5.11 ELEMENT FEEDER - KNIFE MODULE.....	12
PL 5.12 ELEMENT TRANSFER - SENSORS.....	13
PL 5.13 ELEMENT TRANSFER - COMPONENTS.....	14
PL 5.14 VACUUM STACKER - MOTORS & SOL.....	15
PL 5.15 VACUUM STACKER - MECHANICAL.....	16
PL 5.16 DEFLECTOR MODULE.....	17
PL 5.17 TAPPER MODULE - FRONT.....	18
PL 5.18 TAPPER MODULE - REAR.....	19
PL 5.19 CLOSER MODULE.....	20
PL 5.20 HOLDER - SENSORS.....	21
PL 5.21 HOLDER - MOTORS, BELTS & SPRINGS.....	22
PL 5.22 HOLDER - LOCK & ROTATE ASSEMBLIES.....	23
PL 5.23 BOOK DRAWER - SENSORS.....	24
PL 5.24 BOOK DRAWER - BELTS & PULLEYS.....	25
PL 5.25 FRAME - SWITCHES & LATCHES.....	26
PL 5.26 FRAME - VACUUM & LOCKOUT.....	27
PL 5.27 ELECTRICAL COMPONENTS.....	28
PL 5.28 OUTER COVERS.....	29
PL 5.29 MAIN ASSEMBLY (MODULES).....	30
PL 5.30 TOOLS & KITS.....	31
PL 5.31 CABLES.....	32

PL 5.1 LCD, INTERLOCKS, CASTERS

ITEM	GBC PART #	DESCRIPTION	QTY
1	7715527	LCD Display	1
2	7715641	LCD Membrane Switch	1
3	7706486	Door/Drawer Latches	3
4	7723948	Caster Sub-Assembly	4
5	7724859	Interlock Switch	1

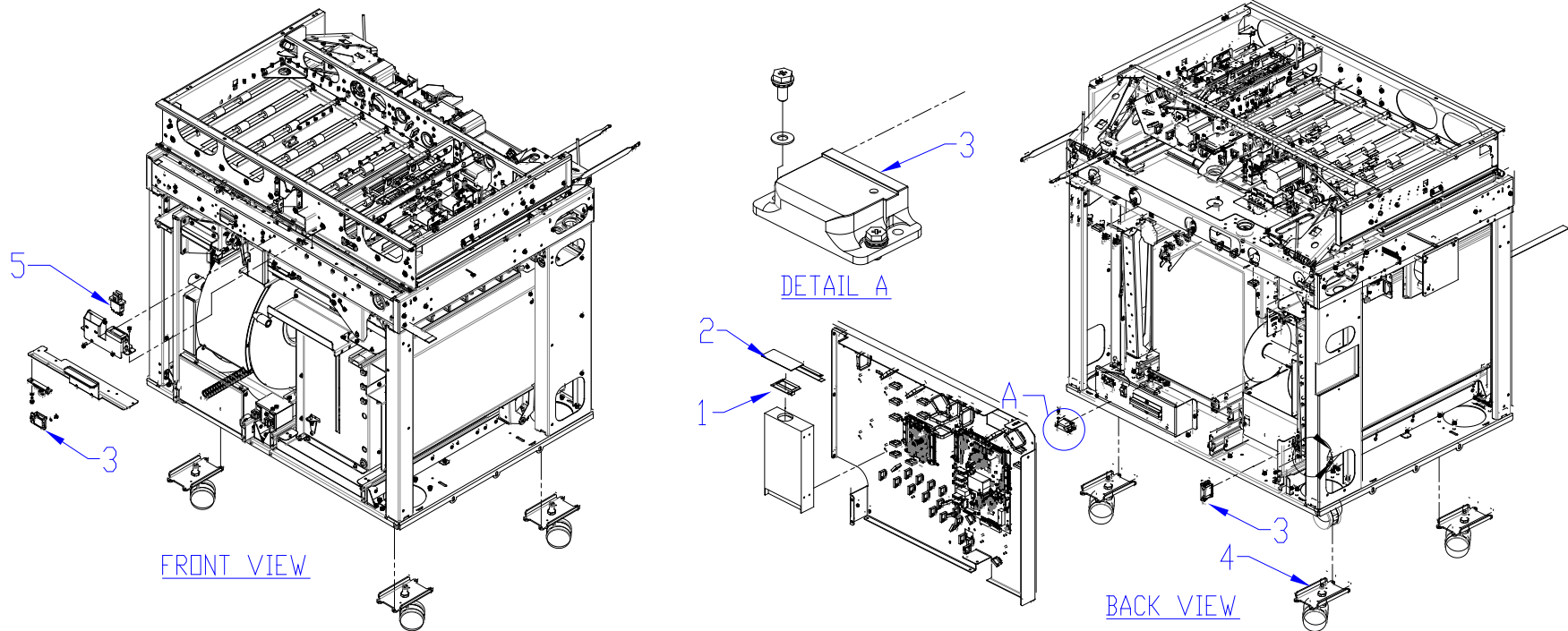

PL 5.2 PAPER TRANSPORT - SENSORS

ITEM	GBC PART #	DESCRIPTION	QTY
1	7715193	Bypass Sensors (S1, S4, S5 & S16)	4
2	7715692	Skew Sensor PCB (S6 - S10)	1
3	7718567	Alignment Sensor PCB Switchable(S12, S13 & S15)	1
4	7715340	Alignment Carriage Home Sensor (S41)	1
5	7723292	Baffle Roller Stepper Motor (M4)	1

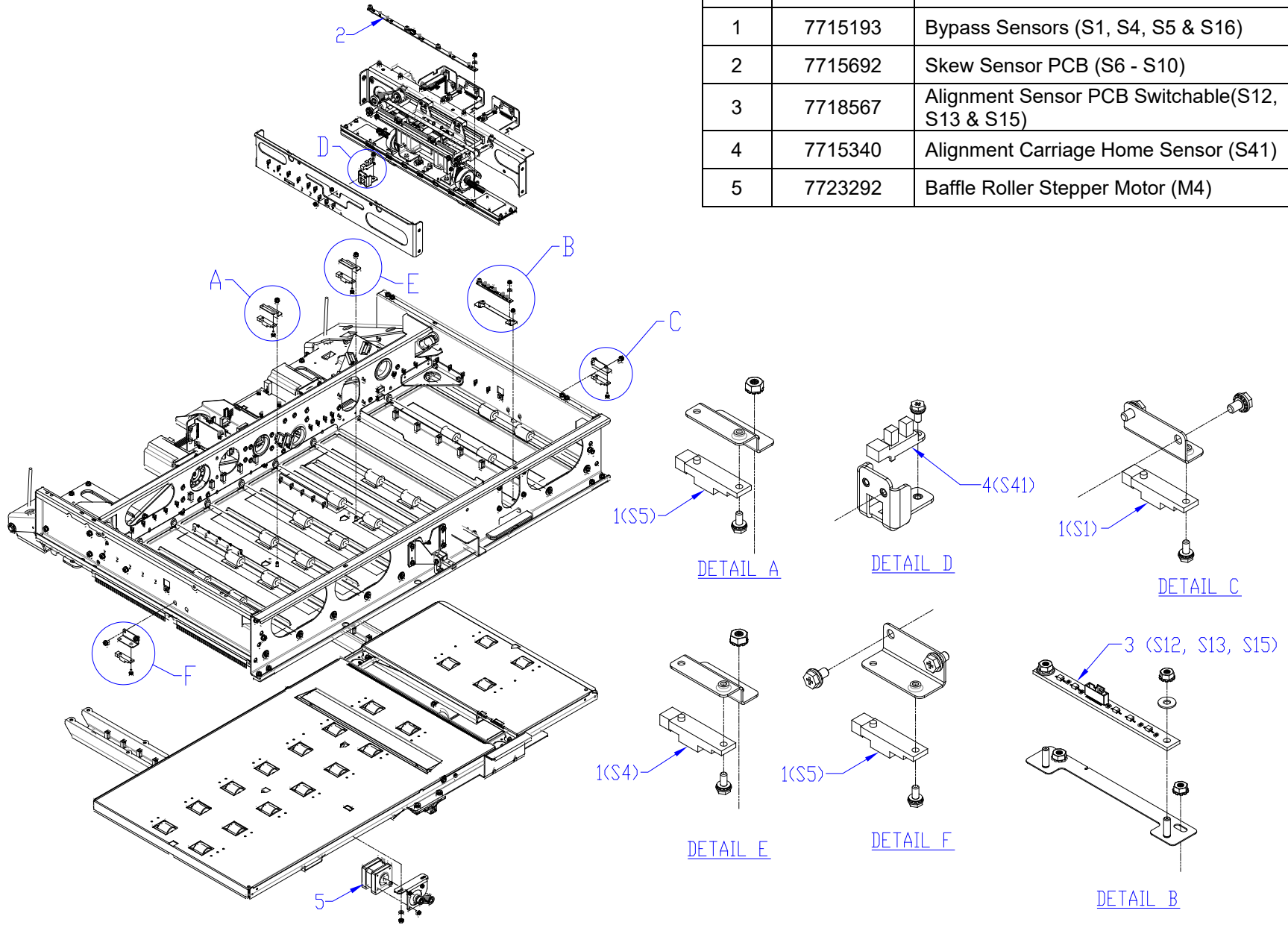



PL 5.3 PAPER TRANSPORT - MOTORS & SOL

ITEM	GBC PART #	DESCRIPTION	QTY
1	7717704	Diverter Solenoid Assembly (L1)	1
2	7717517	Disengaging Roller #1 & 2 (L2 & L3)	2
3	7717520	Disengaging Roller #3 (L4)	1
4	7715200	Bypass Entry and Exit Motors (M1 & M2)	2
5	7715337	Steering Motor #1 & #2 (M16 & M17)	2
6	7715282	Alignment Motor (M18)	1

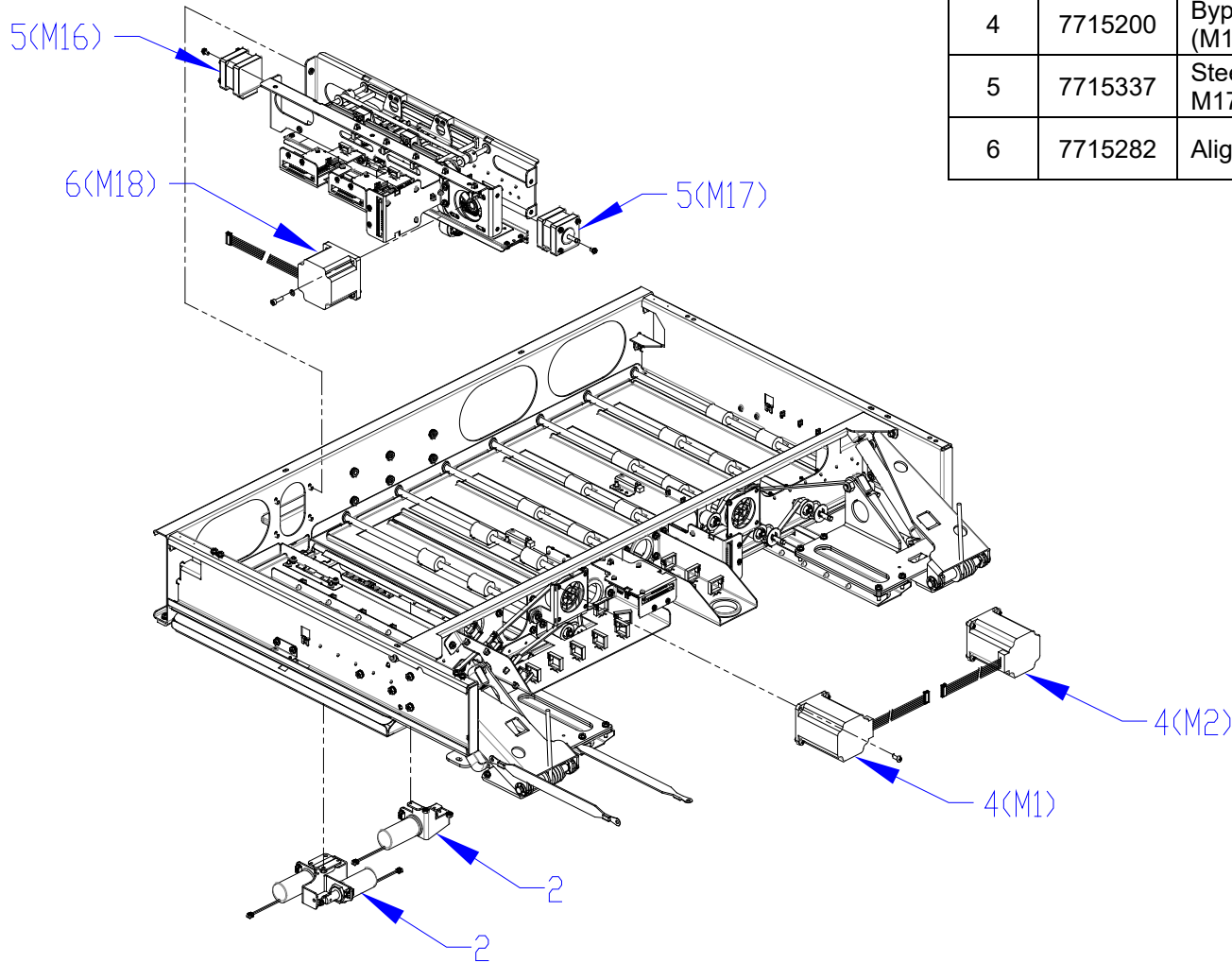

PL 5.4 PAPER TRANSPORT - REAR SECTION

ITEM	GBC PART #	DESCRIPTION	QTY
1	7717561	Bypass Timing Belt #1	1
2	7717562	Bypass Timing Belt #2	1
3	7715204	Drive Roller Timing Pulley	10
4	7715201	Stepper Motor Pulley	2
5	7715383	Drive Roller Idler Pulley	7
6	7715245	Timing Belt Tensioner	2
7	7715275	Stepper Motor Driver Board	2

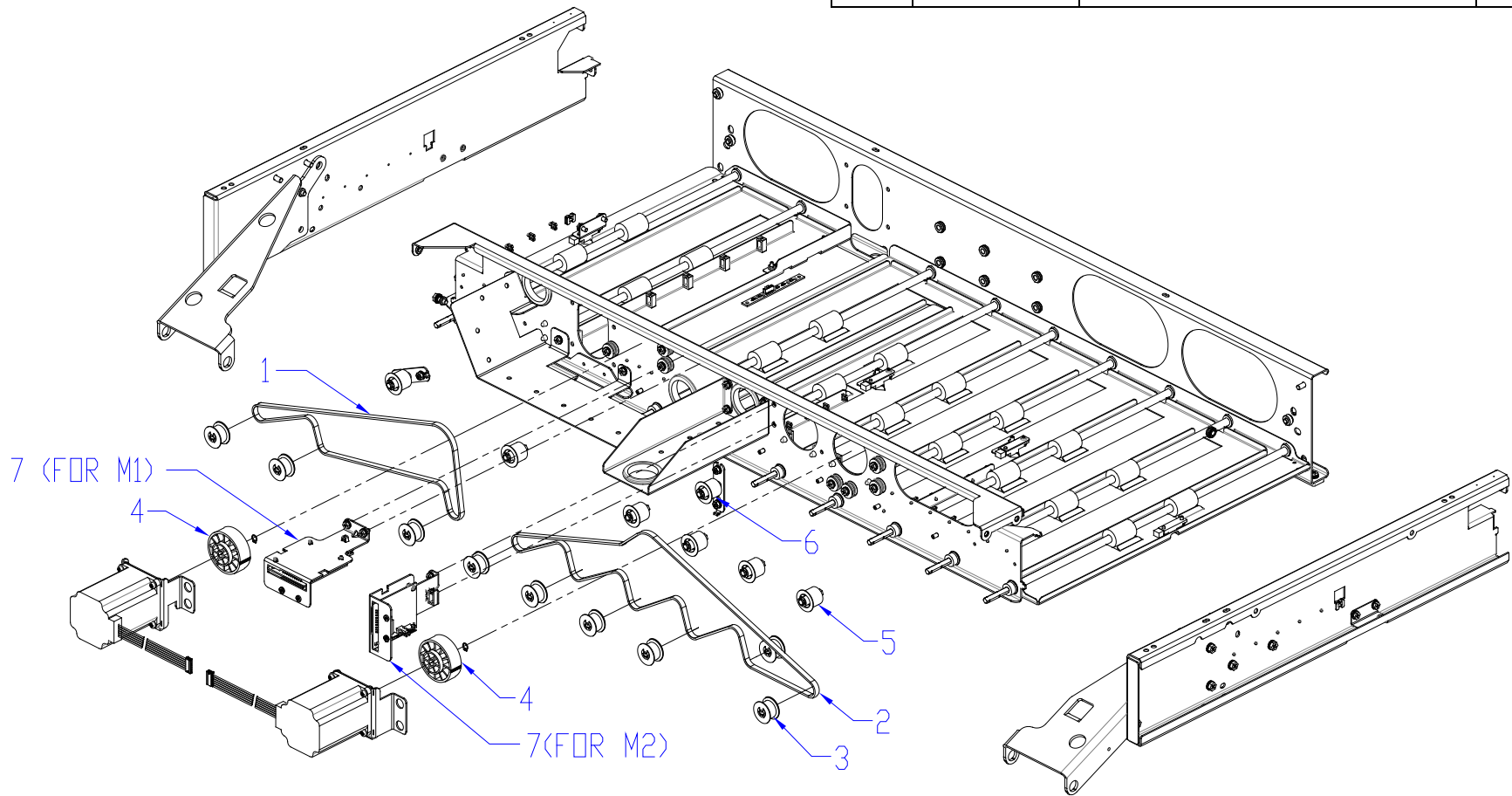

**PL 5.5 PAPER TRANSPORT - ROLLERS**

ITEM	GBC PART #	DESCRIPTION	QTY
1	7723295	Drive Roller Assembly	8
2	1821116	Roller Bearing	18
3	7723432	Steering Drive Roller Assembly	2
4	7718381	Idler Roller Assembly	8
5	7718103	Steering Idler Roller Assembly	1
6	7717802	Delrin Drive Roller Assembly	1
7	7718560	Independent Idler Roller Assembly	1

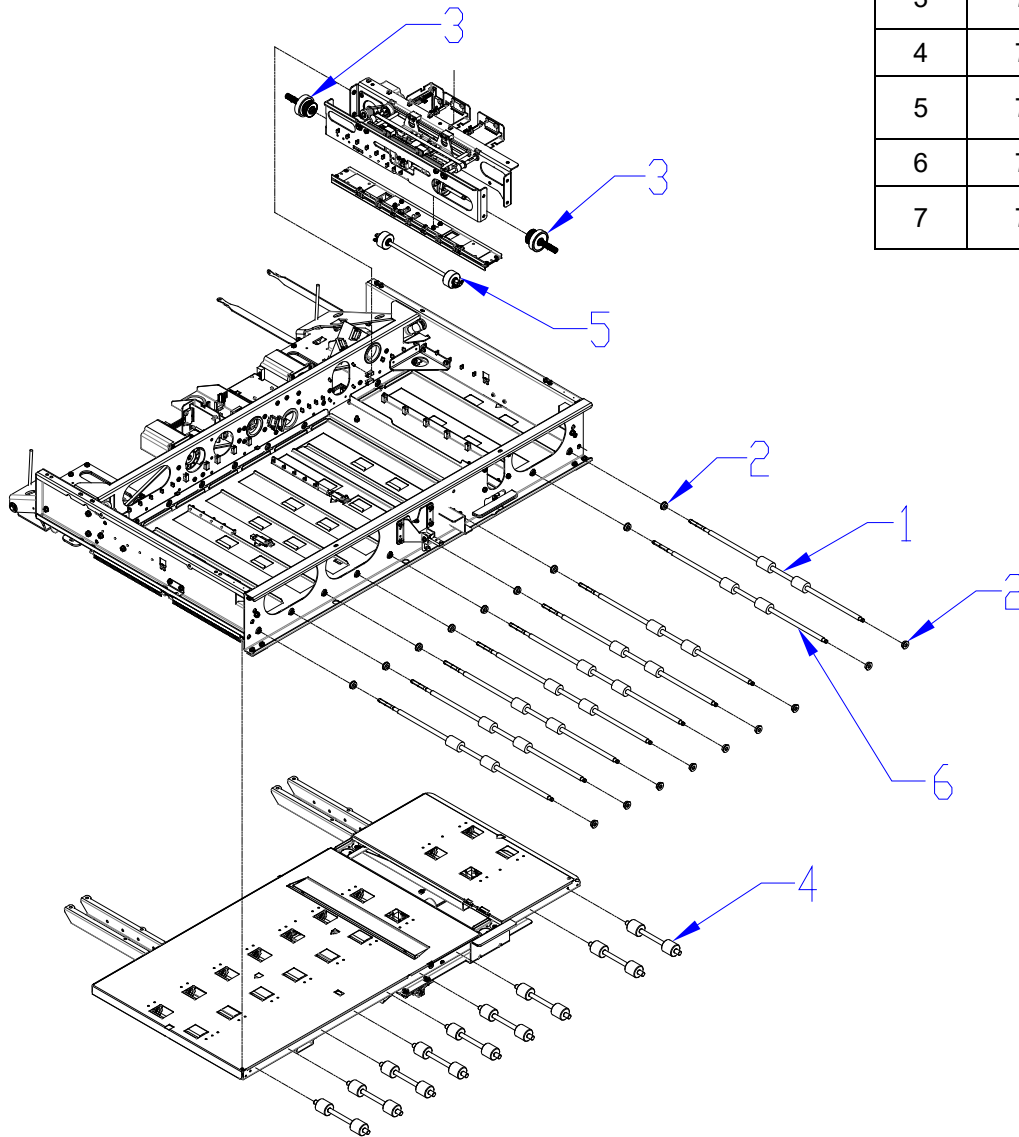

**PL 5.6 PAPER TRANSPORT - OTHER PARTS**

ITEM	GBC PART #	DESCRIPTION	QTY
1	7717393	Steering Module Assembly	1
2	7718593	Anti-Static Brush Long	2
3	7718594	Anti-Static Brush Short	2
4	7718232	Latch Assembly	1
5	7715275	Stepper Motor Driver Board	3
6	7706486	Push to Close Latch	1

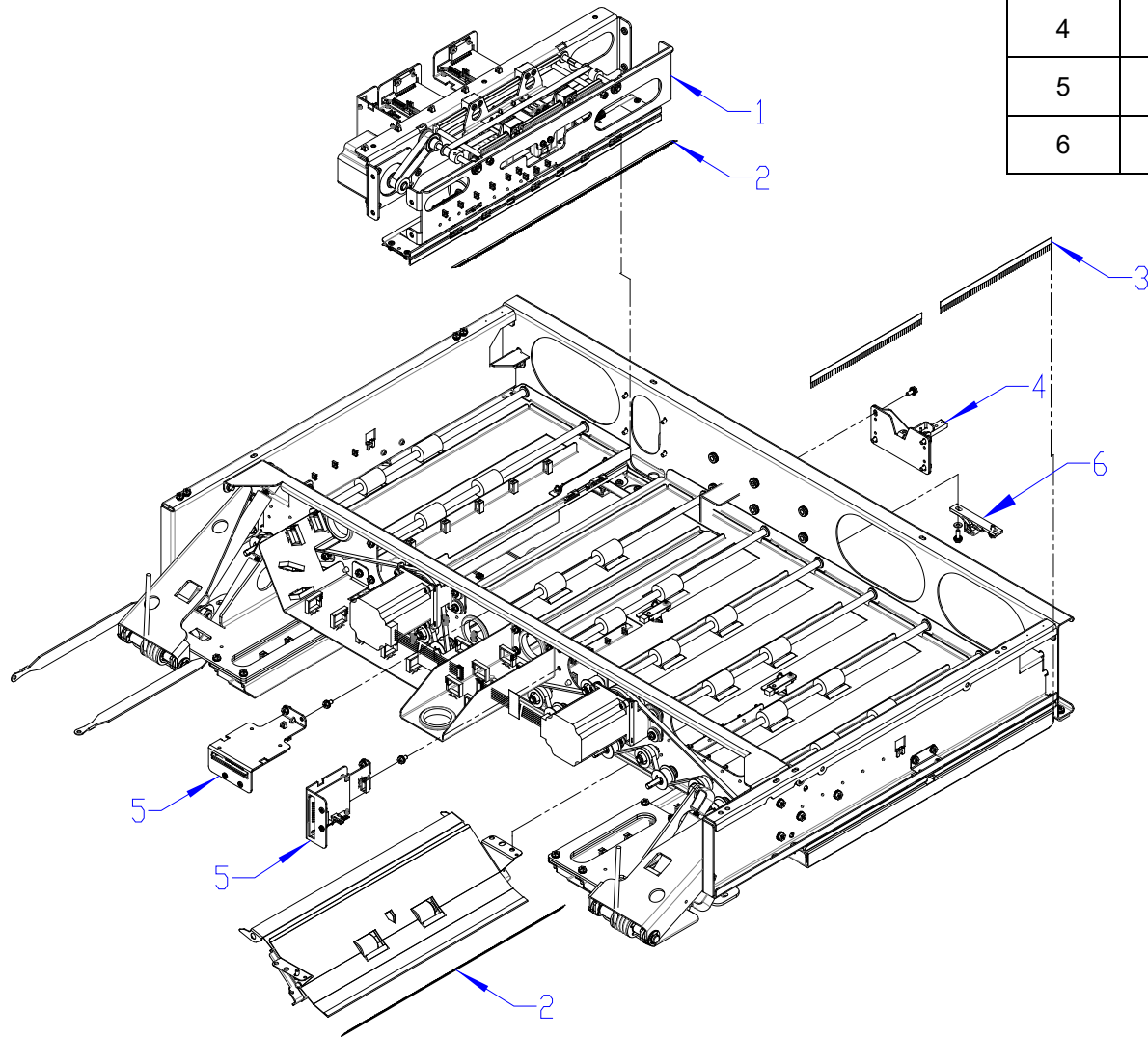

**PL 5.7 ELEMENT FEEDER - SENSORS**

ITEM	GBC PART #	DESCRIPTION	QTY
1*	7723253 & 7716947	Element Detect at Pyramid (S22)	1
2	7723253 & 7716947	Belt Home Sensor Assembly (S25)	1
3	7717206	Spool Detect Sensor PCB (S26-S30)	1
4	7717479	Spool Near Empty Sensor PCB (S50)	1
5	7715340	Element Slack Sensor (S20)	1

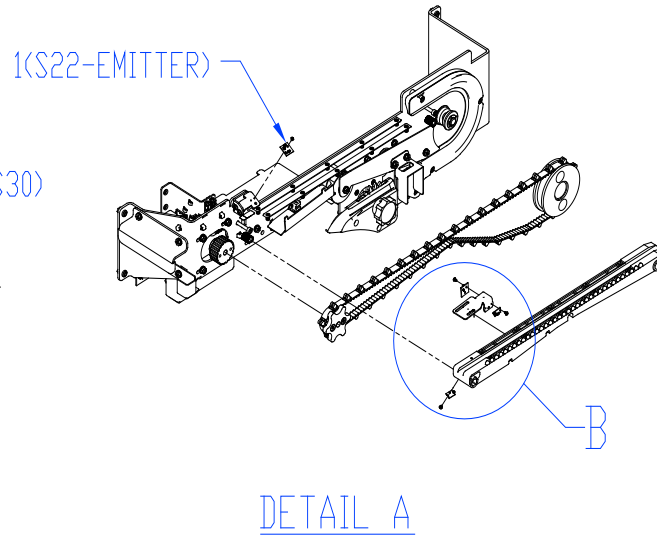
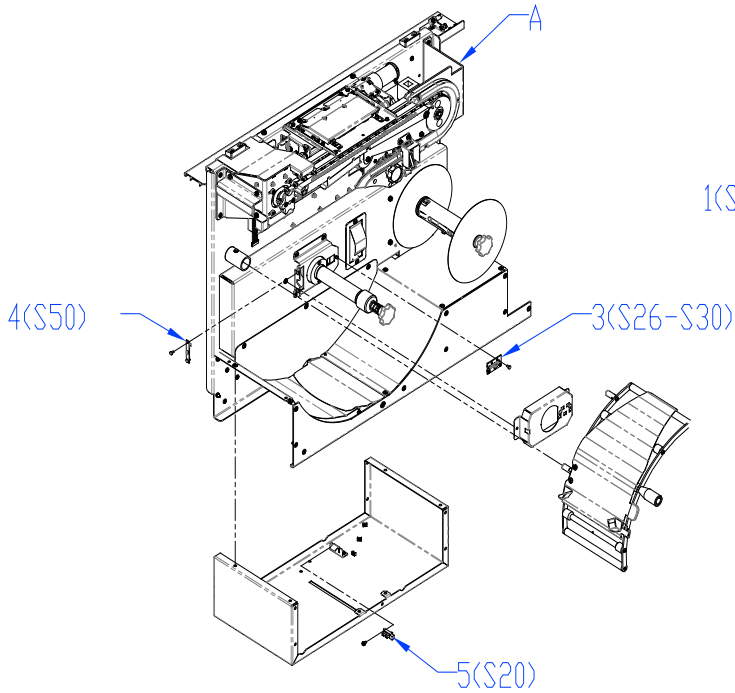

DETAIL A

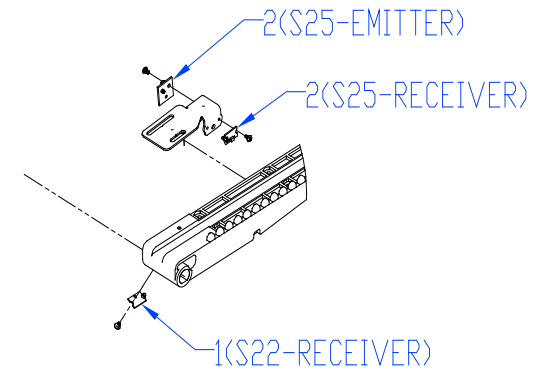

DETAIL B

\*For units with SN DK2003L-DK2005L and EC20001L:  
 Replace 7716961 (PL 5.9) and 7716577 (PL 5.9) when 7723253 (S22) is replaced.  
 Replace 7716961 (PL 5.9), 7716577 (PL 5.9) and 7723253 (PL 5.7) when 7716947 (S22) is replaced.

**PL 5.8 ELEMENT FEEDER - MOTORS & BELTS**

ITEM	GBC PART #	DESCRIPTION	QTY
1	7715200	Element Feed Belt Motor (M10)	1
2	7715337	Element Feed Sprocket Motor (M9)	1
3	7716993	Element Feeder Belt	1
4	7717025	Spool Rewind Belt	1
5	7718107	Spool Rewind Drive Assembly (M8)	1

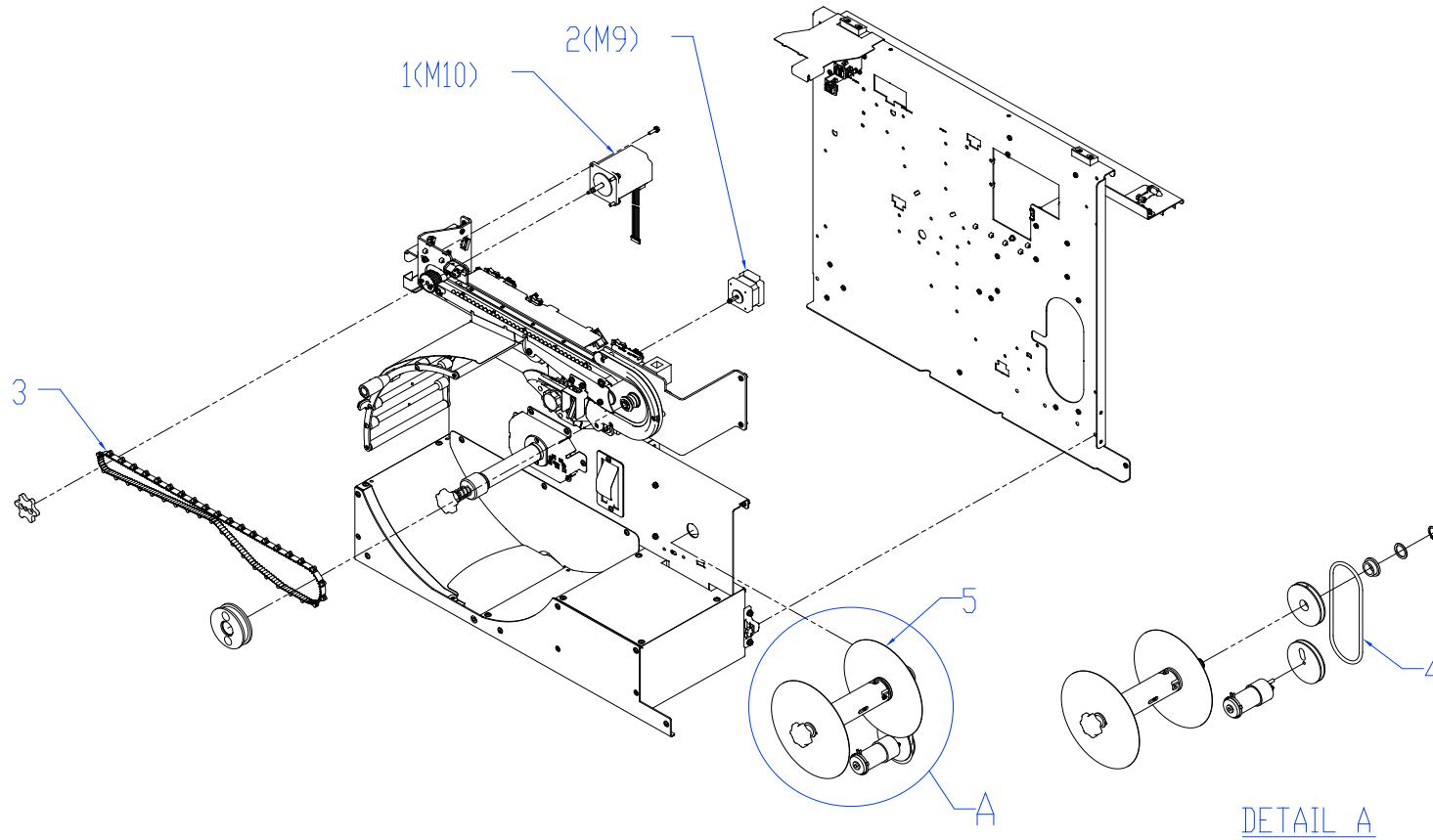

**PL 5.9 ELEMENT FEEDER - TOP SECTION**

ITEM	GBC PART #	DESCRIPTION	QTY
1	7716577	Element Feed Track Assembly	1
2	7718109	Element Feeder Belt Idler	1
3	7718108	Element Engagement Guide Assembly	1
4	7717029	Idler Roller, Element Feeder Belt	2
5	7718110	Element Sprocket Nose Assembly	1
6	7723069	Knife Cover	1
7	7723082	S22 Dust Cover Sticker	1
8	7723209	Alignment Pin Bracket Assembly	1
9	7716961	Element Detect Sensor Bracket (S22)	1

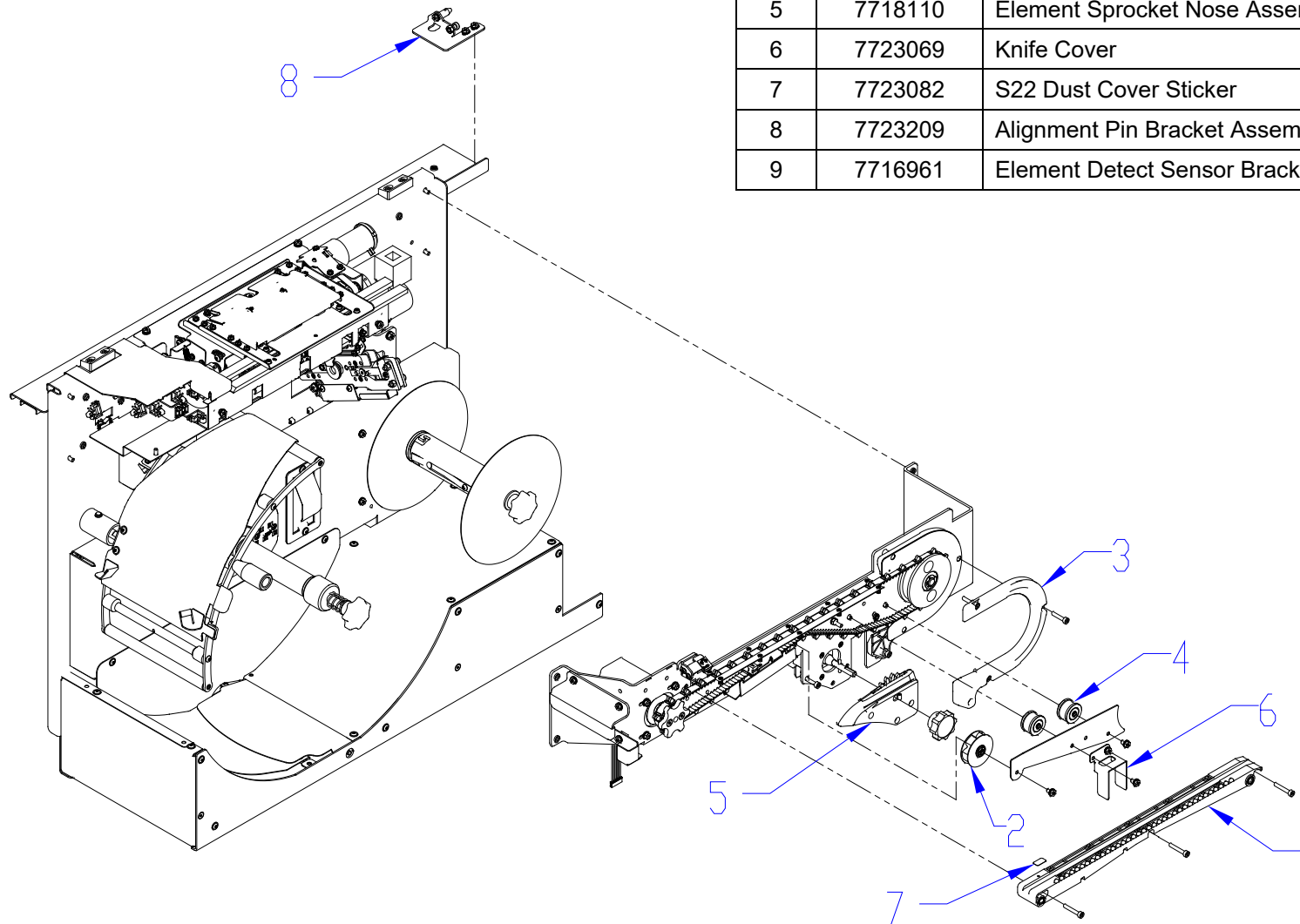

**PL 5.10 ELEMENT FEEDER - BOTTOM SECTION**

ITEM	GBC PART #	DESCRIPTION	QTY
1	7717017	Element Shield Assembly	1
2	7716948	Spool Spindle Assembly	1
3	7717065	Rewind Spindle Assembly	1
4	7723298	Element Slack Detect Lever Assembly	1
5	7717781	Finger, Spool Brake	1
6	7723422	Spool Retainer Knob	1

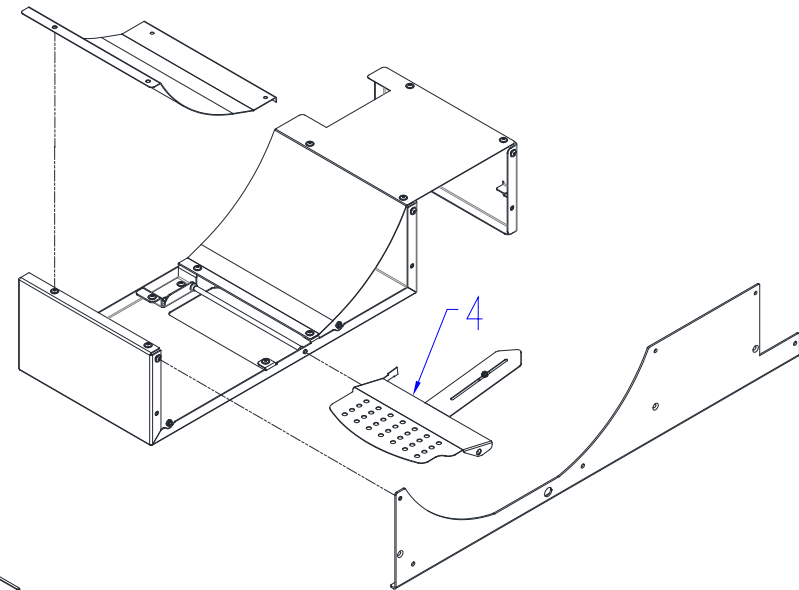
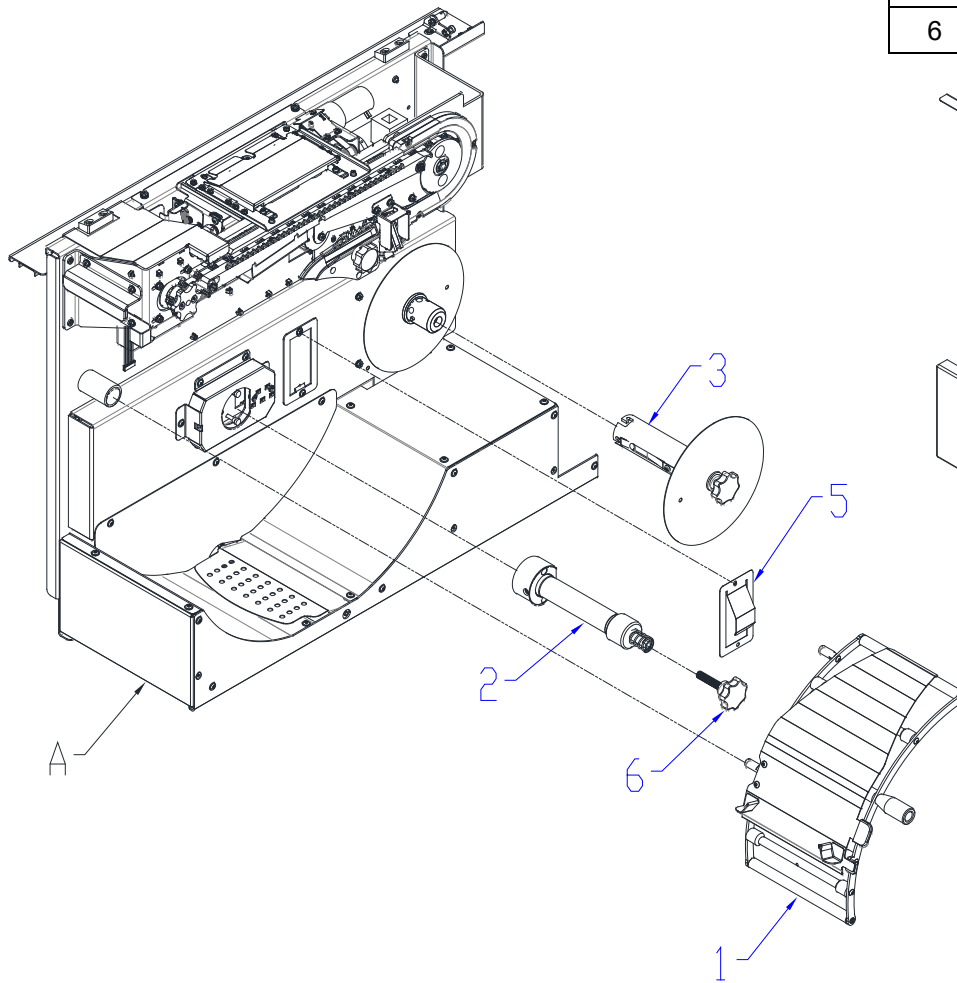

DETAIL - A



**PL 5.11 ELEMENT FEEDER - KNIFE MODULE**

ITEM	GBC PART #	DESCRIPTION	QTY
1*	7723281 7723253	Element Detect at Knife Sensor (S21)	1
2	7715340	Knife Home Sensor (S23)	1
3	-	Knife Anvil with Hardware	1
4	-	Knife Blade	1
5	-	Kit, Knife Blade Mounting Hardware	1
6	7723299	Knife, Anvil, and Hardware (items 3-5)	1

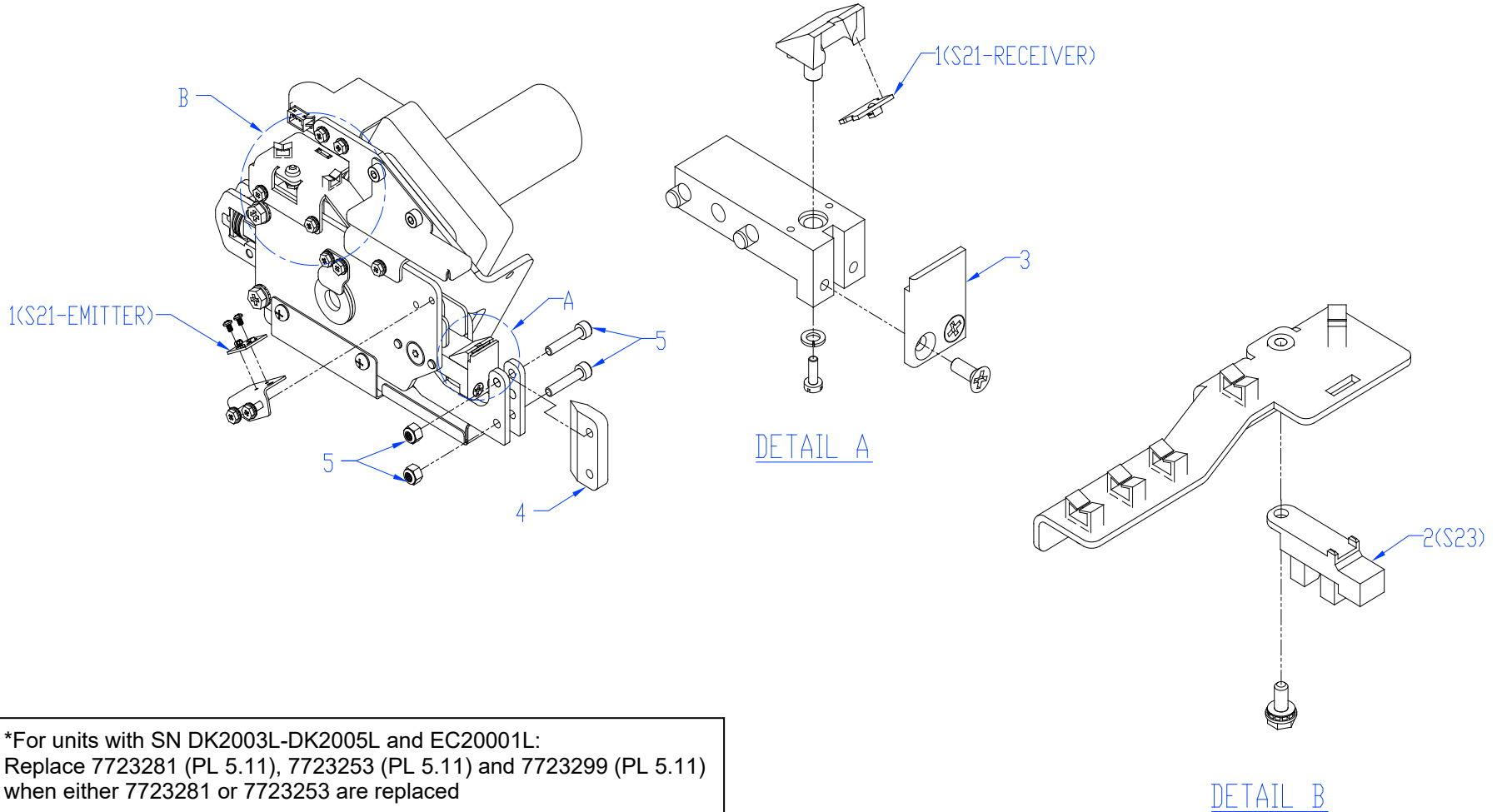

\*For units with SN DK2003L-DK2005L and EC20001L:  
 Replace 7723281 (PL 5.11), 7723253 (PL 5.11) and 7723299 (PL 5.11)  
 when either 7723281 or 7723253 are replaced

**PL 5.12 ELEMENT TRANSFER - SENSORS**

ITEM	GBC PART #	DESCRIPTION	QTY
1	7715340	Expanding T Encoder Sensor (S31)	1
2	7715340	Expanding T Home Sensor (S32)	1
3	7715340	Expanding T Out Sensor (S33)	1
4	7715340	Pushover Home Sensor (S24)	1

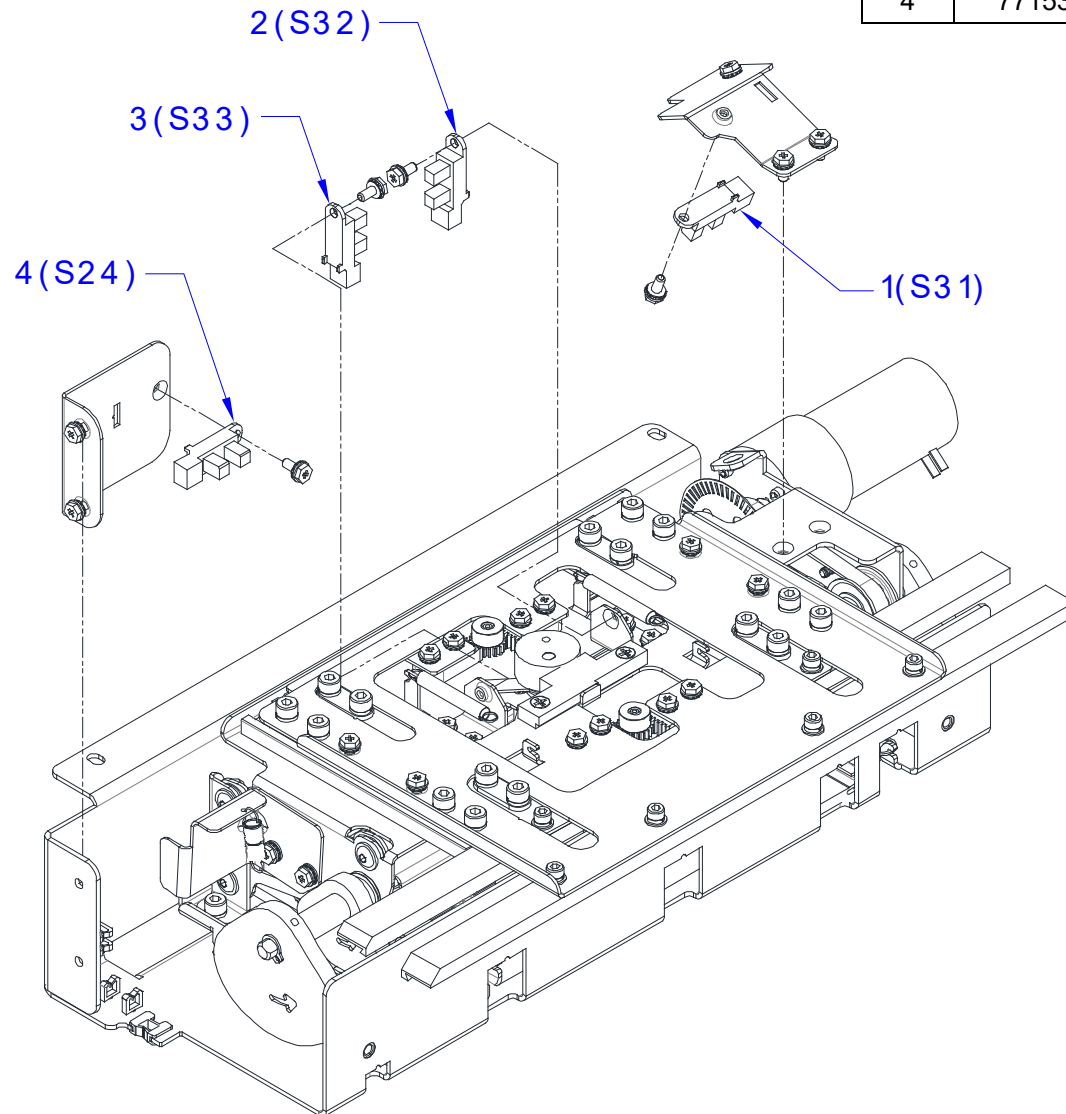

**PL 5.13 ELEMENT TRANSFER - COMPONENTS**

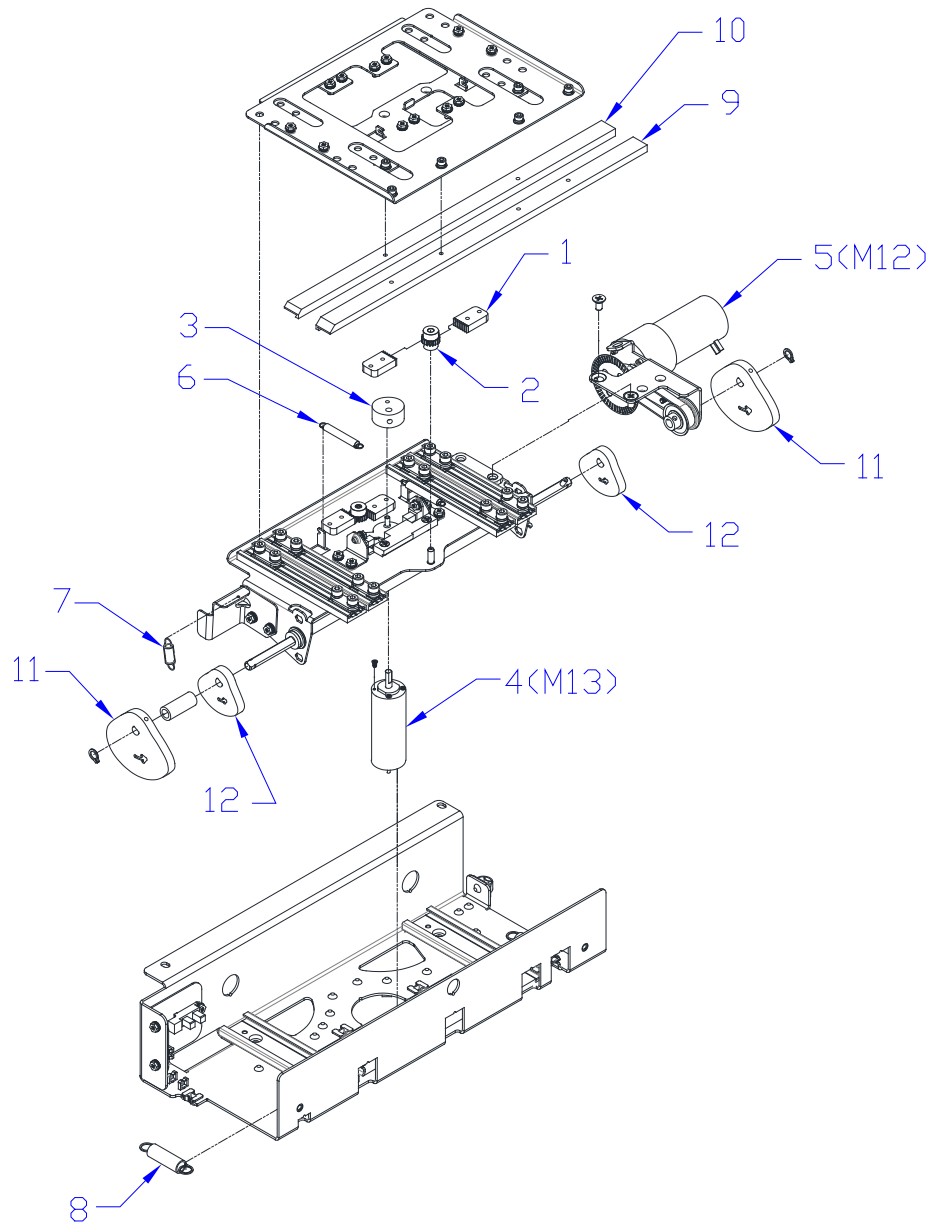

ITEM	GBC PART #	DESCRIPTION	QTY
1	7716901	Expanding T Rack	4
2	7716913	Expanding T Gear	2
3	7716894	Expanding T CAM	1
4	7723853	Expanding T Motor (M13)	1
5	7717682	Pushover Motor Assembly (M12)	1
6	7717415	Expanding T Spring	2
7	7718131	Exp T Motor Counterbalance Spring	1
8	7717411	Element Pushover Spring	2
9	7723816	Expanding T Leading	1
10	7723817	Expanding T Trailing	1
11	7716897	Expanding T, Pushover CAM, Horizontal	2
12	7716898	Expanding T, Pushover CAM, Vertical	2

PL 5.14 VACUUM STACKER - MOTORS & SOL

ITEM	GBC PART #	DESCRIPTION	QTY
1	7718112	Kick Down Solenoid Assembly (L7)	2
2	7715289	Drag Finger Solenoid (L6)	1
3	7715200	Stacker Drive Motor (M5)	1

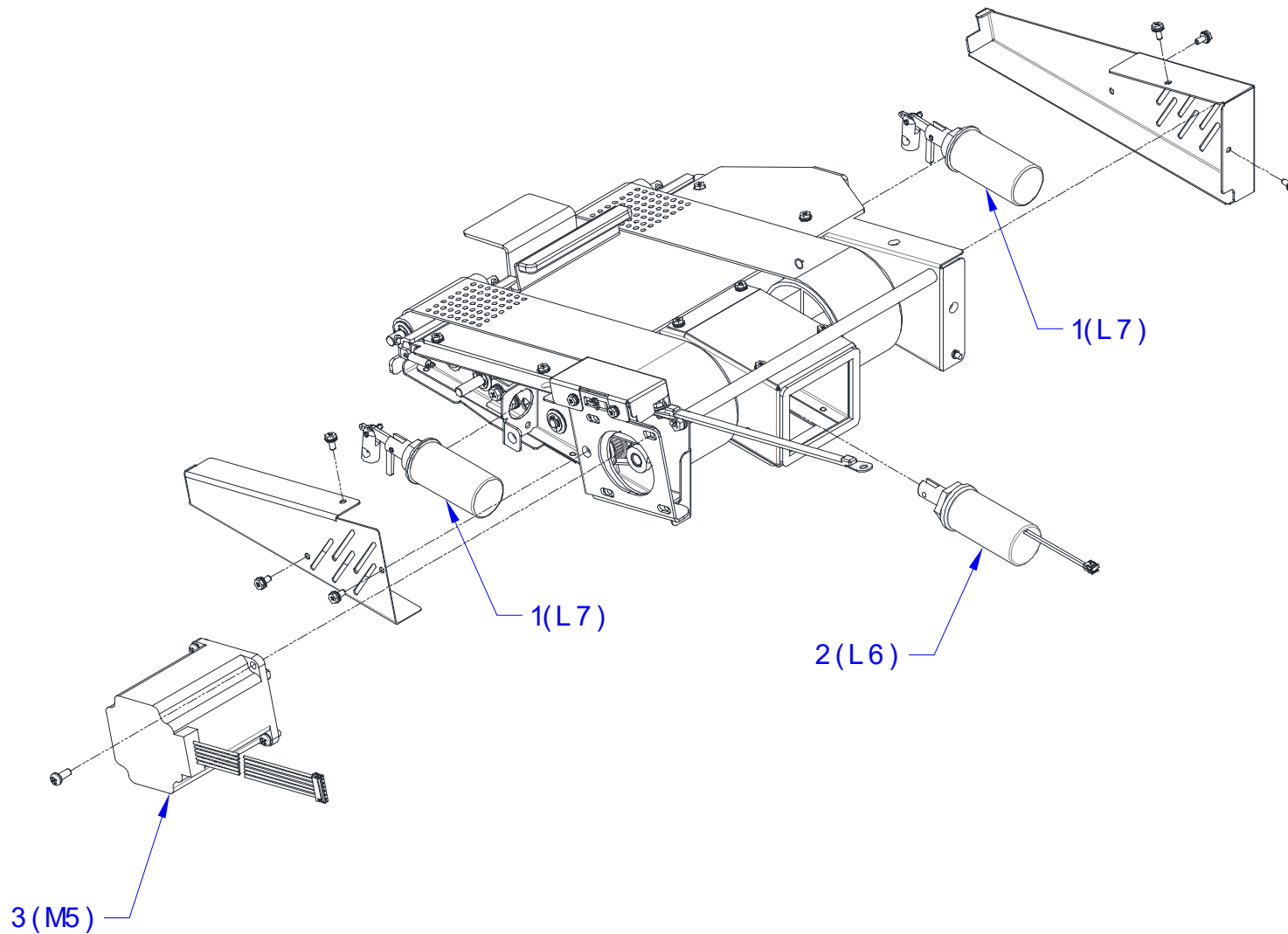

**PL 5.15 VACUUM STACKER - MECHANICAL**

ITEM	GBC PART #	DESCRIPTION	QTY
1	7718111	Idler Pulley Sub Assembly	2
2	7716828	Kick Down	2
3	7716829	Kick Down, Reverse	2
4	7716803	Stacker Drive Belt	1
5	7716808	Vacuum Stacker Belt	2
6	7718138	Drag Finger Adhesive Grip	1

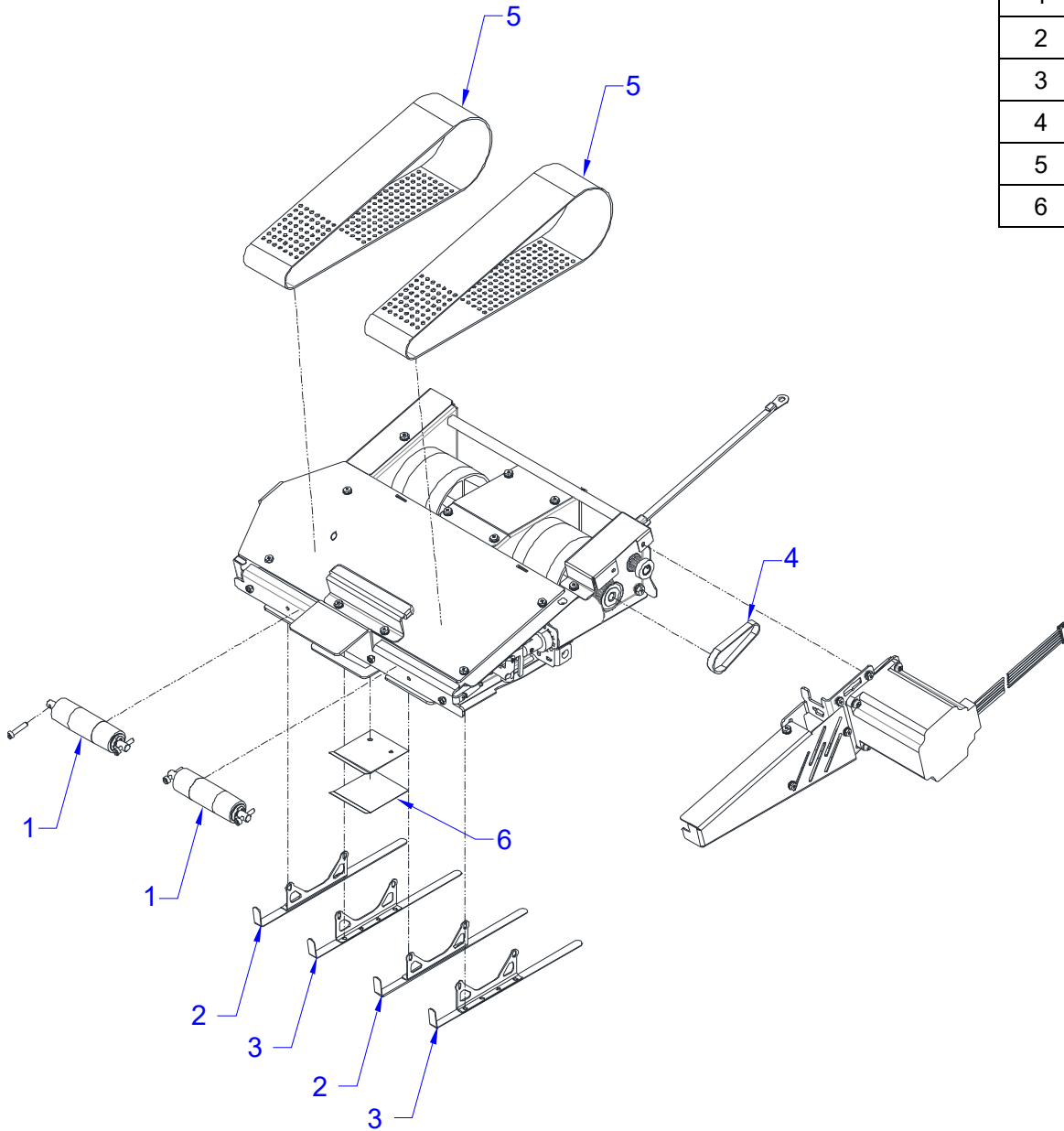

**PL 5.16 DEFLECTOR MODULE**

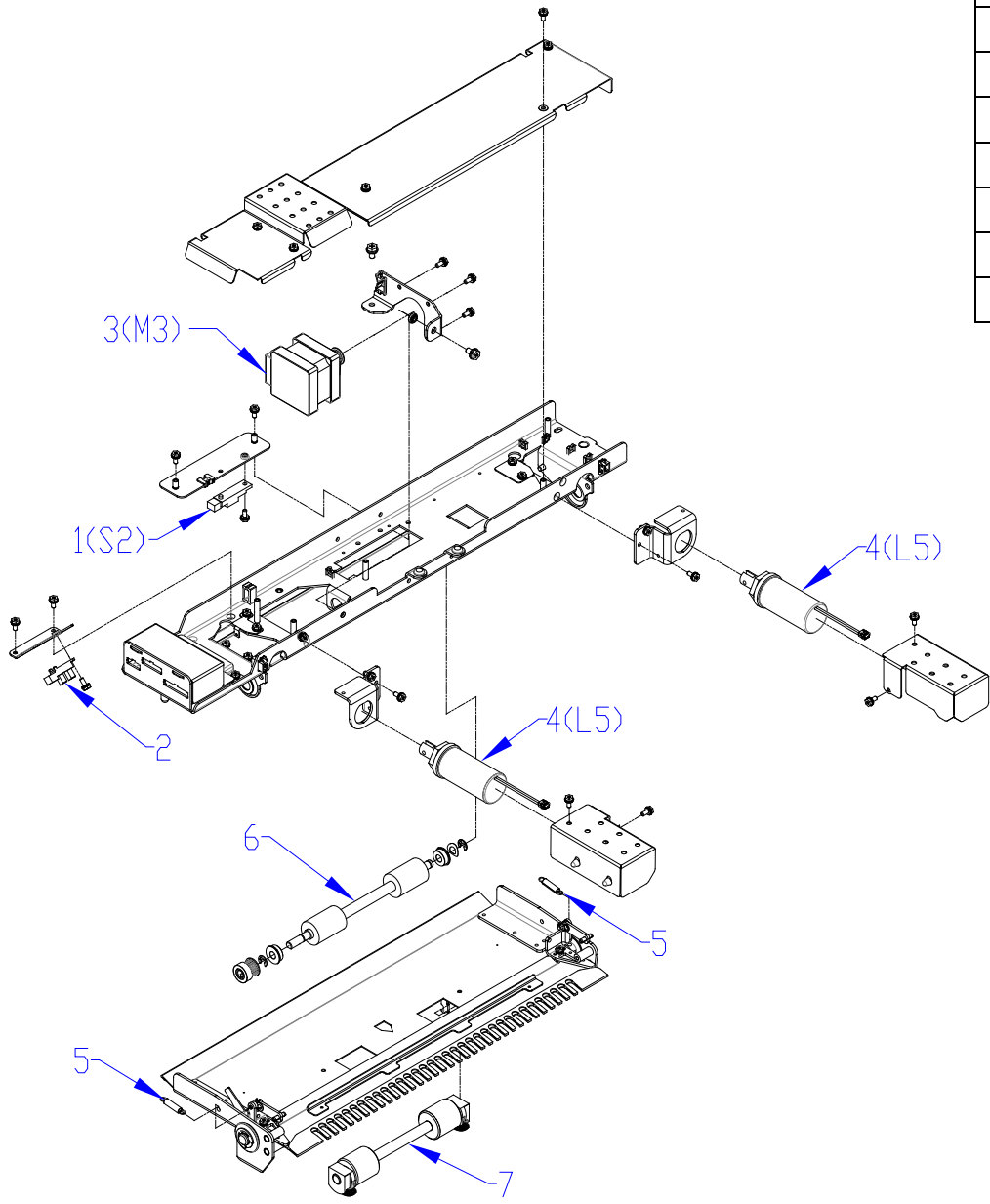

ITEM	GBC PART #	DESCRIPTION	QTY
1	7715193	Bind Kick-Down Sensor (S2)	1
2	7715193	Bind Deflect Sensor (S3)	1
3	7723292	Bind Path Motor (M3)	1
4	7718113	Deflector Solenoid Linkage (L5)	2
5	7717429	Deflector Spring	2
6	7716548	Drive Roller Assembly	1
7	7718381	Idler Roller Assembly	1
8	7715340	Deflect Position Sensor (S17)	1

**PL 5.17 TAPPER MODULE - FRONT**

ITEM	GBC PART #	DESCRIPTION	QTY
1	7723850	Tapper Motor (M6)	1
2	7717404	Tapper Spring	1
3	7715340	Tapper Sensor (S18)	1
4	7716574	Tapper Finger	1

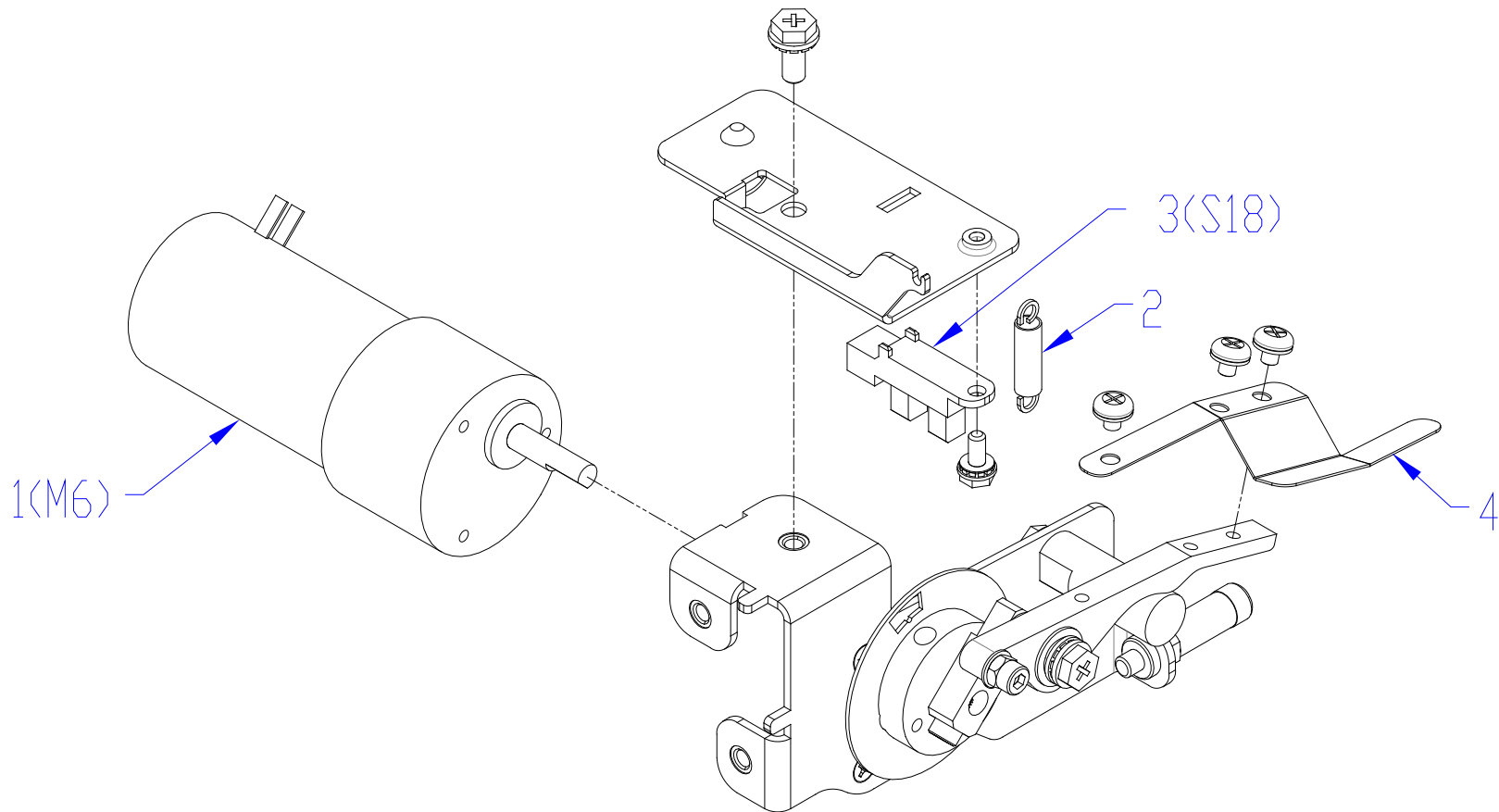

PL 5.18 TAPPER MODULE - REAR

ITEM	GBC PART #	DESCRIPTION	QTY
1	7723850	Tapper Motor (M7)	1
2	7717404	Tapper Spring	1
3	7715340	Tapper Sensor (S19)	1
4	7716860	Finger, Sheet Tapper, Rear	1

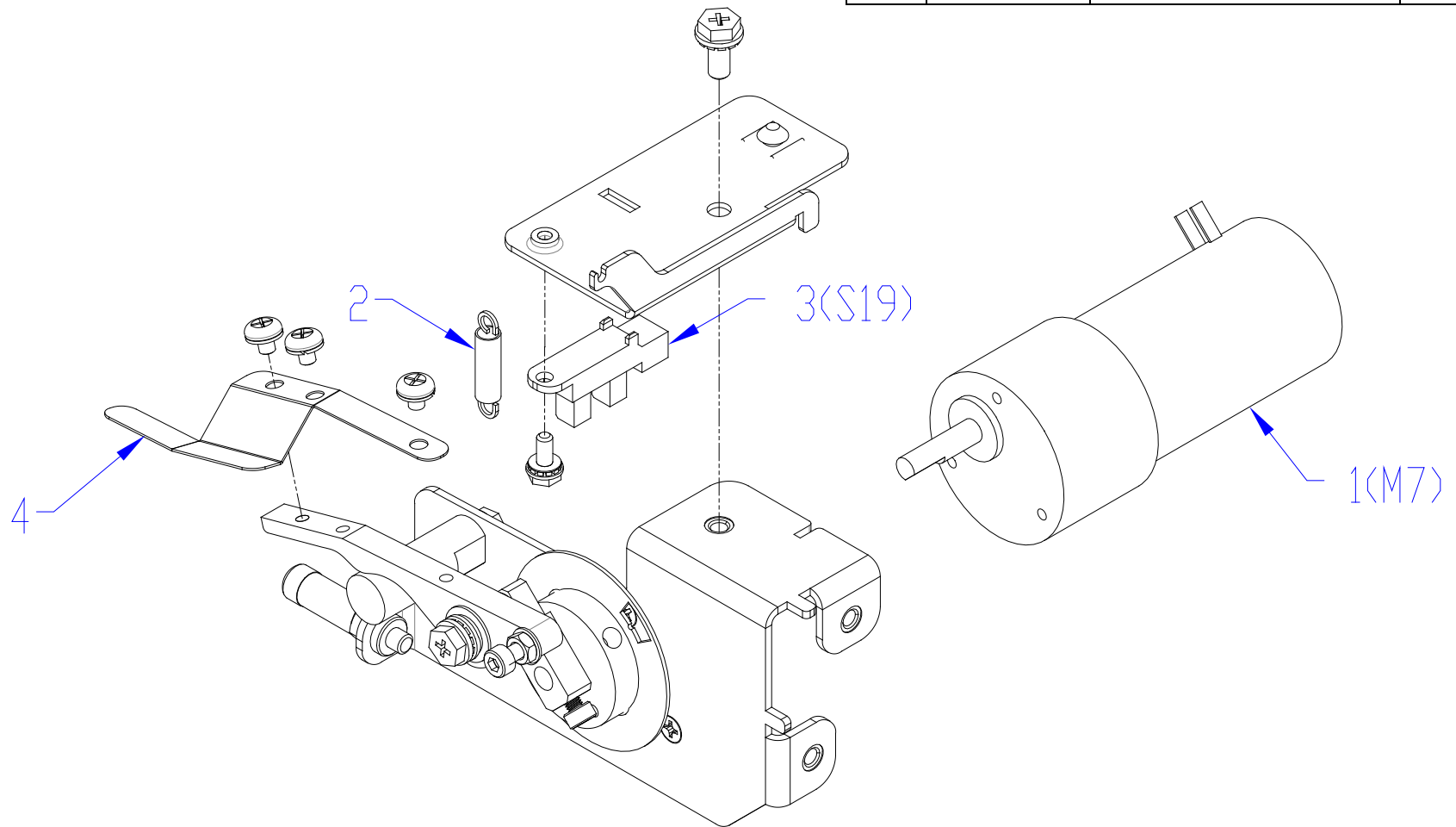



PL 5.19 CLOSER MODULE

ITEM	GBC PART #	DESCRIPTION	QTY
1	7715340	Closer Encoder Sensor (S48)	1
2	7715340	Closer Full Open Sensor (S47)	1
3	7723852	Closer Motor (M20)	1
4A*	7717658	Closer Jaw, Upper Insert	12
4B	7723288	Closer Jaw, Lower	1
5	7716760	Closer Jaw Spring	2
6	7715289	Solenoid, Book Eject	1
7	7723074	Tensioner Assembly	1
8	7723071	Roller Chain	1
9	7716781	Disk Encoder	1
10	7723070	Sprocket 15T	2
11	Z7723211	Closer front assembly with cable.	1

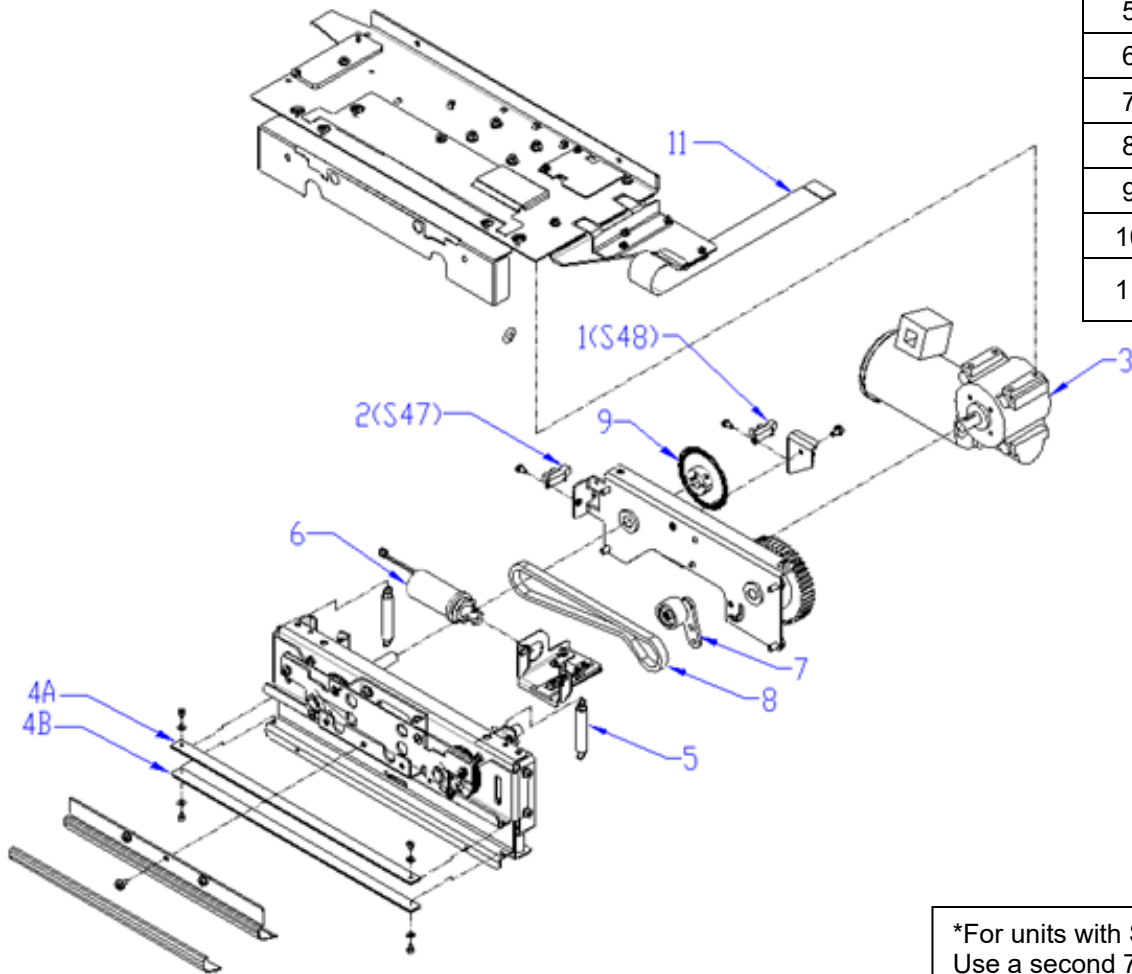

\*For units with SN prior to GGxxxxx:  
Use a second 7717658 in place of 7723288 unless the machine has been upgraded to run F size elements.

PL 5.20 HOLDER - SENSORS

ITEM	GBC PART #	DESCRIPTION	QTY
1	7715340	Closer Staged Sensor (S49)	1
2	7715340	Closer Home Sensor (S46)	1
3	7715340	Holder Position Closer Sensor (S36)	1
4	7715340	Holder Position Stack Sensor (S37)	1
5	7715340	Holder Position Element Sensor (S38)	1
6	7715340	Holder at Reverse Gate Sensor (S39)	1
7	7715340	Holder Near Element Feeder Sensor (S40)	1

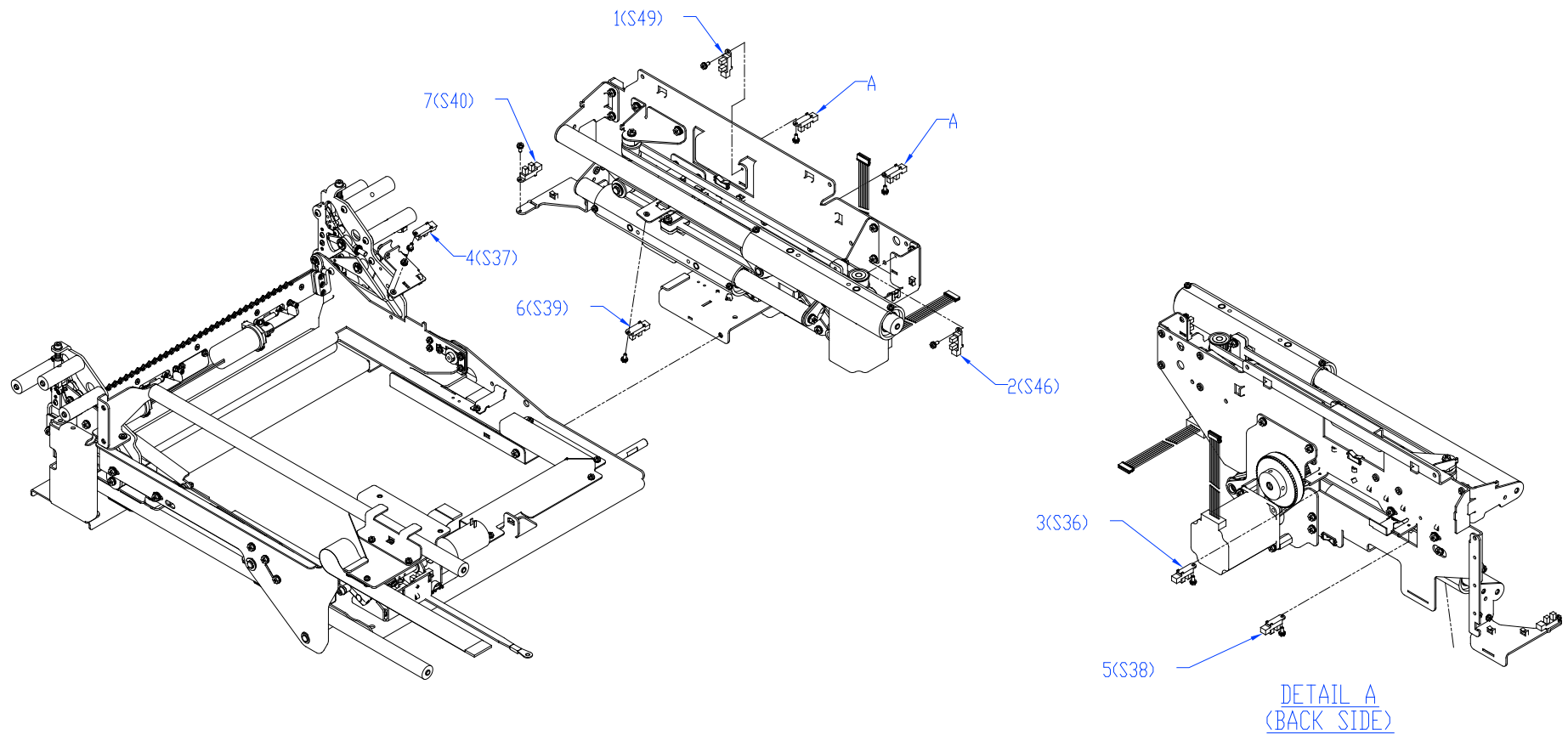

**PL 5.21 HOLDER - MOTORS, BELTS & SPRINGS**

ITEM	GBC PART #	DESCRIPTION	QTY
1	7715200	Holder Linear Motor (M15)	1
2	7715200	Closer Linear Motor (M21)	1
3	7718423	Closer Linear Drive Belt	1
4	7718427	Holder Linear Drive Belt	1
5	7717404	Holder Gates Spring Lower	2
6	7717685	Holder Gates Spring Upper	2
7	7718183	Linear Spring Plate Assembly	2

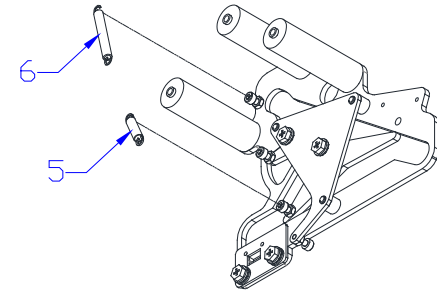
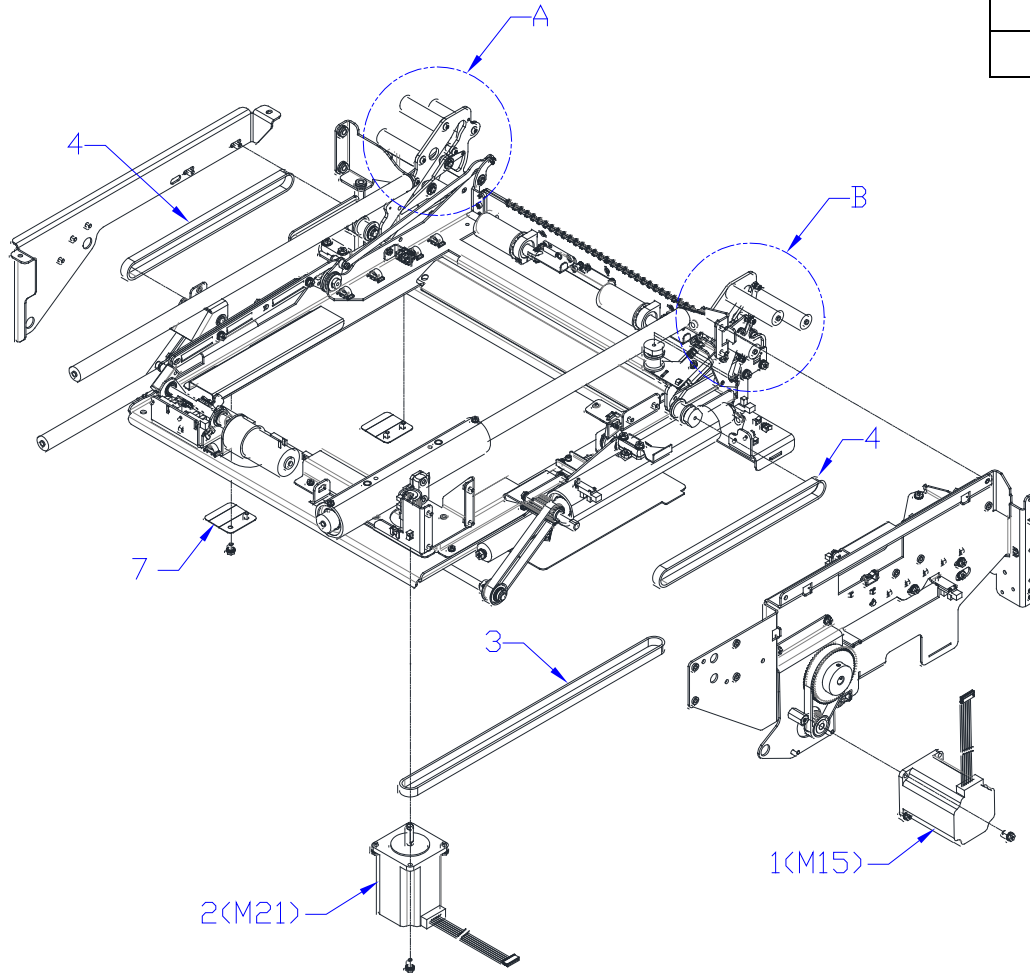

DETAIL A

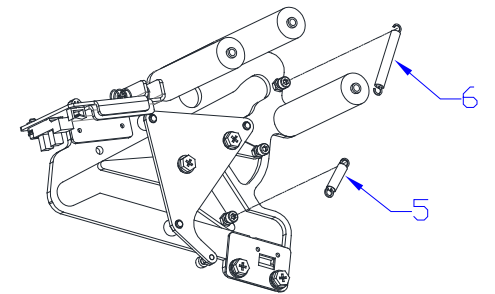

DETAIL B

**PL 5.22 HOLDER - LOCK & ROTATE ASSEMBLIES**

ITEM	GBC PART #	DESCRIPTION	QTY
1	7715340	Holder Rotate Horizontal Sensor (S35)	1
2	7715340	Holder Rotate Vertical Sensor (S34)	1
3	7718056	Holder Rotate Motor (M14)	1
4	7723244	Holder Solenoid Assembly, Ribbon Cable (L8)	1
5	7716612	Holder Lock Sub-Assembly (Contains 4&6)	1
6	7716674	Hinge, Front, Element Holder	1
7	7716675	Link, Holder Rotate	1
8	7723239	Flat Mylar Cable, Holder	1
9	7723240	Cable Assembly, Holder, Ribbon Adapter	1
10	7723999	Kit, Holder Ribbon Cable	-

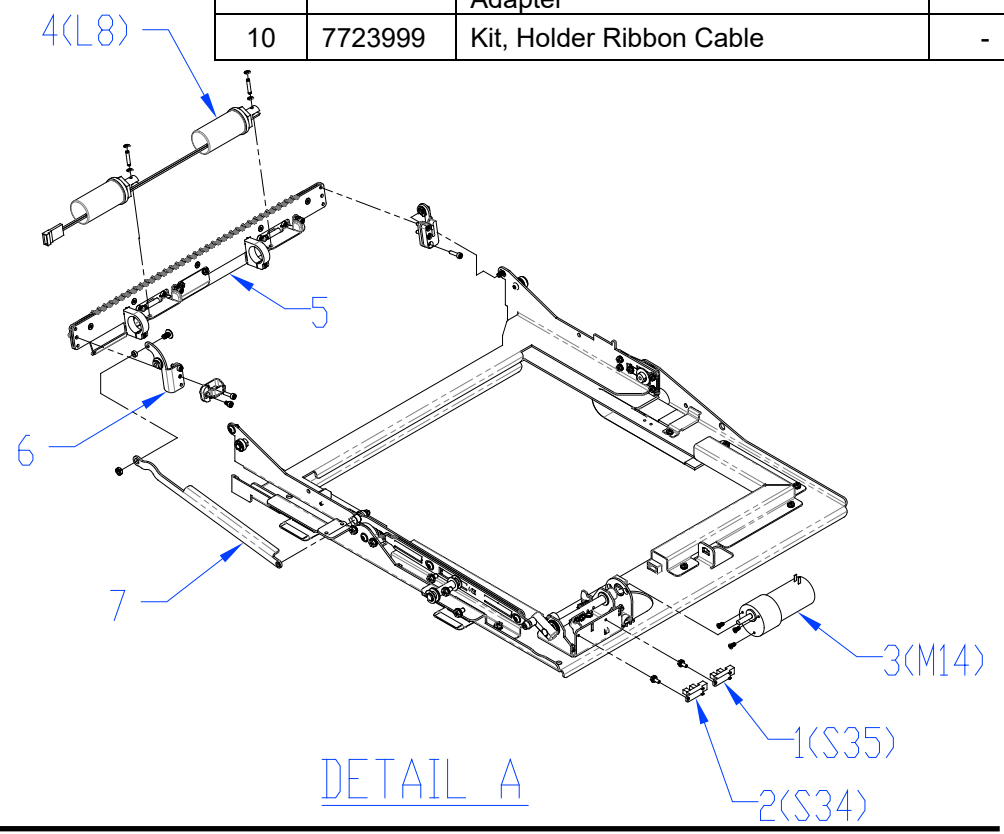
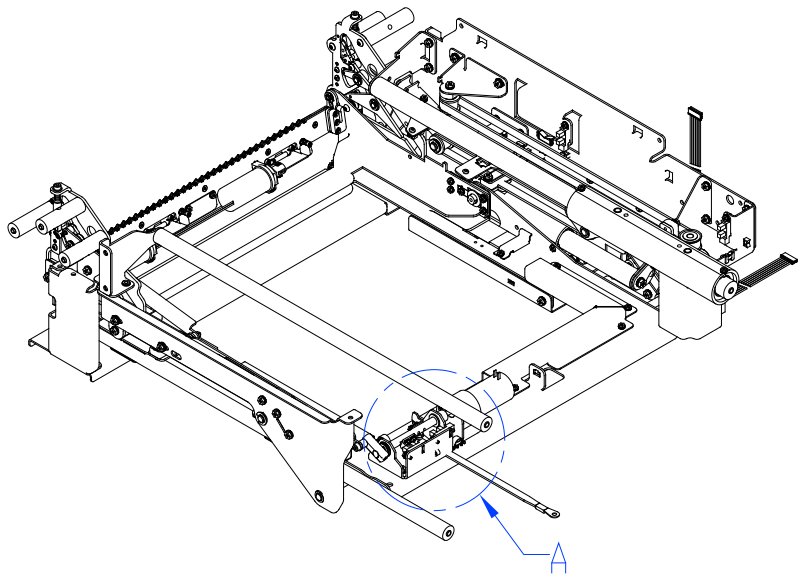

DETAIL A

**PL 5.23 BOOK DRAWER - SENSORS**

ITEM	GBC PART #	DESCRIPTION	QTY
1*	7711970	Drawer Full Up Sensors Emitter (S42)	2
2*	7711973	Drawer Full Up Sensors Receiver (S42)	2
3	7717443	Drawer Full Down Sensors Emitter (S43)	1
4	7717740	Book Drawer Empty Sensor (S45)	1
5	7723851	Book Drawer Drive Motor (M19)	1
6*	7723286	Kit, S42 Aperture Bracket, Service	1

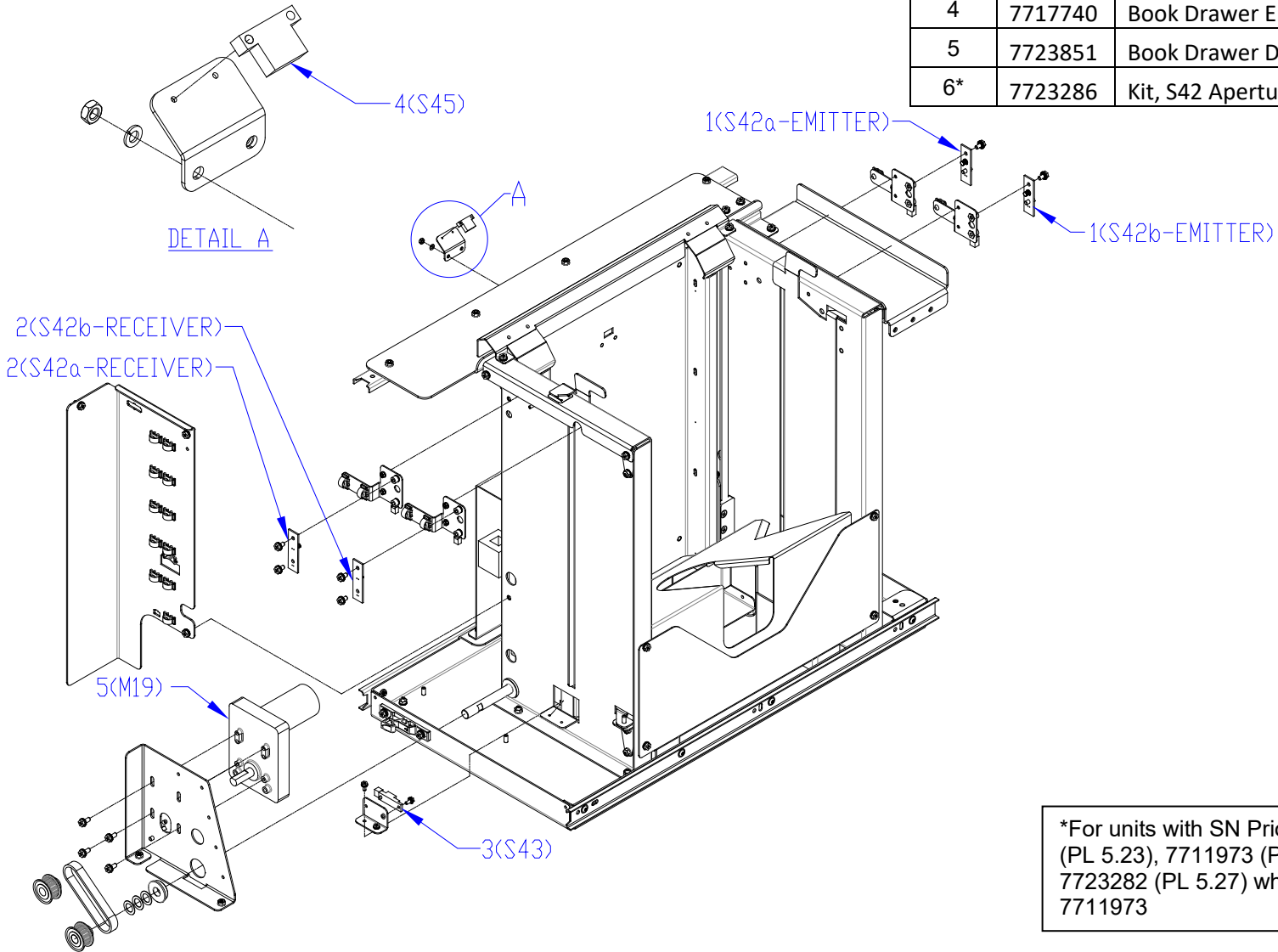

\*For units with SN Prior to ELxxxxxx, replace 7711970 (PL 5.23), 7711973 (PL 5.23), 7723286(PL 5.23) and 7723282 (PL 5.27) when replacing either 7711970 or 7711973

**PL 5.24 BOOK DRAWER - BELTS & PULLEYS**

ITEM	GBC PART #	DESCRIPTION	QTY
1	7717828	Belt, Book Tray Drive Motor	1
2	7718022	Pulley, Book Tray Drive Shaft	2
3	7717818	Belt, Book Tray Vertical Lift	1
4	7717820	Pulley, Book Tray Vertical Lift	2

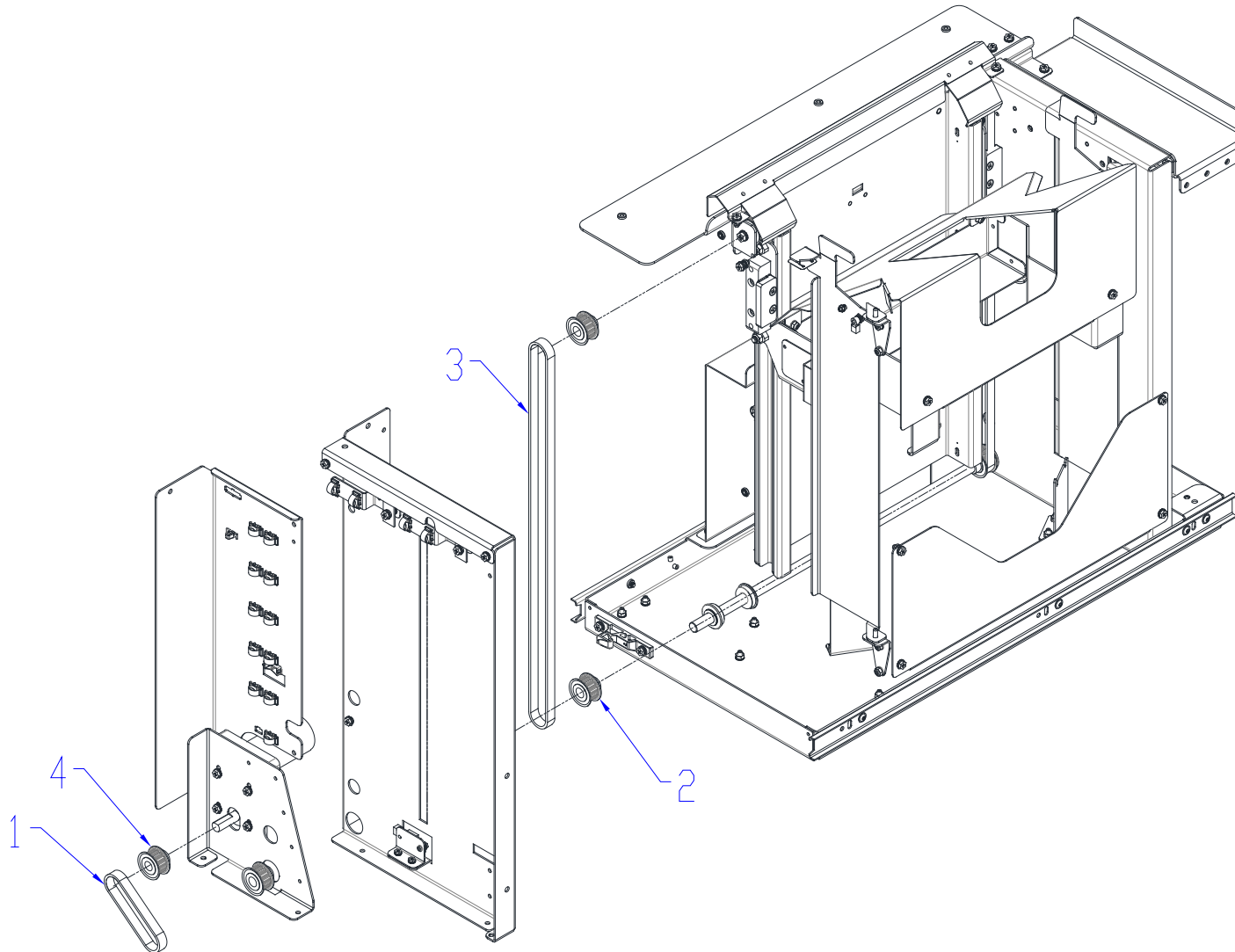

PL 5.25 FRAME - SWITCHES & LATCHES

ITEM	GBC PART #	DESCRIPTION	QTY
1	7724859	Interlock Switch	2
2	7706486	Latch	2
3	7723794	Drawer, Lockout, Finger	1
4	7301296	Snap Switch	1

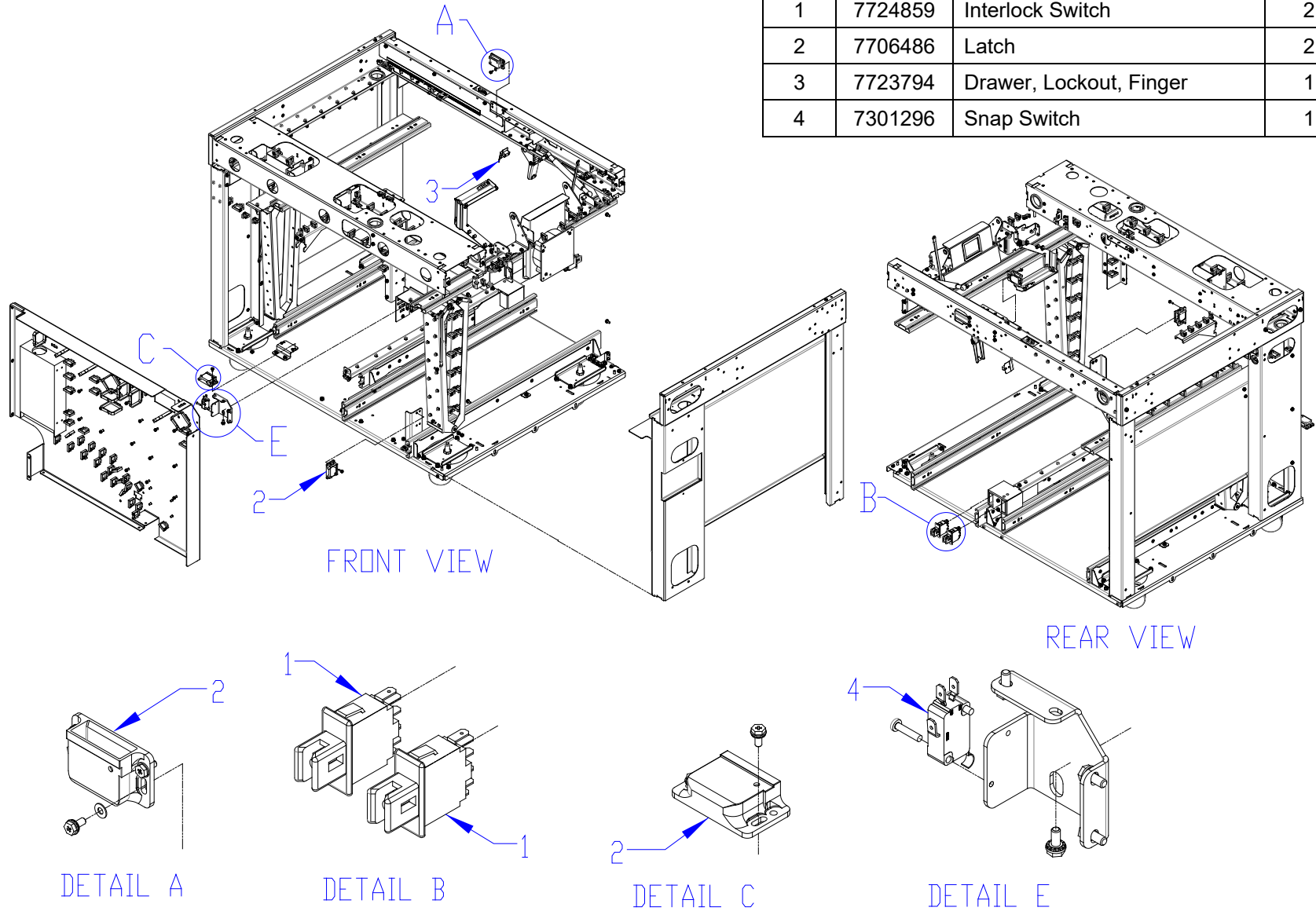

PL 5.26 FRAME - VACUUM & LOCKOUT

ITEM	GBC PART #	DESCRIPTION	QTY
1	7715275	Stepper Driver Board	4
2	7717339	Vacuum Fan	1
3	7715193	Stacker Paper Detect Sensor (S44)	1
4	7717237	Vacuum Duct Gasket	1
5	7723794	Element Drawer Lockout Finger	1
6	7717644	Element Drawer Lockout Linkage	1

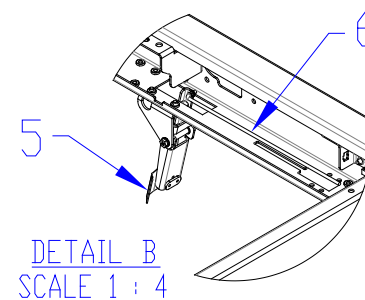
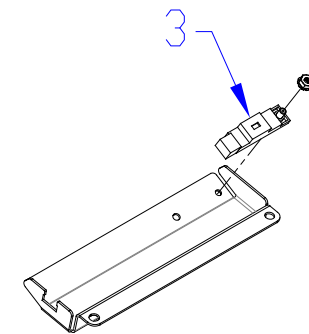
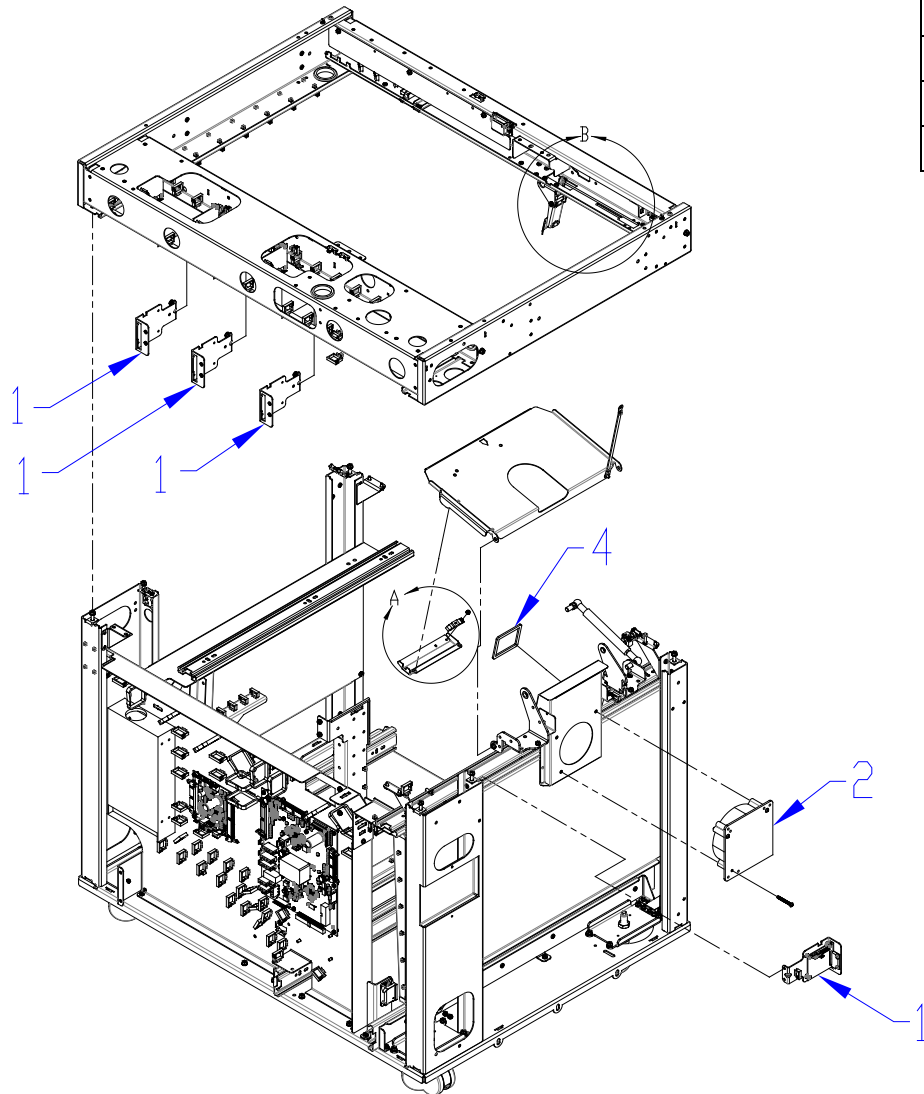



**PL 5.27 ELECTRICAL COMPONENTS**

ITEM	GBC PART #	DESCRIPTION	QTY
1	7716592	Main Control Board A-C	1
2*	7723282	Main Control Board B, NBDR	1
3	7715637	24 VDC Power Supply	1
4	6195001	RFI Filter	1
5	7704376	AC Power Rocker Switch	1

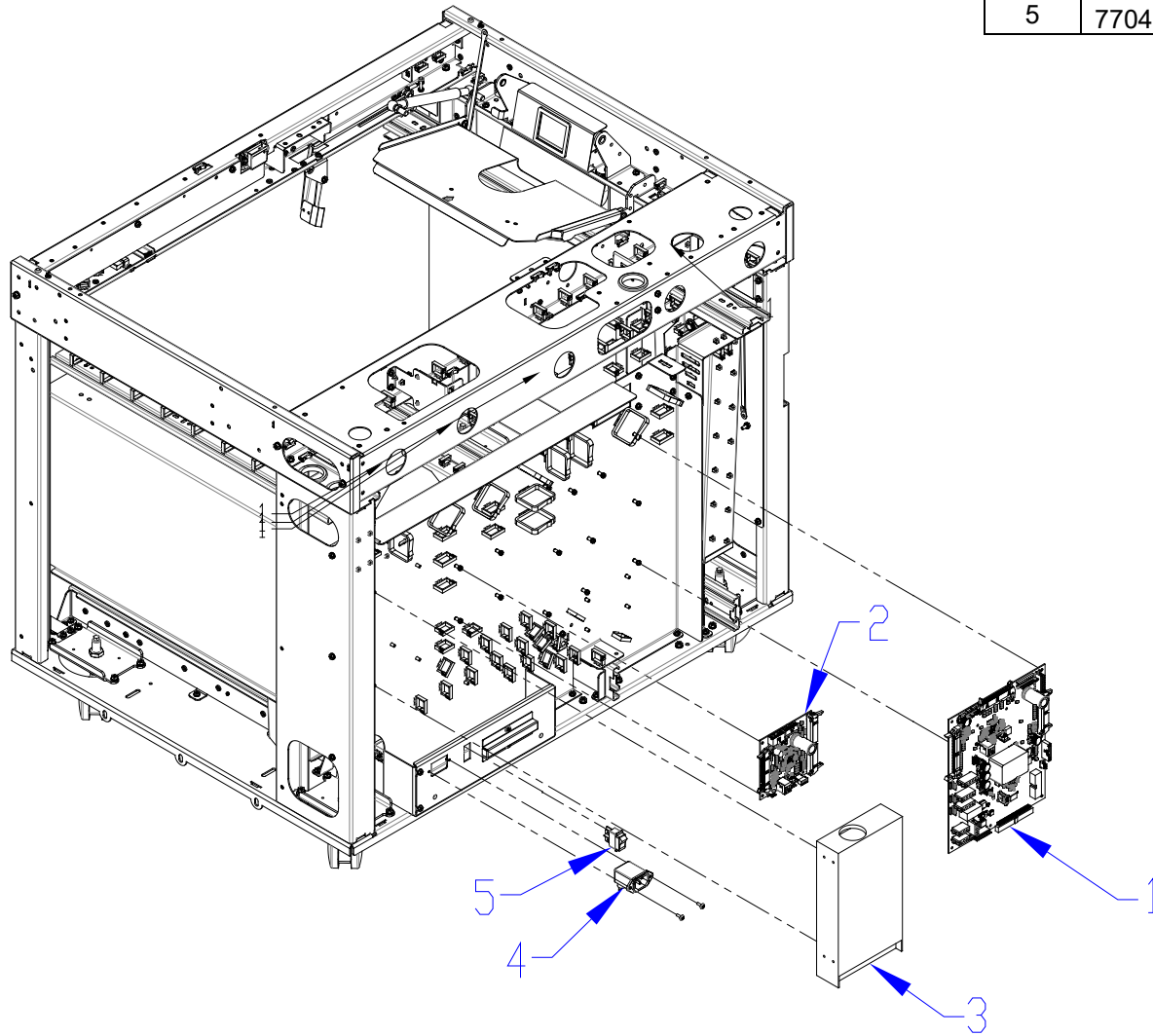

\*For units with SN Prior to ELxxxxxx, replace 7711970, 7711973, and 7723286 when replacing 7723282

**PL 5.28 OUTER COVERS**

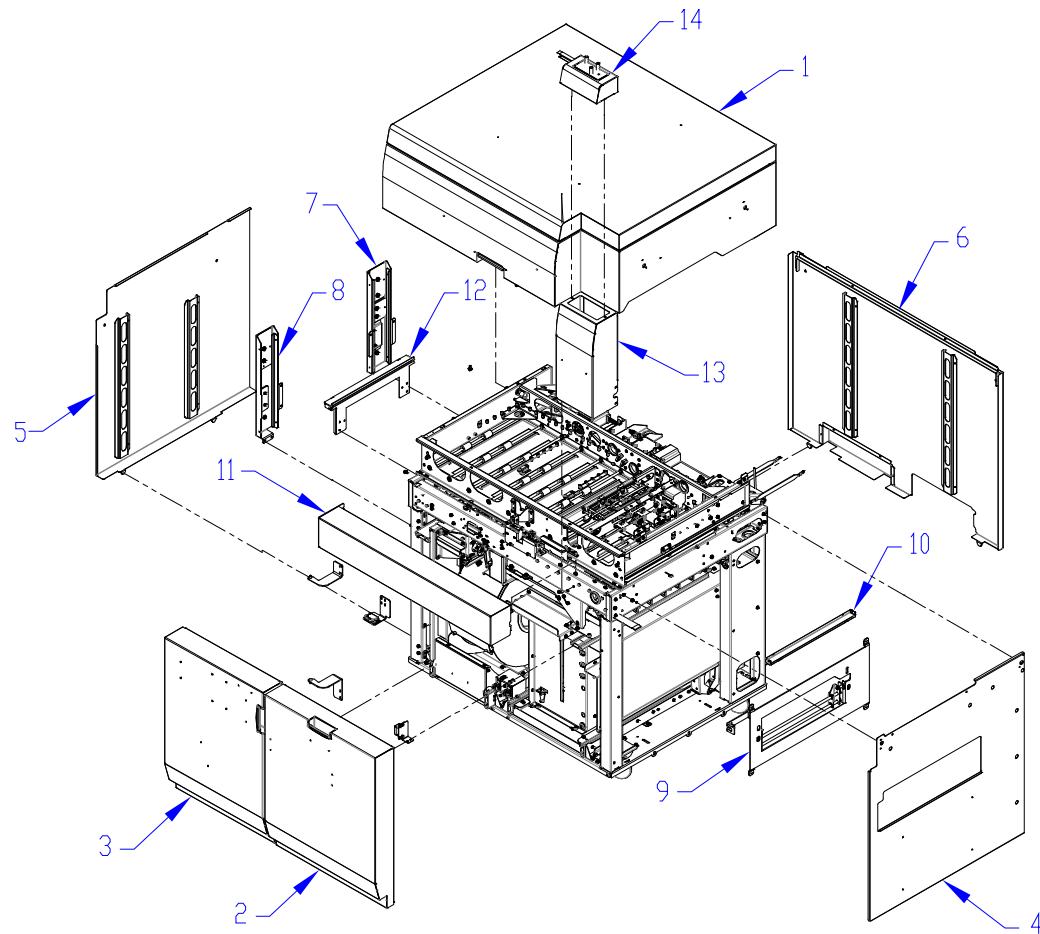

ITEM	GBC PART #	DESCRIPTION	QTY
1	7718205	Top Cover Assembly	1
2	7718219	Door, Book Tray	1
3	7718229	Door, Element Feeder	1
4	7718233	Side Panel Assembly, Left	1
5	7718237	Side Panel Assembly, Right	1
6	7718238	Back Cover Assembly	1
7	7718212	Docking Bracket, Rear	1
8	7718213	Docking Bracket, Front	1
9	7718228	Docking Bracket Assembly	1
10	7717700	Paper Infeed Guide	1
11	7718253	Front Cover Panel Assembly	1
12	7717703	Paper Outfeed Guide	1
13	7718224	LCD Tower	1
14	7718216	LCD Tower Cap (with LCD)	1

**PL 5.29 MAIN ASSEMBLY (MODULES)**

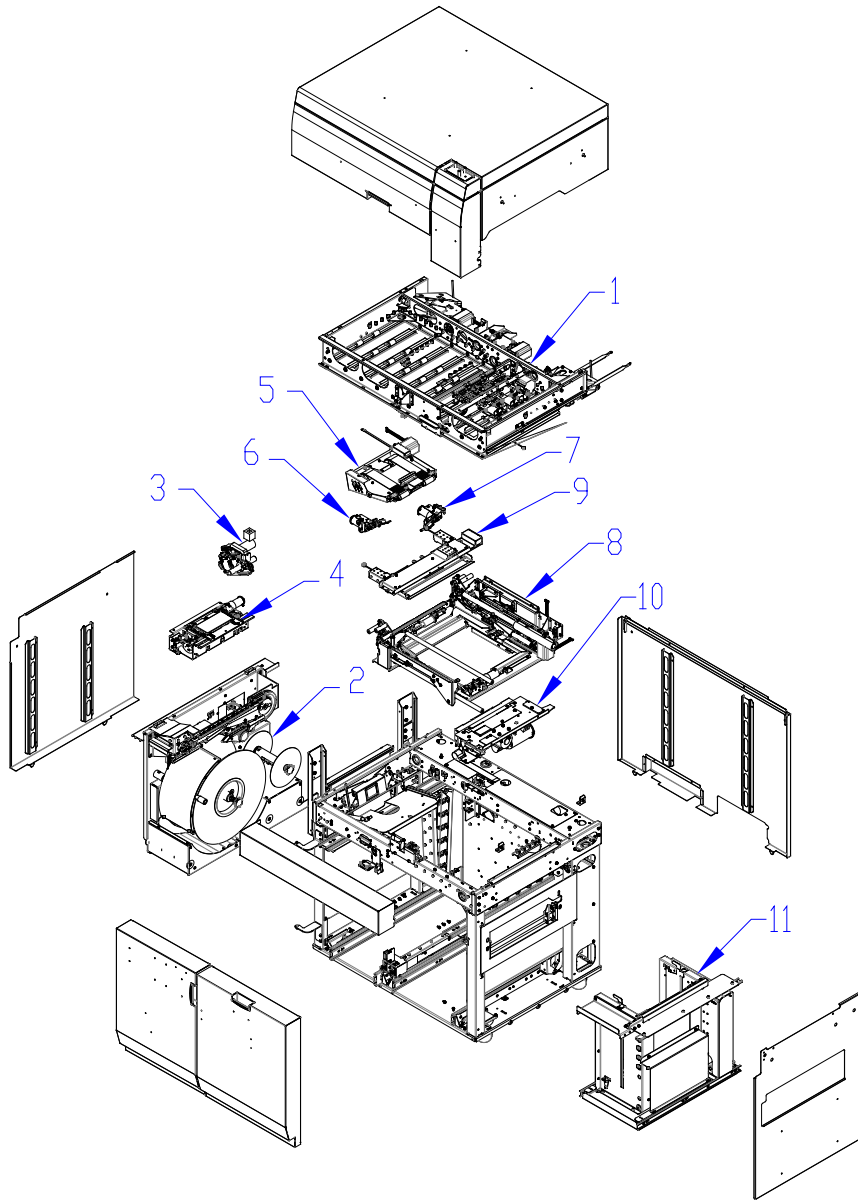

ITEM	GBC PART #	DESCRIPTION	QTY
1	-	Paper Transport Complete Assy	1
2	7716970	Element Feeder	1
3	7716862	Knife Assy	1
4	7716887	Element Transfer, Module Assy	1
5	7716805	Module, Vacuum, Conveyor	1
6	7716863	Front Tapper Assy	1
7	7716874	Rear Tapper Assy	1
8	-	Holder Module	1
9	7717350	Deflector Module, FWD	1
10	7716762	Closer Module	1
11	7717420	Book Drawer, Complete	1

**PL 5.30 TOOLS & KITS**

<b>ITEM</b>	<b>GBC PART #</b>	<b>DESCRIPTION</b>
1	7717881	Element Height Setup Tool
2	7717879	Punched Hole Position Check
3	7718072	Magnet, eWire Spool
4	7718648	Wipes, Cleaning, Anti-Static
5	7718064	Instruction Sheet, Spool Replacement
6	7723287	Kit, Spare Fasteners, eWire, Service

**PL 5.31 CABLES**

<b>GBC PART #</b>	<b>DESCRIPTION</b>
Z7716701	WIRE HARNESS, VACUUM STACKER INTERNAL
Z7716702	WIRE HARNESS, CLOSER MODULE INTERNAL
Z7716703	CABLE ASSY, PCB TO CLOSER
Z7716704	CABLE ASSY, KNIFE MODULE
Z7716706	CABLE ASSY, HOLDER INTERNAL, USER SIDE
Z7716709	CABLE ASSY, PCB TO HOLDER MODULE
Z7716711	CABLE ASSY, PCB TO ELEMENT FEEDER HEADER
Z7716712	CABLE ASSY, SHEET TAPPERS
Z7716713	CABLE ASSY, LCD
Z7716714	CABLE ASSY, INTERLOCK, ELEMENT FEEDER
Z7716715	CABLE ASSY, INTERLOCK, BOOK DRAWER
Z7716716	CABLE ASSY, INTERLOCK, TOP COVER
Z7716717	CABLE ASSY, ELEM. FEEDER MOVEABLE CABLE #1
Z7716718	CABLE ASSY, ELEM. FEEDER MOVEABLE CABLE #2
Z7716719	CABLE ASSY, ELEM. FEEDER MOVEABLE CABLE #3
Z7716720	CABLE ASSY, ELEM. FEEDER INTERNAL #1
Z7716721	CABLE ASSY, ELEM. FEEDER INTERNAL #2
Z7716723	CABLE ASSY, 24VDC, ELEM. FEEDER INTERNAL
Z7716724	CABLE ASSY, 24VDC, ELEM. FEEDER, MOVEABLE
Z7716725	CABLE ASSY, 24VDC, PCB TO MOTOR DRIVERS #1
Z7716726	CABLE ASSY, 24VDC, SUPPLY TO PCB
Z7716727	CABLE ASSY, AC, NEUTRAL, INLET FILER TO SWITCH
Z7716730	CABLE ASSY, PCB TO BOOK DRAWER
Z7716731	CABLE ASSY, BOOK DRAWER, MOVEABLE HARNESS
Z7716732	CABLE ASSY, BOOK DRAWER MODULE, INTERNAL
Z7716734	CABLE ASSY, PCB INTERLINK, B TO A
Z7716737	CABLE ASSY, ALIGNMENT MODULE SENSOR BOARD
Z7716738	CABLE ASSY, SKEW BOARD
Z7716740	CABLE ASSY, 24VDC, MOTOR DRIVERS #3
Z7716741	CABLE ASSY, 24VDC, MOTOR DRIVERS #4
Z7716742	CABLE ASSY, 24VDC, SUPPLY TO PCB B
Z7716743	CABLE ASSY, GROUND WIRE, 20cm
Z7717197	CABLE, STEPPER DRIVER TO MOTOR
Z7717198	CABLE STEERING, MTR TO HDR
Z7717199	CABLE STEERING, DRV TO HDR
Z7717347	FLAT MYLAR CABLE, HOLDER
Z7717348	FLAT MYLAR CABLE, CLOSER
Z7717472	CABLE ASSY, ELEM TRANSFER, EXTENSION
Z7717473	CABLE ASSY, ELEM TRANSFER, INTERNAL

Z7717870	CABLE, PSU TO A-C BOARD, EWIRE
Z7717871	CABLE, SWITCH TO A-C BOARD, EWIRE
Z7718556	JUMPER , BOOK DRAWER
Z7718656	CABLE, COMMS, EWIRE TO SPARTA, INTERNAL
Z7723151	CABLE, EXTENSION, VACUUM STACKER MOTOR
Z7723193	CABLE, EF SWITCH CLOSE
Z7723239	CABLE ASSY, HOLDER, RIBBON ADAPTER
Z7723240	FLAT MYLAR CABLE, HOLDER
Z7723211	CLOSER FRONT ASSY WITH CABLE
Z7723185	ASM, COMM CABLE & USB COVER

---

---

## 6. General Procedures and Information

### Section Contents

Title	Page		Page
GP 6.1 eWire User Interface Options.....	6-3	GP 6.3.22 Factory Only.....	6-23
GP 6.1.1 Accessing the User Interface Menu.....	6-3	GP 6.4 Check Sensors.....	6-24
GP 6.1.2 User Interface Options Flowchart.....	6-4	GP 6.4.1 Check S1-S5, S16, S43, S45.....	6-24
GP 6.1.3 Accessing the Service Interface Menu.....	6-5	GP 6.4.2 Check S6-S10, S12, S13, and S15.....	6-26
GP 6.1.4 Service Menu Flowchart.....	6-6	GP 6.4.3 Check S18-S20, S24, S31-S41, S46-S49.....	6-28
GP 6.2.....	6-7	GP 6.4.4 Check S21, S22, S25, S42.....	6-34
User Interface Procedures.....	6-7	GP 6.4.5 Check S26 - S30, S50.....	6-37
GP 6.2.1.1 Alignment Setting Adjustment Procedure.....	6-7	GP 6.4.6 Check S47, S48.....	6-39
GP 6.2.1.2 DEFLECTOR Procedure.....	6-7	GP 6.5 MOTOR CHECKS.....	6-41
GP 6.2.2 Closing Setting Adjustment Procedure.....	6-7	GP 6.5.1 Check M1, M2, M4, M16, M17, and M18.....	6-41
GP 6.2.3 Paper Size Select Procedure.....	6-8	GP 6.5.2 Check M3 & M5.....	6-43
GP 6.2.4 LANGUAGE Selection Procedure.....	6-8	GP 6.5.3 Check M6 and M7.....	6-44
GP 6.2.5 MODE Selection Procedure.....	6-9	GP 6.5.4 Check M8.....	6-46
GP 6.2.6 Wire Size Display Procedure.....	6-9	GP 6.5.5 Check M9 and M10.....	6-47
GP 6.2.7 COUNTS Display Procedure.....	6-10	GP 6.5.6 Check M11.....	6-49
GP 6.2.8 FIRMWARE Display Procedure.....	6-10	GP 6.5.7 Check M12 and M13.....	6-50
GP 6.3 Service Interface Procedures.....	6-11	GP 6.5.8 Check M15 and M21.....	6-51
GP 6.3.1 SENSOR Check Procedure.....	6-11	GP 6.5.9 Check M14.....	6-53
GP 6.3.2 SOLENOIDS Procedure.....	6-12	GP 6.5.10 Check M19.....	6-54
GP 6.3.3 MOTORS Procedure.....	6-12	GP 6.5.11 Check M20.....	6-55
GP 6.3.4 FUNCTION TESTS Procedure.....	6-13	GP 6.6 SOLENOID CHECKS.....	6-56
GP 6.3.5 FIRMWARE UPGRADE Procedure.....	6-14	GP 6.6.1 Check Solenoids L1, L2, L3, and L4.....	6-56
GP 6.3.6 ELEMENT SETTINGS Procedure.....	6-15	GP 6.6.2 Check L5 Deflector Solenoids.....	6-58
GP 6.3.7 DEFLECTOR Procedure.....	6-15	GP 6.6.3 Check L6 and L7 Vacuum Module Solenoids..	6-59
GP 6.3.8 FILES Procedure.....	6-16	GP 6.6.4 Check L8 Holder Lock Solenoid.....	6-60
GP 6.3.9 VOLTAGE.....	6-17	GP 6.6.5 Check L9 Book Eject Solenoid.....	6-61
GP 6.3.10 MAX BYPASS Setting.....	6-17	GP 6.7 Supply Spool Installation.....	6-62
GP 6.3.11 FEED BELT HOME Setting.....	6-18	GP 6.8 Supply Spool Removal.....	6-66
GP 6.3.12 CLOSER TO HOLDER.....	6-18	GP 6.9 Spool Storage.....	6-70
GP 6.3.13 PARTIAL CLOSE Setting.....	6-19	GP 6.10 Internal Inspection.....	6-71
GP 6.3.14 ELEM XFER POS.....	6-19	GP 6.12 Internal Cleaning.....	6-73
GP 6.3.15 ROTATE DELAY Setting.....	6-20	GP 6.13 Base Cleaning.....	6-73
GP 6.3.16 DESKEW ADJUST.....	6-20	GP 6.14 Idler Roller and Idler Springs Inspection.....	6-74
GP 6.3.17 HOLDER.....	6-21	GP 6.14.1 Roller Cleaning.....	6-75
GP 6.3.18 ELEM XFER HALF.....	6-21	GP 6.15 Optical Sensor Cleaning.....	6-75
GP 6.3.19 A4 WIRE OFFSET.....	6-22	GP 6.15.1 Optical Reflectance Sensor Cleaning.....	6-75
GP 6.3.20 HLDR TO CLSR F.....	6-22		
GP 6.3.21 CLSR OPEN DELAY.....	6-23		

GP 6.15.2 Optical Through Beam Sensor Cleaning..... 6-76  
GP 6.15.3 Alignment and Skew Sensor Cleaning..... 6-76  
GP 6.15.4 Spool Detect & Near Empty Sensor Cleaning.. 6-77  
GP 6.15.5 S22 Film Cleaning..... 6-78  
GP 6.16 Bypass Paper Path Inspection and Cleaning..... 6-78  
GP 6.17 Timing Belt Inspection..... 6-79  
GP 6.18 Solenoid Cleaning and Inspection..... 6-79  
GP 6.19 Drawer Slide Rails Cleaning..... 6-80  
GP 6.20 Diverter Solenoid Assembly Inspection..... 6-80  
GP 6.21 List of Sensors..... 6-81  
GP 6.22 Sensor Connections..... 6-82  
GP 6.23 List of Motors..... 6-84  
GP 6.24 Motor Connections..... 6-85  
GP 6.25 List of Solenoids..... 6-86  
GP 6.26 Solenoid Connections..... 6-86  
GP 6.27 Recommended Tool Kit..... 6-87  
GP 6.28 Other Recommended Tools and Supplies..... 6-87  
GP 6.29 Cleaning Materials..... 6-87  
GP 6.30 General Specifications..... 6-88

## GP 6.1 eWire User Interface Options

The User Interface consists of an LCD screen, an Up Arrow button, a Down Arrow button and an Enter Button.

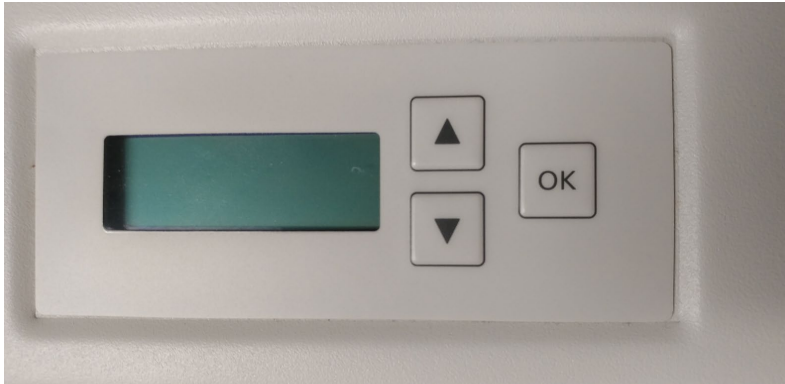

The buttons on the User Interface allow you to change the operation mode, the language, and the units.

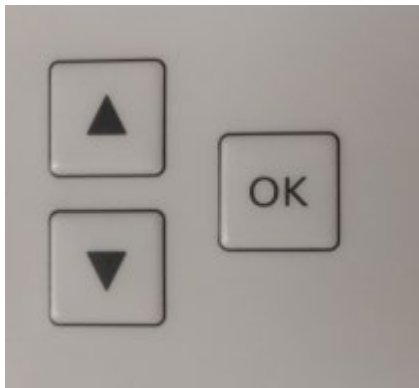

The User Interface displays status messages and fault codes on two rows of text.

## GP 6.1.1 Accessing the User Interface Menu

To change the settings on the User Interface:

From the top level screen, press either the up arrow button or the down arrow button then press the ENTER button to display the SETTINGS/ INFORMATION screen.

<b>SETTINGS</b>	↶	↑
<b>INFORMATION</b>		↓

- The up arrow indicates that there is a menu option above the option displayed.
- The down arrow indicates that there is a menu option below the option displayed.
- The return symbol indicates the option that will open when you press the ENTER button.

To select SETTINGS, press the ENTER button when the return symbol is next to the word Settings.

To select INFORMATION, press the ENTER button when the return symbol is next to the word Information.

<b>READY</b>
<b>TO BIND</b>

In the User Interface, the top row of text displays the status of the eWire (Ready, Close Door). The bottom row of text displays the options selected on the User Interface.



### LCD User Interface Screen Overview

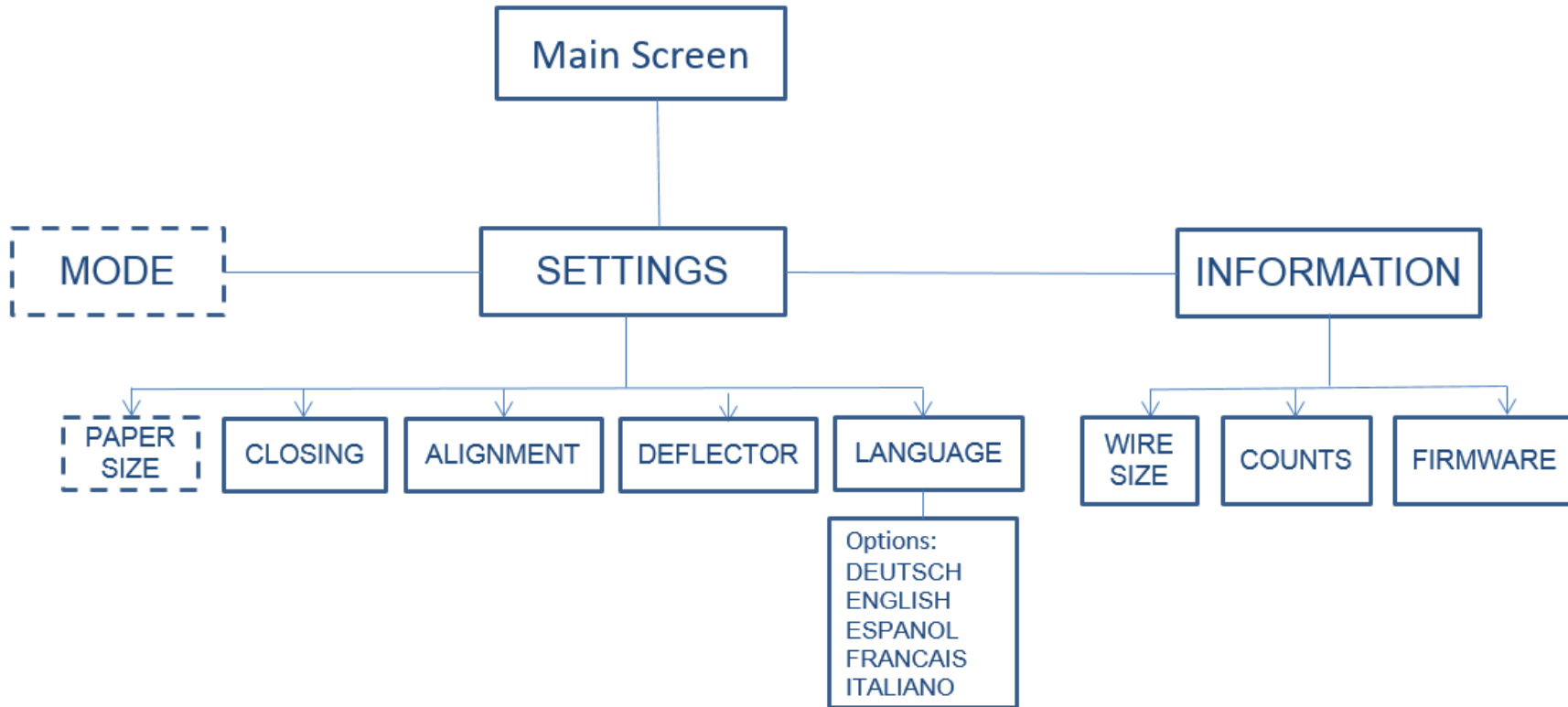

-----  
Dashed lines denote selections only available for printers that do not send paper sizes and bind messages

### ***GP 6.1.3 Accessing the Service Interface Menu***

The Service Interface allows you to:

- Check the operation of the Sensors, Solenoids, and Motors.
- Perform Functional Tests for key modules and processes.
- Change key machine settings
- Perform Firmware Upgrades
- Take log files and backup system settings

When the Service Interface is open, the top row of text and the bottom row of text display the options on the Service User Interface menu.

To enter the Service User Interface:

### LCD Service Interface Screen Overview

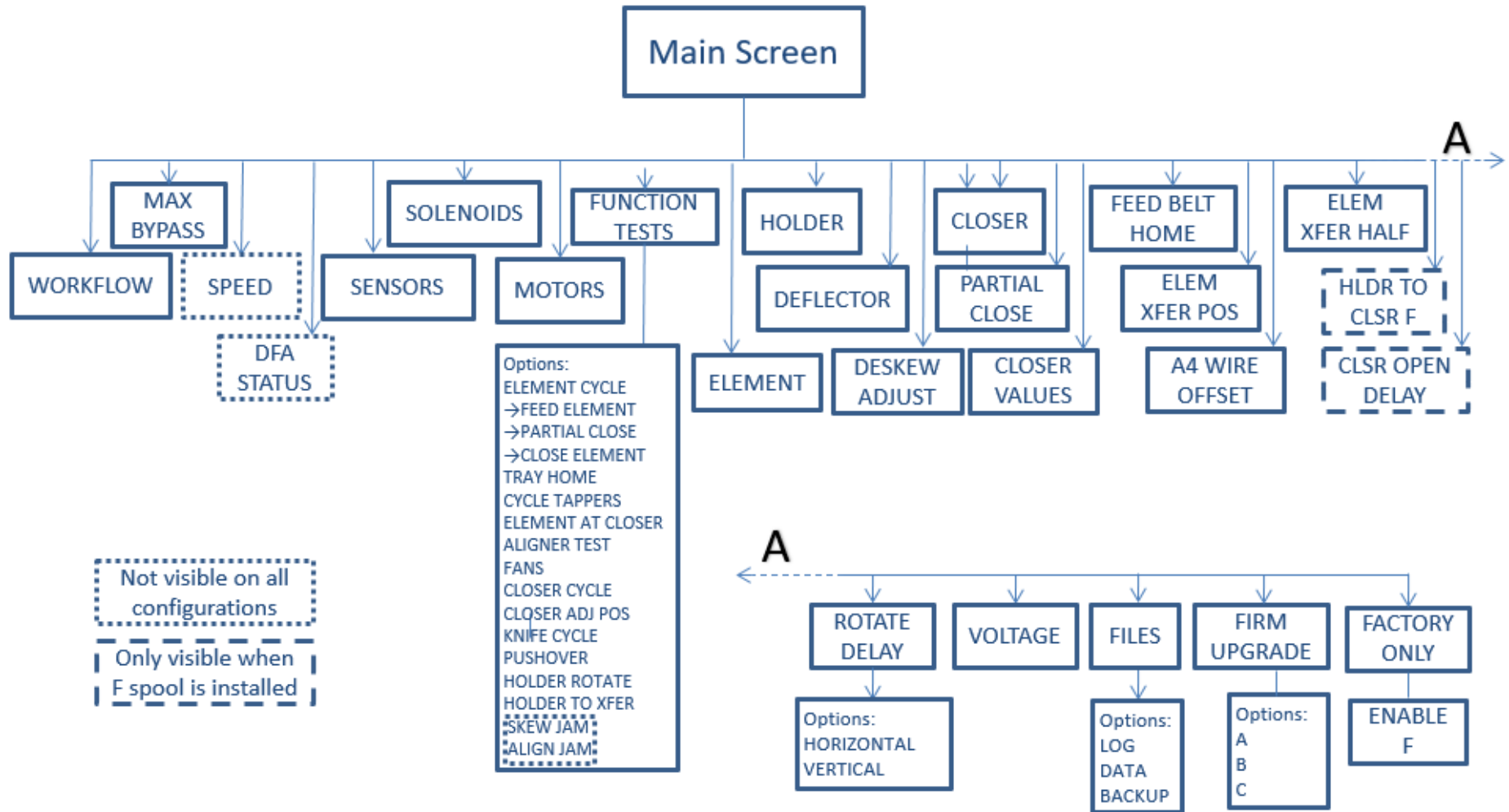

## GP 6.2 User Interface Procedures

The following section describes the options contained in the eWire User Interface. The user interface can be accessed by pressing the up or down arrows on the LCD panel. If jam messages are displayed on the screen then press down to access the user interface

### GP 6.2.1.1 Alignment Setting Adjustment Procedure

Do the following to change the Alignment. Changing the alignment setting will shift the nominal centerline of the sheets toward the front or the rear of the eWire.

From the top level screen, press either the up arrow button or the down arrow button.

READY
TO BIND

This displays the SETTINGS - INFORMATION screen

SETTINGS	←	↑
INFORMATION		↓

Select SETTINGS to enter the setting select menu.

Select ALIGNMENT to enter the alignment adjustment menu.

Press the up arrow or down arrow to change the alignment setting to the desired value (range -2.0 mm to +2.0 mm). Record the initial value so you have a reference point to base future adjustments on.

ALIGNMENT OFFSET	
0.0 mm	←

Press the OK/ENTER button when the desired value is displayed for the Alignment. This will return you to the SETTINGS menu.

Select EXIT and press OK/ENTER to return to the top level menu.

### GP 6.2.1.2 DEFLECTOR Procedure

Refer to GP 6.3.7 for DEFLECTOR Procedure

#### GP 6.2.2 Closing Setting Adjustment Procedure

Do the following to select the desired closer travel. A higher number indicates increased close/crimp of element. A lower number will cause the twin loop element to be crimped less.

Note: Changing the Closing Setting effects only the size that is currently installed. For example, if the A size spool is currently loaded, changing the Closing value will not have any impact on the settings for other sizes.

Note: It is recommended to increment Closing Settings by only one value at a time. Adjusting in larger increments may cause over-adjustment.

From the top level screen, press either the up arrow button or the down arrow button.

READY
TO BIND

This displays the SETTINGS - INFORMATION screen

SETTINGS	←	↑
INFORMATION		↓

Select SETTINGS to enter the setting select menu.

Select CLOSING to enter the closing depth adjustment menu.

Press the up arrow or down arrow to change the closing setting to the desired value (range -5 to +5)

CLOSING	
1	←

Press the OK/ENTER button when the desired value is displayed for the Closing. This will return you to the SETTINGS menu.

Select EXIT and press OK/ENTER to return to the top level menu.

### GP 6.2.3 Paper Size Select Procedure

Do the following to adjust the paper size. This option will not be available on systems that send paper size information in the job. The paper size adjustment allows you to choose between A4 & Letter. Later systems will also allow the selection of A5 and 1/2-Letter sheet sizes.

From the top level screen, press either the up arrow button or the down arrow button.

READY
TO BIND

This displays the SETTINGS - INFORMATION screen

SETTINGS	←	↑
INFORMATION		↓

Select SETTINGS to enter the setting select menu.

Select PAPER SIZE to enter the paper size selection menu.

Press the up arrow or down arrow to select the desired paper size.

PAPER SIZE	
LTR	←

Press the OK/ENTER button when the desired size is displayed. This will return you to the SETTINGS menu.

Select EXIT and press OK/ENTER to return to the top level menu.

### GP 6.2.4 LANGUAGE Selection Procedure

Do the following to select the Language used on the user display.

From the top level screen, press either the up arrow button or the down arrow button.

READY
TO BIND

This displays the SETTINGS - INFORMATION screen

SETTINGS	←	↑
INFORMATION		↓

Select SETTINGS to enter the setting select menu.

Select LANGUAGE to enter the language selection menu.

Press the up arrow or down arrow to select between the available languages.

LANGUAGE	
ESPAÑOL	←

English  
Español  
Français  
Italiano  
Deutsch

Press the OK/ENTER button when the return symbol is next to the language you would like to use. You will automatically return to the SETTINGS menu.

Select EXIT and press OK/ENTER to return to the top level menu.

**GP 6.2.5      *MODE Selection Procedure***

Do the following to select the operation mode for the eWire. This option will not be available on systems that send the mode type information in the job. When eWire is in Bypass mode, sheets will pass through the machine without any action. When eWire is in Bind mode, punched sheets will be diverted into the eWire and bound into books.

From the top level screen, press either the up arrow button or the down arrow button.

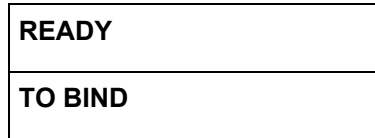

This displays the SETTINGS - INFORMATION screen

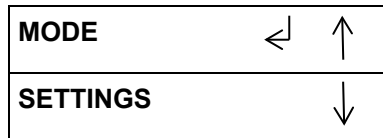

Select MODE to enter the mode select menu.

Press the up and down arrows to toggle between Bypass and Bind modes. Press OK/ENTER when the desired mode of operation is displayed.

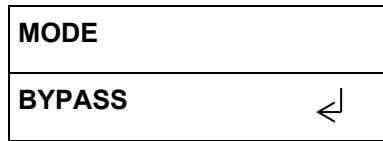

Select EXIT and press OK/ENTER to return to the top level menu.

**GP 6.2.6      *Wire Size Display Procedure***

Do the following to verify the wire size currently selected on the eWire.

From the top level screen,

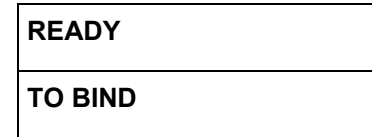

Press either the up arrow button or the down arrow button to display the SETTINGS/ INFORMATION screen.

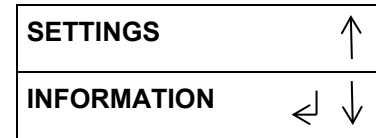

Select INFORMATION to enter the information menu.

Use the up and down arrows to display the WIRE SIZE option within the INFORMATION menu. The currently selected wire size will be displayed on the screen.

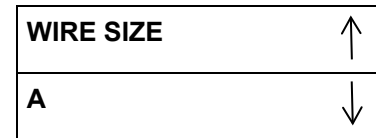

Note the wire size. Press OK/ENTER to return to the previous menu. Select EXIT and press OK/ENTER to return to the top level menu.

**GP 6.2.7 COUNTS Display Procedure**

Do the following to verify the current count of books and sheets for the eWire. Books displays the total number of books that have been produced by the eWire. Sheets displays the total number of sheets of paper that have passed through the eWire.

From the top level screen,

<b>READY</b>
<b>TO BIND</b>

Press either the up arrow button or the down arrow button to display the SETTINGS/ INFORMATION screen.

<b>SETTINGS</b>	↑
<b>INFORMATION</b>	← ↓

Select INFORMATION to enter the information menu.

Use the up and down arrows to display the COUNTS option within the INFORMATION menu. The current count of BOOKS and SHEETS will be displayed.

<b>BINDS=</b>	↑
<b>SHTS=</b>	↓

Record the number of Books and Sheets.

Press OK/ENTER to return to the previous menu.

Select EXIT and press OK/ENTER to return to the top level menu.

**GP 6.2.8 FIRMWARE Display Procedure**

The Firmware feature identifies the level of the firmware currently installed to the eWire.

From the top level screen,

<b>READY</b>
<b>SINGLE PUNCH</b>

Press either the up arrow button or the down arrow button to display the SETTINGS/INFORMATION screen.

<b>SETTINGS</b>	↑
<b>INFORMATION</b>	← ↓

Select INFORMATION to enter the information menu.

Use the up and down arrows to display the FIRMWARE option within the INFORMATION menu. The currently installed firmware will be displayed on the screen.

<b>A=00.00 B=00.00</b>
<b>C=00.00</b>

Note the version level of the firmware installed on the A, B, and C firmware.

Press the OK/ENTER button to return to the previous menu

Select EXIT and press OK/ENTER to return to the top level menu.

### GP 6.3 Service Interface Procedures

The following section describes the options available via the eWire service menu. The options in this section should only be changed by qualified service technicians during a service call.

#### GP 6.3.1 SENSOR Check Procedure

A sensor can fail in two modes:

- **Failed in High state:** Machine thinks the sensor is unblocked even when a sensor flag or sheet is present. In this mode, the LCD will always show "0" for that sensor, and will not go to "1" when a sheet is present.
- **Failed in Low state:** The opposite of the above. The Sensor will show as blocked even when there is no object blocking the sensor.

It is less likely for a sensor to fail in a Low state. Therefore it is more likely that the Sensor will fail to see its flag than the reverse. If the Sensor shows "1" and will not go to "0" it is more likely that there is something blocking the sensor, like debris or a scrap of paper. [GP 6.29 Cleaning Materials](#)

#### Procedure

Do the following to check the status of any of the sensors.

The Sensors feature allows you to view the state of each of the Sensors located throughout the eWire.

The information contained in this section of the manual will help you to identify and test each of the Sensors in the eWire.

Cover the sensor to check if the sensor status changes from "0" to "1".

- 0 means the sensor is open.**
- 1 means the sensor is covered.**

**Sensors voltages can be checked using the test points on the control boards, refer to GP 6.22**

Do the following steps to check the sensors:

1. Enter Service Mode by following the procedure described in [GP 6.1.3](#)
2. In service mode, scroll down to select SENSORS from the menu.
3. Press the **OK/ENTER** button when the return symbol is next to the word SENSORS to display the first SENSORS screen.

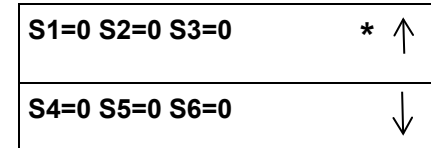

4. Press the down arrow to scroll through the available Sensors until you locate the Sensor you wish to test.
5. Locate the Sensor on the machine. Refer to [GP 6.4](#) for help in locating a specific Sensor.
6. Verify that the Sensor reads "0" when unblocked and "1" when blocked. You can do this by manually covering the sensor with a piece of paper or other object.
7. If the Sensor does not behave as expected, refer to the troubleshooting steps in [GP 6.4](#) Sensor Checks to troubleshoot the Sensor.
8. When you have completed the Sensor check, scroll down to PREVIOUS MENU or EXIT to leave Sensor mode.
9. Select EXIT and press OK/ENTER to return to the top level menu.

When all the doors and covers are closed and no jams are present the status of each sensor should be as outlined in the table below.

S#	State	S#	State	S#	State	S#	State	S#	State
S1	0	S12	0	S24	1	S34	1	S44	0
S2	0	S13	0	S25	0	S35	0	S45	0
S3	0	S15	0	S26	1	S36	1	S46	1
S4	0	S16	0	S27	1	S37	0	S47	1
S5	0	S18	1	S28	1	S38	0	S48	0
S6	0	S19	1	S29	1	S39	0	S49	0
S7	0	S20	1	S30	0	S40	0	S50	1
S8	0	S21	1	S31	0	S41	1		
S9	0	S22	1	S32	1	S42	1		
S10	0	S23	0	S33	0	S43	0		



### GP 6.3.2 SOLENOIDS Procedure

The Solenoid feature allows you to test the operation of each of the solenoids in the machine.

**NOTE: Door needs to be closed or Interlock Cheater inserted to do this.**

Enter Service Mode by following the procedure described in [GP 6.1.3](#). Press the down arrow until the return symbol is next to the words SOLENOIDS. Press OK/ENTER.

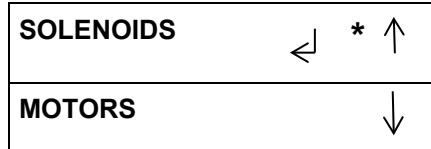

Press the down arrow to scroll through the solenoid options.

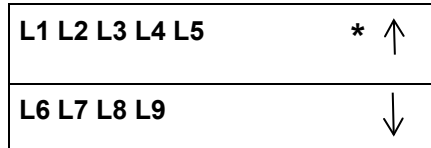

Press the OK/ENTER button to turn the selected solenoid on. You should hear the Solenoid click, and see the Solenoid actuate if it is visible. Repeat as needed to check the other Solenoids. If a Solenoid does not operate do [GP 6.18](#) Solenoid Cleaning and Inspection, and repeat steps 1-5. Refer to [GP 6.6](#) for additional info regarding locating and testing the various Solenoids in the eWire. Select BACK to return to the Service Mode menu. Select EXIT to return to the top level screen.

### GP 6.3.3 MOTORS Procedure

The Motors feature allows you to test the operation of selected Motors throughout the eWire. Do the following to check the Motors.

**NOTE: Door needs to be closed or Interlock Cheater inserted to do this.**

Follow the procedure described in [GP 6.1.3](#) to enter Service Mode. Press the down arrow until the return symbol is next to the word MOTORS.

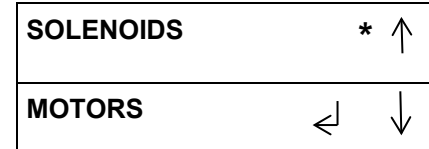

Press the OK/ENTER button to display the display the first MOTORS screen.

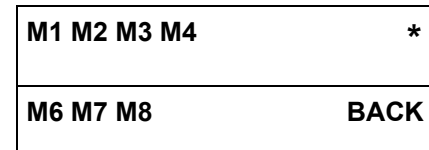

Press the down arrow to scroll through the motors. The selected motor will flash on the LCD screen. Press the OK/ENTER button to turn the selected motor on. You should hear the motor running. The motor will run continuously until it is turned off. Press the OK/ENTER button again to turn the selected motor off. Repeat as needed to check the other Motors. Refer to [GP 6.5](#) for additional info regarding motor checks, and for help locating the appropriate motor within the eWire. Press the up or down arrow to highlight the BACK option. Press the OK/ENTER button to display the SOLENOIDS / MOTORS menu. Press the up arrow to display the EXIT option. Press OK/ENTER to return to the top level screen.

#### GP 6.3.4 FUNCTION TESTS Procedure

Do the following to perform Functional Tests. The Functional Test feature allows you to test the operation of various sub-assemblies and machine operations within the eWire.

Enter Service Mode by following the procedure described in [GP 6.1.3](#)

Press the down arrow until the return symbol is next to the words FUNCTION TESTS. Press OK/ENTER.

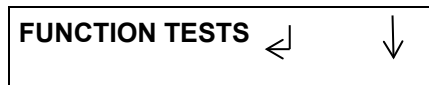

**NOTE: Use extreme caution if running any Functional Tests with Interlock Cheaters installed. Injury or machine damage could occur when running the functional tests. Keep hands free of all moving parts while performing this procedure.**

After the Functional Test cycle is completed it will stop automatically.

If necessary, press the OK/ENTER button again to repeat the Functional Test.

Use the arrows to scroll down to Previous Menu to return to the Functional Test Screen

Use the arrows to scroll down to Exit to exit Service Mode and return to the top level screen.

The following Function Tests are Available through Service Menu:

- **Element Cycle:** This opens a sub menu containing the following function tests relating to the Element Feeder
  - **Feed Element:** The Element Feeder will feed and cut enough element to produce one book of the size selected. It will then transfer the element to Holder and move it to Stack Position. If the feeder drawer is out when the function is run then the element will be dropped by the expanding T to the right of the spool
  - **Partial Close:** After performing the Feed Element function, this will bring the closer to the holder, perform a partial close of the element, and remain at the holder.
  - **Full Close:** After performing the Feed Element function, this will bring the closer to the holder, close the element, return the closer home, and eject the element into the Book Drawer Tray.
  - **Feed/Close Auto:** This will run the element cycle continuously with or without a spool present. This is used in manufacturing setup.

- **Tray Home:** Will home the Book Drawer Tray. If the tray is already in the up position, it will move down slightly and then return to home.
- **Cycle Tappers:** Front and Rear Tapper Modules will cycle one time.
- **Element at Closer:** Holder and Closer Modules will return to their home positions.
- **Aligner Test:** The aligner motor will cycle back and forward.
- **Fans:** The vacuum stacker fan will run continuously.
- **Closer Cycle:** The closer jaws will close and open once.
- **Closer Adj Pos:** The closer will rotate to make the timing fastener accessible.
- **Knife Cycle:** The Knife will close and open once. Use extreme caution when running this with interlock cheaters installed and make sure hands are clear of the knife blade.
- **Pushover:** The Pushover module will cycle out or home as selected by the user.
- **Holder Rotates:** Holder will rotate horizontally or vertically as selected by the user.
- **Holder to Xfer:** Holder will move forward to mate with the Element Feeder.
- **Transfer Setup:** An element will be fed, cut and picked up by the expanding-T. It will then move over close to the holder by pressing the arrow buttons. This enables checking the alignment of the element to the holder.

### GP 6.3.5 FIRMWARE UPGRADE Procedure

form the following steps to upgrade the firmware.

1. Open the Element Feeder Door of eWire before performing the Firmware upgrade procedure. It is required to have a door open during the process to prevent the system from accidentally starting a print job or from entering a mode that may interfere with the Firmware upgrade process.

2. Remove (2) M4 screws and the USB port cover from the back of the machine.

3. Save the firmware file you want to upload to the USB flash drive provided.

**IMPORTANT NOTE:** Only one file should be present for each of Firmware A, B, and C in the root folder of the USB flash drive. Other files can be moved to folders.

4. Enter Service Mode by following the procedure described in [GP 6.1.3](#)

5. Insert the USB Flash drive (FAT32 Format) with the firmware file you want to upload.

6. Press the OK/ENTER button when the return symbol is next to the words FIRMWARE UPGRADE to display the FIRMWARE UPGRADE screen.

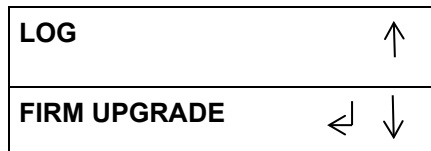

7. Press the down arrow to scroll through the Firmware Upgrade options.

- A – Select this to update the Main Board Transport firmware.
- B – Select this to update the B Board binding firmware.
- C – Select this to update the Main Board Comm firmware.

8. Press the OK/ENTER button when the return symbol is next to the Board that you want to upgrade the firmware for.

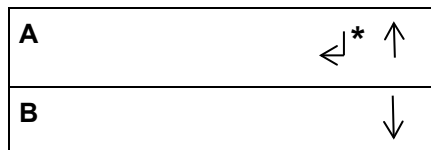

9. When update is complete for the A or B firmware, the system will display the screen shown below. Press OK/ENTER to return to the

Firmware Upgrade Menu and select the next firmware to upgrade. When update is complete for the C firmware, you will return automatically to the previous screen.

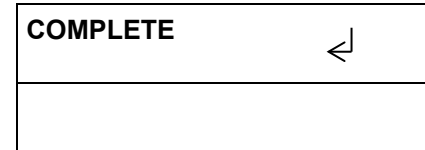

10. Press OK/ENTER to return to the Main Screen.

11. Install the Cover for USB port and tighten the Screws (2).

12. Power down the system. Wait 10 seconds, and then switch the system back on again. Do [GP 6.2.8](#) to check the firmware, and verify the Firmware revision is correct.

**GP 6.3.6 ELEMENT SETTINGS Procedure**

The Element Settings option allows the user to change the position of the “Holder at Stack” and “Holder at Closer” positions. Changing this value will cause the travel of the Holder to be slightly more or less at the position selected.

Enter Service Mode by following the procedure described in [GP 6.1.3](#)  
Press the down arrow until the return symbol is next to the words ELEMENT. Press OK/ENTER.



Note the current value before making any changes, so you have a reference point to return to.

The stack position can be changed on a range of -50 to +50

Any changes made to STACK POSITION will apply only to the selected element size. The settings will be remembered when running that size in the future, but other sizes will not be affected.

Press OK/ENTER to save the selected value. You will return to the service menu.

**GP 6.3.7 DEFLECTOR Procedure**

The Deflector position setting will change the timing offset for the Deflector module. The default value is 0. The timing offset relates to the amount of time that passes from the Deflector Sensor detecting a sheet to the deflector solenoids firing.

Enter Service Mode by following the procedure described in [GP 6.1.3](#)  
Press the down arrow until the return symbol is next to the words DEFLECTOR. Press OK/ENTER.



Note the current value before making any changes, so you have a reference point to return to.

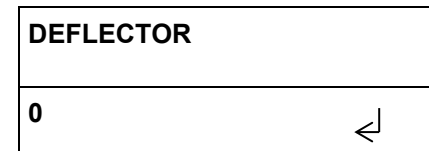

The deflector timing can be changed on a range of -5.0mm to +5.0mm. Press OK/ENTER when the desired value is flashing to save the Deflector settings. You will return automatically to the service menu.

Any changes made to the Deflector Timing values will apply only to the currently installed element size. The settings will be remembered when the same size is installed again, but other sizes will not be affected. If no spool is currently installed, an error message will occur.

### GP 6.3.8 FILES Procedure

The Log procedure allows you to save information about machine settings and past performance to a USB drive.

Enter Service Mode by following the procedure described in [GP 6.1.3](#)

Remove the Screws and remove the USB cover to access the USB port on the rear of the eWire. Insert a USB drive to the port.

#### Backup/Restore Setting

Follow these steps to save the machine data to a USB so that they can later be restored. These settings are set in the factory and updated whenever an adjustment is performed on the eWire. Loss of these settings will result in the eWire not functioning.

Press the down arrow until the return symbol is next to the words FILES. Press OK/ENTER.

DATA	↵ ↓
BACKUP	

Scroll down and select BACKUP, the option to LOAD or SAVE will appear. When backing up the old board, select SAVE, when loading a backup from the USB onto a new board, select LOAD

LOAD	↵
SAVE	

If this back up is ever lost, the factory back up can be restored to the machine, but any adjustment will have been lost. Take the USB from the rear of the eWire and open it on a computer. Make a copy of FACTORY\_EEPROM\_SN#####.BAK and rename this copy C\_EEPROM.BAK. Return the USB to the back of the machine and perform the steps above to load the setting.

#### Retrieve Log Data

Press the down arrow until the return symbol is next to the words FILES. Press OK/ENTER.

LOG	↵ ↓
DATA	

Select LOG to save the current log file to a USB storage device located on the back panel. The file name will be LOG0001.txt, and increment each time the log is saved.

SAVE TO USB	↵
PREVIOUS MENU	

Press Enter to save the current Log File to your USB storage device. You will receive a message showing the log has been saved and the name of the Log File. Press OK/ENTER to return to the service menu.

#### Retrieve Setting Data

The settings can be retrieved in a readable text file.

Press the down arrow until the return symbol is next to the words FILES. Press OK/ENTER.

LOG	↵ ↓
DATA	

Select DATA to save machine settings to USB. It is recommended to save settings each time a change is made. Select SAVE TO USB and press ENTER to save current machine settings

### GP 6.3.9 VOLTAGE

The Voltage option in the service menu will display information on the voltage in the eWire.

Using the procedure described in [GP 6.1.3](#), enter Service mode.  
Use the up and down arrows to scroll down to the Voltage option.

- 24:** Status of the 24v coming supplied from the power supply
- 24i:** Status of the 24v supplied to eWire through the interlocks
- 5:** Status of the 5v power supplied to the eWire
- 3.3:** Status of the 3.3v power supplied to the eWire

### GP 6.3.10 MAX BYPASS Setting

Do the following to set the maximum bypass sheet length through eWire.

Using the procedure described in [GP 6.1.3](#), enter Service mode.  
Use the up and down arrows to scroll down to the MAX BYPASS option.

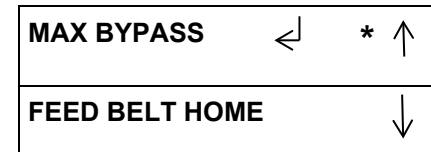

The below screen will appear

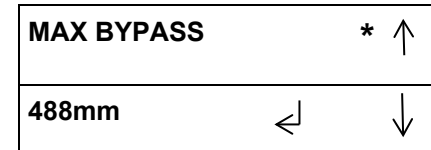

762mm is the default Max Bypass setting. To reduce the Max Bypass setting, press the down arrow to the desired setting, and then press OK. You will return automatically to the service menu.

The Max Bypass setting will increase the bypass jam timer so all sheets will take longer to trigger a jam. These could result in causing more sheets to be fed when jams with smaller sheets occur.

### GP 6.3.11 FEED BELT HOME Setting

The Feed Belt Home setting will allow the operator to change the position the Element Feeder Belt reaches when it is in home position.

Using the procedure described in [GP 6.1.3](#), enter Service mode.

Use the up and down arrows to scroll down to the FEED BELT HOME option.

FEED BELT HOME	← * ↑
LOG	↓

The below screen will appear

FEED BELT HOME	* ↑
0	← ↓

0 is the default setting. The Feed Belt Home value can be adjusted on a range of -50 to +50. When the desired value has been selected, press OK/ENTER to return to the service menu.

Select EXIT and press OK/ENTER to return to the top level menu.

### GP 6.3.12 CLOSER TO HOLDER

The Closer to Holder setting will allow the operator to change the position the closer stops at when moving to partial close the element on the holder.

Using the procedure described in [GP 6.1.3](#), enter Service mode.

Use the up and down arrows to scroll down to the CLOSER TO HOLDER option.

CLOSER TO HOLDER	← * ↑
------------------	-------

The below screen will appear

CLOSER TO HOLDER	* ↑
0	← ↓

0 is the default setting. The Closer to Holder value can be adjusted on a range of -256 to +256. When the desired value has been selected, press OK/ENTER to return to the service menu. Increasing the value will move the closer further to the left (towards the element). Decreasing the value will move the closer further to the right or away from the element.

Select EXIT and press OK/ENTER to return to the top level menu.

### GP 6.3.13 PARTIAL CLOSE Setting

The Partial Close setting will allow the operator to change the amount the closer closes down on the unbound element prior to binding

Using the procedure described in [GP 6.1.3](#), enter Service mode.  
Use the up and down arrows to scroll down to the PARTIAL CLOSE

PARTIAL CLOSE	←	*	↑
---------------	---	---	---

The below screen will appear

PARTIAL CLOSE	*	↑
0	←	↓

0 is the default setting. The Partial Close value can be adjusted on a range of -10 to +10. When the desired value has been selected, press OK/ENTER to return to the service menu.

Select EXIT and press OK/ENTER to return to the top level menu

### GP 6.3.14 ELEM XFER POS

The Element Transfer Position setting will allow the operator to change the position of the element on the Element Feeder Belt when it is transferred to the holder for A4 and letter sized elements.

**NOTE: This setting only affects A4 and letter. See [GP 6.3.18](#) to adjust the transfer position for A5 and statement size elements.**

Using the procedure described in [GP 6.1.3](#), enter Service mode.  
Use the up and down arrows to scroll down to the ELEM XFER POS

ELEM XFER POS	←	*	↑
---------------	---	---	---

The below screen will appear

ELEM XFER POS	*	↑
0	←	↓

0 is the default setting. The Element Transfer Position can be adjusted on a range of -50 to +50. When the desired value has been selected, press OK/ENTER to return to the service menu.

Select EXIT and press OK/ENTER to return to the top level menu



### GP 6.3.15 ROTATE DELAY Setting

The Rotate Delay setting will allow the operator to change the position of the holder rotate by delaying the stop of the holder a set amount of time.

Using the procedure described in [GP 6.1.3](#), enter Service mode.

Use the up and down arrows to scroll down to the ROTATE DELAY option.



The below screen will appear

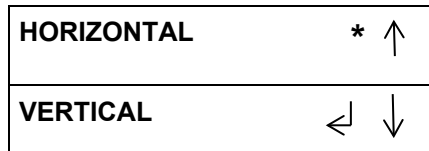

For both the horizontal and vertical, 0 is the default setting. The Rotate Delay for both settings value can be adjusted on a range of 0 to +100.

When the desired value has been selected, press OK/ENTER to return to the service menu.

Select EXIT and press OK/ENTER to return to the top level menu.

### GP 6.3.16 DESKEW ADJUST

The DESKEW ADJUST setting will allow the operator to change the amount the steering rollers corrects for skewed sheets entering the eWire. Using the procedure described in [GP 6.1.3](#), enter Service mode.

Use the up and down arrows to scroll down to the DESKEW ADJUST

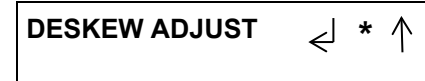

The below screen will appear

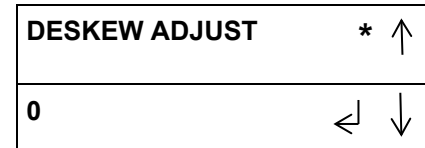

0 is the default setting. The Deskew Adjust value can be adjusted on a range of -20 to +20. When the desired value has been selected, press OK/ENTER to return to the service menu.

Select EXIT and press OK/ENTER to return to the top level menu

### GP 6.3.17 HOLDER

The holder transfer position setting will allow the service technician to change the position of the holder as it comes to mate with the feeder.

Using the procedure described in [GP 6.1.3](#), enter Service mode.

Use the up and down arrows to scroll down to the HOLDER menu.

HOLDER	← * ↑
--------	-------

The below screen will appear

HOLDER TO XFER	* ↑
60	← ↓

60 is the default setting. The HOLDER TO XFER value can be adjusted on a range of -100 to +100. When the desired value has been selected, press OK/ENTER to return to the service menu.

Select EXIT and press OK/ENTER to return to the top level menu.

### GP 6.3.18 ELEM XFER HALF

The Element Transfer Position Half setting will allow the operator to change the position of the element on the Element Feeder Belt when it is transferred to the holder for A5 and statement sized elements.

**NOTE: This setting only affects A5 and statement. See [GP 6.3.14](#) to adjust the transfer position for A4 and letter size elements.**

Using the procedure described in [GP 6.1.3](#), enter Service mode.

Use the up and down arrows to scroll down to the ELEM XFER POS

ELEM XFER HALF	← * ↑
----------------	-------

The below screen will appear

ELEM XFER HALF	* ↑
0	← ↓

0 is the default setting. The Element Transfer Position Half can be adjusted on a range of -50 to +50. When the desired value has been selected, press OK/ENTER to return to the service menu.

Select EXIT and press OK/ENTER to return to the top level menu

### GP 6.3.19 A4 WIRE OFFSET

The A4 Wire Offset is an offset applied to the Element Transfer Position to allow A4 elements to transfer more accurately.

**NOTE: This setting is set by the factory and should not be adjusted unless instructed to do so during an escalation.**

If adjustments are required to the Element Transfer Position of A4 or letter elements, go to [GP 6.3.14](#) and adjust the Element Transfer Position

### GP 6.3.20 HLDR TO CLSR F

The Holder to Closer F setting adjusts how far the holder moves when mating with the closer while binding an F size element. Increasing this value will result in the element being lower when it meets the closer, increasing it will raise the position of the element when they meet. This setting does not affect the holder behavior when non-F size spools are installed in the machine.

**NOTE: This setting is only visible when an F size spool is installed in the eWire.**

Using the procedure described in [GP 6.1.3](#), enter Service mode.

Use the up and down arrows to scroll down to the HLDR TO CLSR F



The below screen will appear

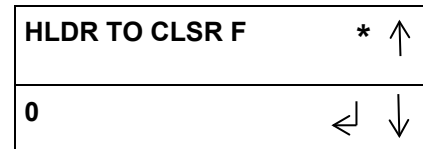

0 is the default setting. Holder to Closer F can be adjusted on a range of 0 to +50. When the desired value has been selected, press OK/ENTER to return to the service menu.

Select EXIT and press OK/ENTER to return to the top level menu

### GP 6.3.21 CLSR OPEN DELAY

The Closer Full Open Delay setting adjusts how wide the closer jaws open when homing while binding an F size element. This setting does not affect the closer homing behavior when a non-F size spool is installed in the machine.

**NOTE: This setting is only visible when an F size spool is installed in the eWire.**

Using the procedure described in [GP 6.1.3](#), enter Service mode.

Use the up and down arrows to scroll down to the CLSR OPEN DELAY

CLSR OPEN DELAY	←	*	↑
-----------------	---	---	---

The below screen will appear

CLSR OPEN DELAY	*	↑
0	←	↓

0 is the default setting. Closer Full Open Delay can be adjusted on a range of 0 to +500. When the desired value has been selected, press OK/ENTER to return to the service menu.

Select EXIT and press OK/ENTER to return to the top level menu

### GP 6.3.22 Factory Only

This contains settings that are set by the factory and should not be modified unless directed to during an escalation.

To access these settings, Enter Service Mode by following the procedure described in [GP 6.1.3](#)

Press the down arrow until the return symbol is next to the words FACTORY ONLY. Press OK/ENTER.

FACTORY ONLY	←	↓
--------------	---	---

The following settings are available through this menu:

### GP 6.4 Check Sensors

Use the information in this section to locate the appropriate sensor(s) on the eWire. Once you have located the sensor, follow [GP 6.3.1](#) to verify the function of the sensor. If the sensor does not operate as expected, follow the troubleshooting steps located in this section to fix the faulty sensor.

#### GP 6.4.1 Check S1-S5, S16, S43, S45

Use the information in this section to locate the appropriate sensor(s) on the eWire. Once you have located the sensor, follow [GP 6.3.1](#) to verify the function of the sensor. If the sensor does not operate as expected, follow the troubleshooting steps located in this section to fix the faulty sensor.

#### Locate sensors S1, S4, S5, and S16:

- Raise the Top Cover.
- The sensor windows are located on the Upper Bypass, oriented toward the paper path.
- Sensors S1, S4, S5, and S16 can be blocked manually by using a piece of paper or other solid object.

Sensors S1, S4, S5 and S16 are on the Upper Bypass Panel (PL 5.2).

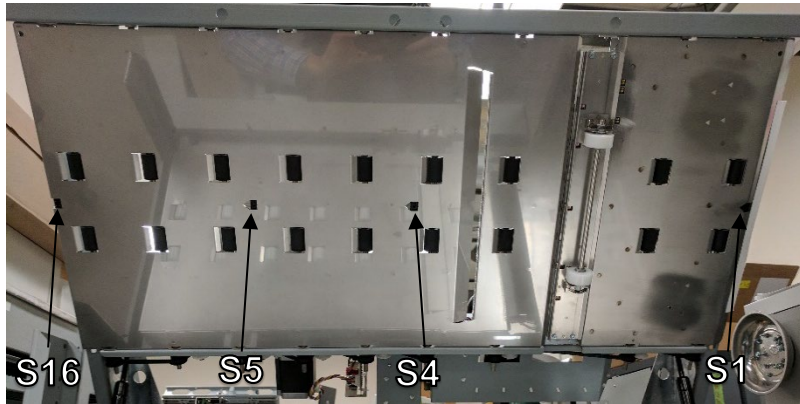

#### Locate sensors S2 and S3:

- Raise the Top Cover and the Lower Bypass panel.
- If necessary, manually slide the closer assembly all the way to the right of the machine.
- Sensors S2 and S3 can be manually blocked by using a piece of paper or other solid object.

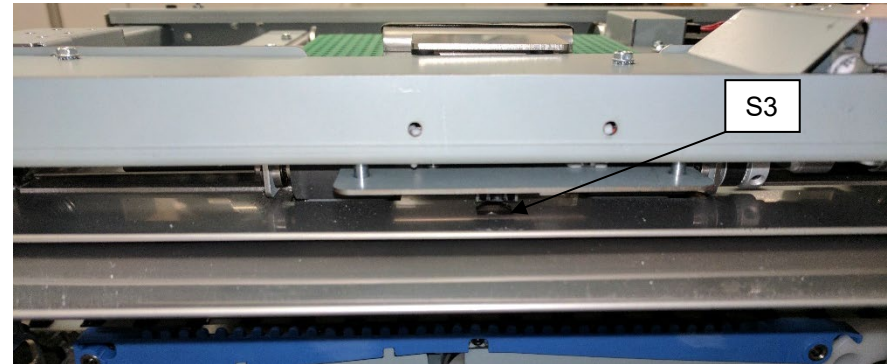

Sensor S2 is located on the lower bypass panel. Sensor S3 is located on the Deflector Module (PL 5.16).

### Locate sensors S43 and S45:

- Slide the book drawer all the way out of the machine.
- Remove any books or paper from the book drawer tray.
- Sensors can be manually blocked using a piece of paper or other object.



Sensors S43 and S45 are on the Book Drawer (PL 5.23)

### Check Sensors Procedure (S1, S2, S3, S4, S5, S16, S43, and S45):

1. Do GP 6.3.1 [SENSORS Procedure](#). Check to make sure the sensor shows “0” on the LCD when uncovered and “1” when covered. If the sensor shows “1” when uncovered, clean the sensor. Also check if there is any obstruction in the sensor window.

**All sensors show “0” when uncovered and “1” when covered**

**Yes-** Return to the RTP that directed you here.

**No-**Go to Step 2

2. Make sure the sensor wire is connected securely at the Sensor and at the Main Control Board (PL 5.27). Do REP 1.5 to remove the Rear Cover to gain access to the connector at the Control Board. Refer to [GP 6.22](#) and Section 7 for additional info regarding the connector locations.

**All the connections are made securely**

**Yes-** Go to Step 3

**No-** Make the connection and repeat Step 1.

3. Replace the Sensor with a new one (alternatively, swap the sensor in the faulty position with a sensor from a different good position to check if it is a bad sensor).

**Replacing the sensor corrects the issue**

**Yes-**Install the new sensor and return to normal operation

**No-**Go to Step 4

4. Visually inspect the Cable from the sensor all the way to the Control Board (PL 5.27). If the Cable is damaged, replace the Cable. Refer to [GP 6.22](#) to identify all cables used with the sensor.

**Sensor cable looks okay**

**Yes-**Go to Step 5

**No-**Go to Step 6

5. Do GP 6.3.5 [FIRMWARE UPGRADE Procedure](#) to Re-flash the firmware for the eWire.

**Re-flashing firmware clears the fault**

**Yes-** Resume normal operation

**No-** Go to Step 6

6. Replace the Sensor Cable(s). Remove the faulty cable from the sensor by releasing the required cable clamps. Replace with a new cable. Refer to GP 6.22 to identify all required cables.

**Replacing the sensor cable(s) corrects the issue**

**Yes-** Resume normal operation

**No-** Go to Step 7

7. Do REP 11.1 or REP 11.2 to replace the Main Control Board (PL 5.27).

**This clears the fault**

**Yes-** Resume normal operation

**No-** Escalate to second level

**GP 6.4.2 Check S6-S10, S12, S13, and S15**

Use the information in this section to locate the appropriate sensor(s) on the eWire. Once you have located the sensor, follow [GP 6.3.1](#) to verify the function of the sensor. If the sensor does not operate as expected, follow the troubleshooting steps located in this section to fix the faulty sensor.

**Locate Sensors S12, S13, and S15:**

- **Raise the Top Cover.**
- **Locate the Alignment Sensor Board openings on the Upper Bypass panel frame.**
- **The sensors are mounted on a common Board, but can be checked individually.**
- **Sensors S11 and S14 are located on the Alignment Sensor Board, but are not used with eWire.**

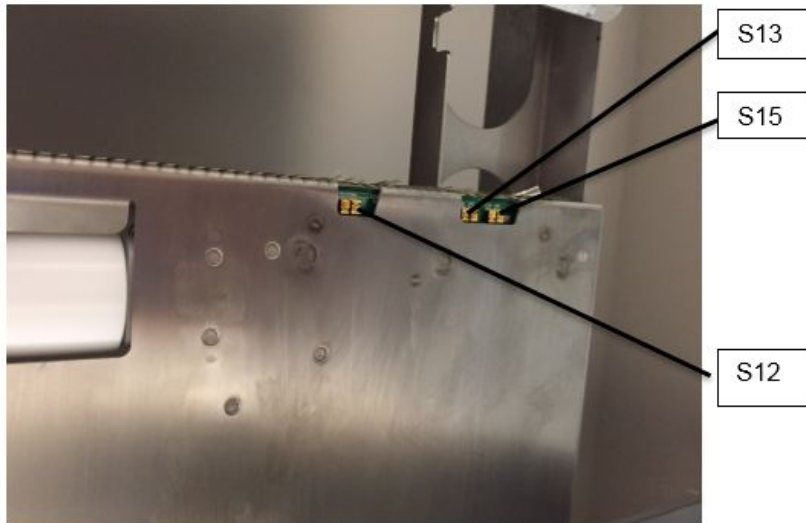

**Sensors S12, S13, and S15 are located on the Alignment Sensor Board**

**Locate Sensors S6, S7, S8, S9, and S10:**

- **Raise the Top Cover**
- **Locate the Skew Sensor Board on the surface of the Alignment Carriage.**
- **Sensors S6-S10 can be checked by sliding a piece of paper into the opening below the Skew Sensor PCB**

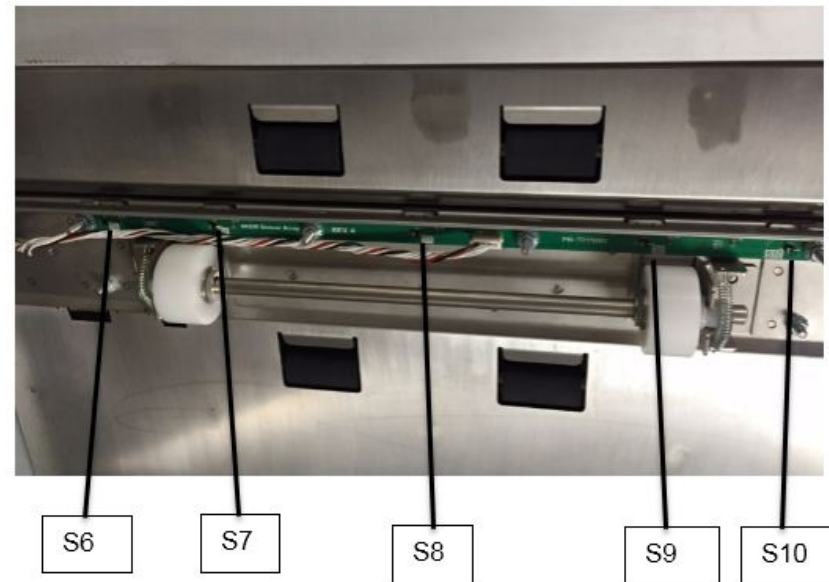

Sensors S6, S7, S8, S9, and S10 are on the Skew Sensor Board

### Check Sensors Procedure (S6 – S10, S12 – S15):

1. Do GP 6.3.1 [SENSORS Procedure](#). Check to make sure all sensors show “0” on the LCD when uncovered and “1” when covered.

If any sensor shows “1” when uncovered, clean that sensor. Also check if there is any obstruction in the sensor window.

**All sensors show “0” when uncovered and “1” when covered**

**Yes-** Return to the RTP that directed you here.

**No-**Go to Step 2

2. Make sure the sensor cable is connected securely at the Sensor and at the Main Control Board (PL 5.27). Do REP 1.5 to remove the Rear Cover to gain access to the connector at the Control Board. Refer to [GP 6.22](#) and Section 7 for additional info regarding the connector locations.

**All the connections are made securely**

**Yes-** Go to Step 3

**No-** Make the connection and repeat Step 1.

3. Light from sensor components can be viewed with a cell phone camera, if the sensor is working you will be able to see a bright light. Alternately a small mirror can be used. Use this procedure to check that each sensor is emitting a beam of light during operation.

**CAUTION: Sensor emits High Intensity narrow angle Infrared beam (940nm). It is invisible to naked eye, avoid looking directly at the sensor when the machine is powered ON. See Section 0, page ix for other languages.**

**There is no light from any of the sensors on the Sensor Board**

**Yes-** Go to Step 4

**There is no light from some of the sensors on the Sensor Board**

**Yes-** Go to Step 5

**There is a bright light from all the sensors**

**Yes-** Go to Step 6

4. Replace the sensor board- REP 2.14 for S6-S10 or REP 2.15 for S12-S15

**This clears the fault**

**Yes-** Resume normal operation

**No-** Go to Step 5

5. Replace the sensor cable(s). Refer to [GP 6.22](#) for cable part number(s) and location.

**This clears the fault**

**Yes-** Resume normal operation

**No-** Go to Step 6

6. Do GP [6.3.5 FIRMWARE UPGRADE Procedure](#) to Re-flash the firmware for the eWire.

**This clears the fault**

**Yes-** Resume normal operation

**No-** Go to Step 7

7. Do REP 11.1 to replace the Main Control Board (PL 5.27).

**This clears the fault**

**Yes-** Resume normal operation

**No-** Escalate to second level



### GP 6.4.3 Check S18-S20, S24, S31-S41, S46-S49

#### Locate Sensor S18:

- Raise the top Cover.
- If Necessary, do REP 1.8 to remove the Front Cover.
- Locate the Front Tapper 7716863
- Rotate the tapper assembly manually so that the encoder wheel rotates within the sensor. The sensor will become unblocked when the encoder window is centered within the sensor detect area.

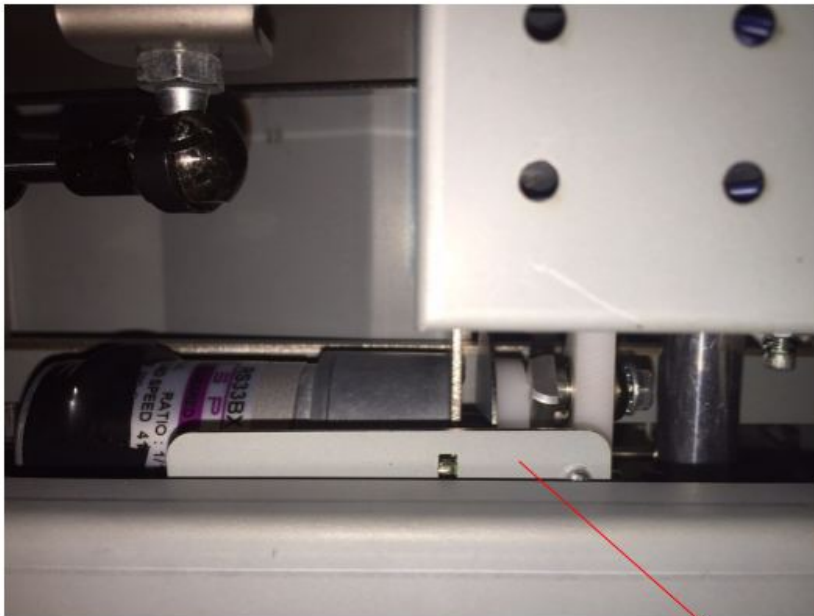

S18

S18 is located in the front tapper module

#### Locate Sensor S19:

- Raise the top Cover.
- Locate the Rear Tapper 7716874
- Rotate the tapper assembly manually so that the sensor is blocked or unblocked. The sensor will become unblocked when the encoder window is centered within the sensor detect area.

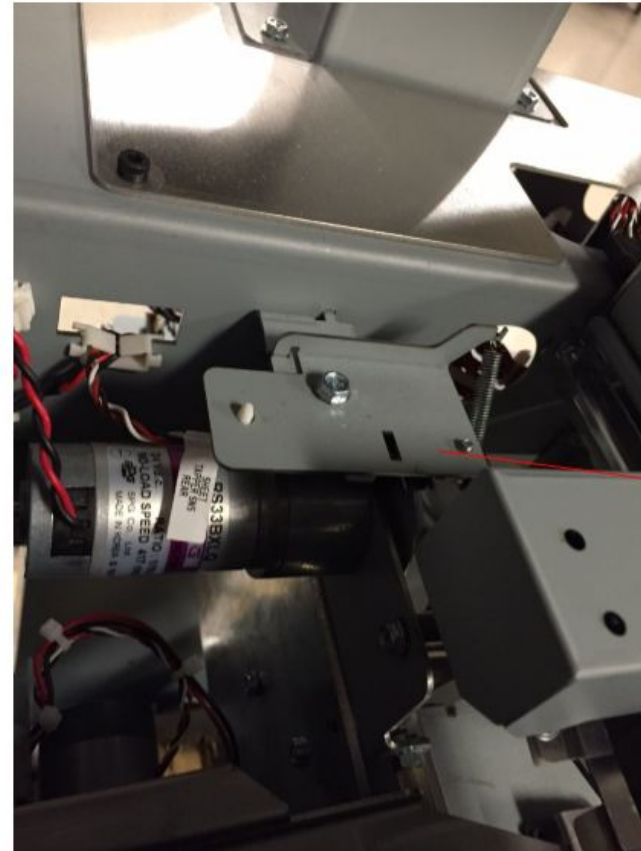

S19

S19 is located in the tapper at the rear of the machine

**Locate Sensor S20:**

- Slide the Element Feeder Drawer all the way out of the machine.
- Remove the Element Spool
- Manually actuate the sensor slack mechanism to block or unblock the sensor. If there is dust or debris located at the bottom of the Element Feeder, vacuum the area around the slack sensor.
- If actuating the Slack Sensor mechanism is inconclusive, follow REP 3.1 to remove the Slack Sensor mechanism and gain direct access to the Sensor.

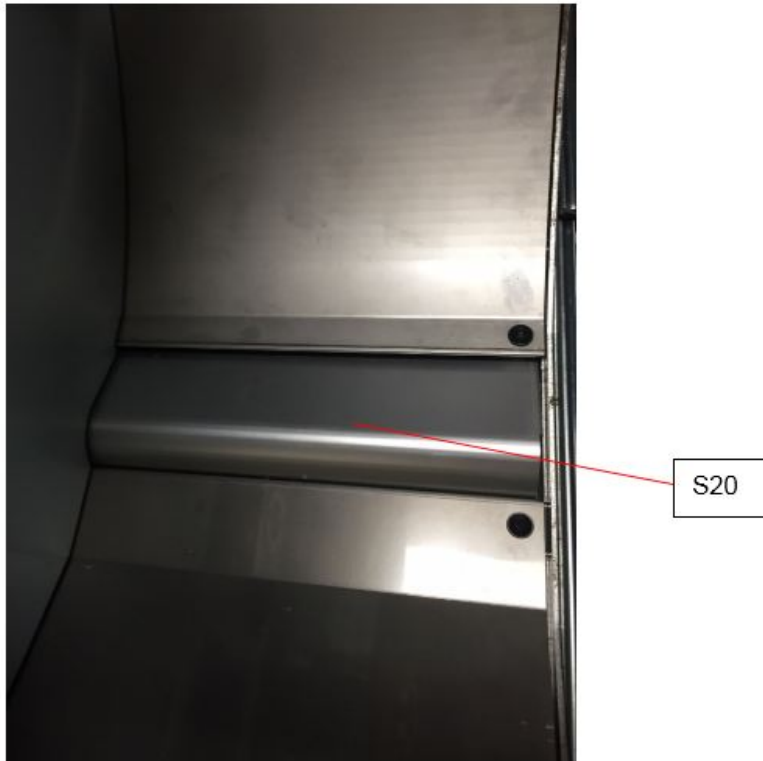

**S20 is located at the bottom of the Element Feeder Assembly. It can be blocked or unblocked by pressing manually on the Slack Detect mechanism.**

**Locate Sensor S24:**

- Slide the Element Feeder Drawer all the way out of the eWire.
- Manually raise and lower the pushover mechanism to block and unblock the sensor.

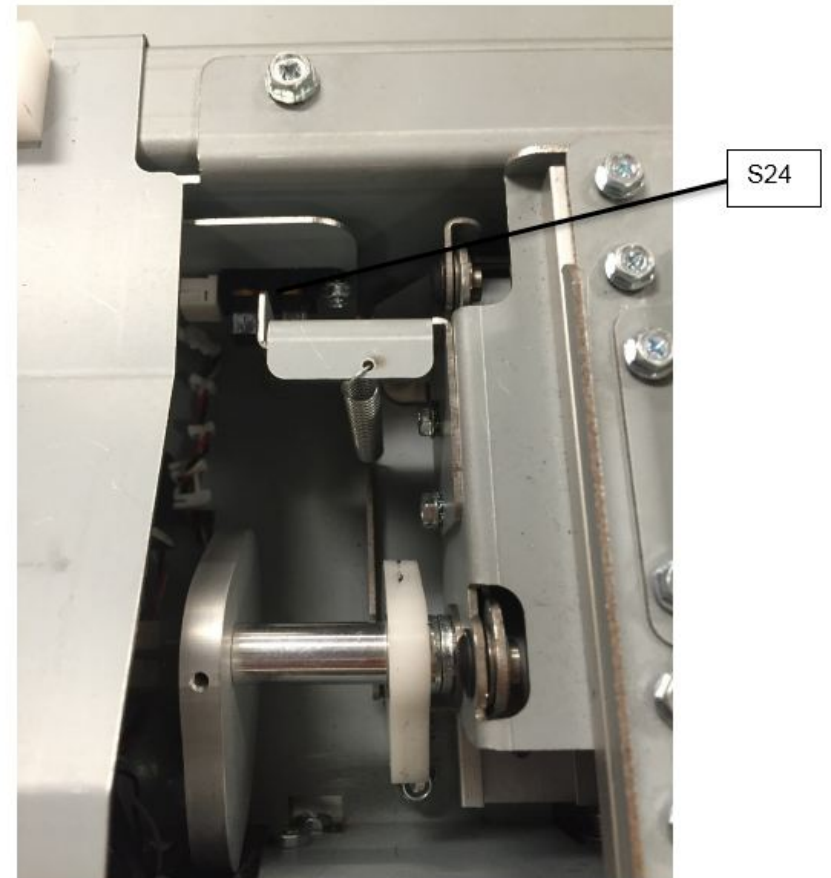

**S24 is located on the Element Transfer Module**

#### Locate Sensor S31:

- Slide the Element Feeder Drawer all the way out of the eWire.
- Locate the Pushover Motor on the rear side of the Element Transfer Module.
- Remove the Sensor Bracket by removing the M3 Screws (3), without disconnecting the Sensor cable.
- The sensor can be blocked and unblocked using a piece of paper or other object.

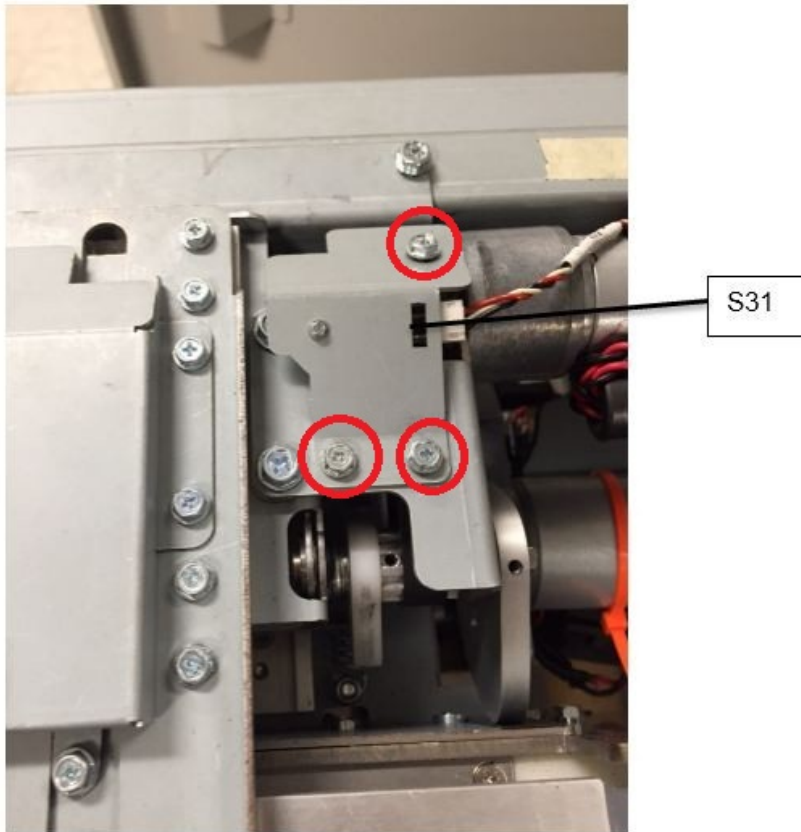

S31 is located on the Element Transfer Module

#### Locate Sensor S32 and S33:

- Slide the Element Feeder Drawer all the way out of the eWire.
- Remove the Element Feeder Cover 7717335 by removing the M3 Screws (4). Refer to REP 3.15.3.
- If necessary, go to GP 6.3.3 and use the Motors Procedure to cycle Motor M13. Remove the Interlock Cheater when the sensor flag is in the desired location. This will allow you to block or unblock each sensor.

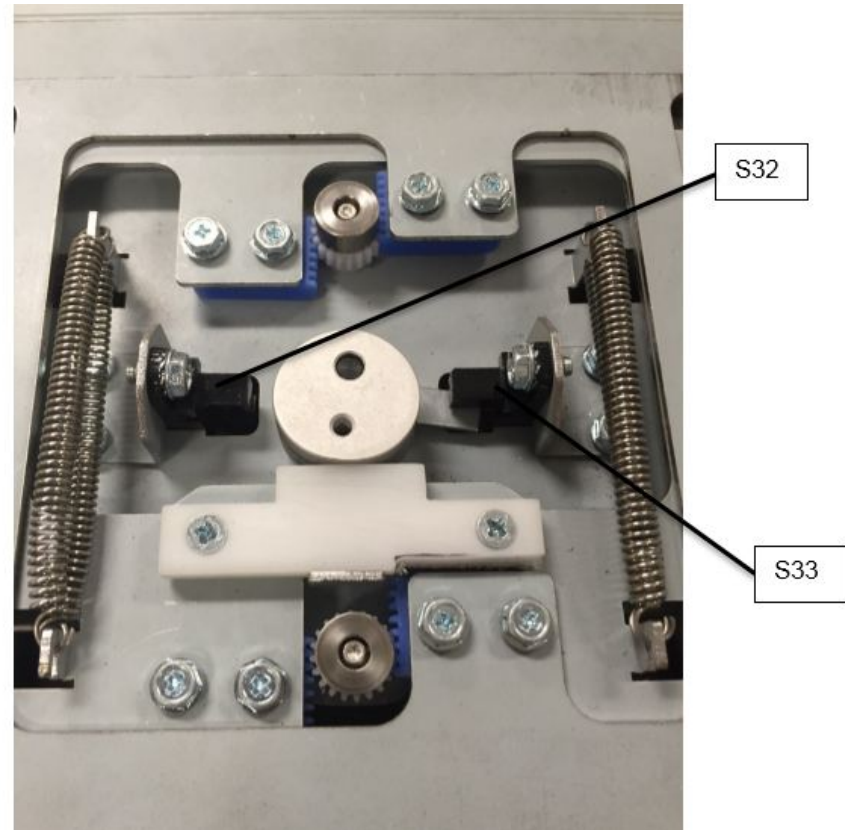

S32 and S33 are located on the Expanding T Module

**Locate Sensor S34 and S35:**

- Raise the Top Cover
- Manually move the closer module forward if needed to view the Holder Rotate linkage
- If the sensor is unblocked, it can be blocked by inserting a piece of paper or other solid object.
- If the sensor is blocked, do REP 8.2 to remove the Holder Rotate Bracket, but do not disconnect the Sensor cables. This will allow you to block or unblock the sensor manually.

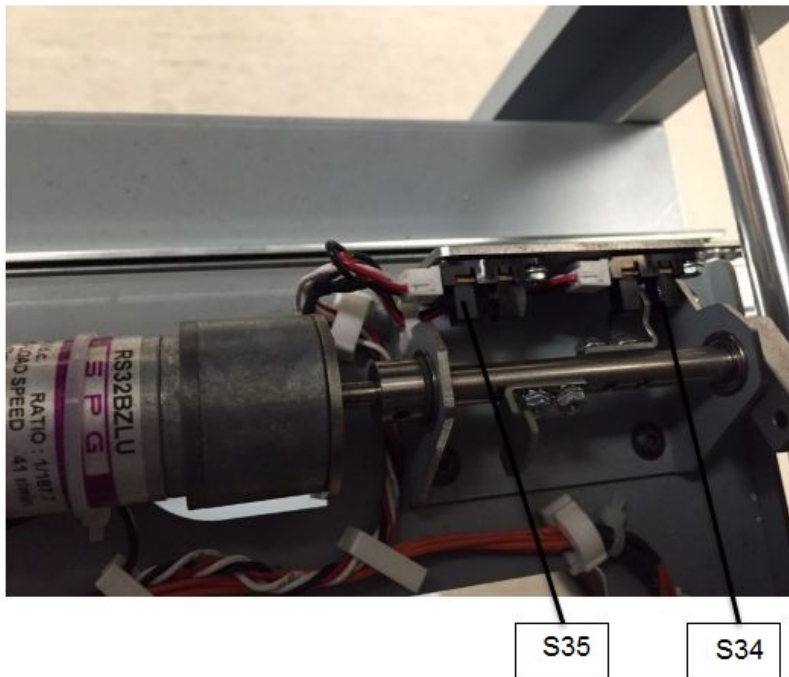

**S34 and S35 are located on the Holder Module Rotate Mechanism**

**Locate Sensor S36, S37, S39:**

- Raise the Top Cover
- Manually move the closer module forward or back to gain access if necessary
- Manually cycle the holder mechanism if necessary

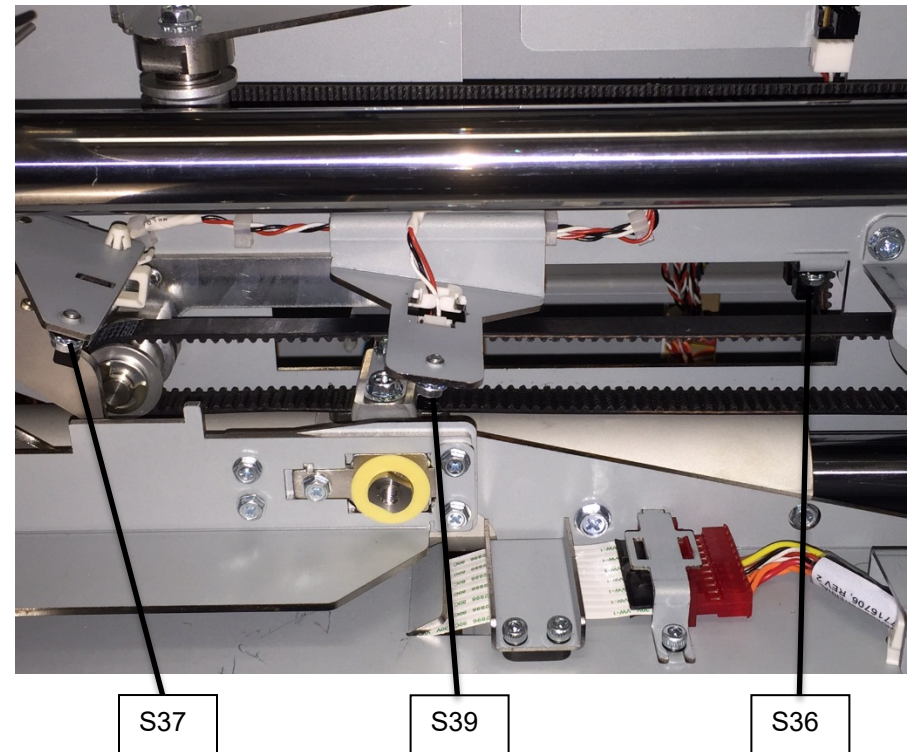

**S36, S37 and S39 are located on the Holder Module**

### Locate Sensor S38 and S40:

- Do REP 1.5 to remove the Back Cover.
- S38 and S40 are most easily viewed from the back.
- If necessary, move the Holder Module manually to unblock the sensor.
- S38 and S40 are located on the Holder Module.

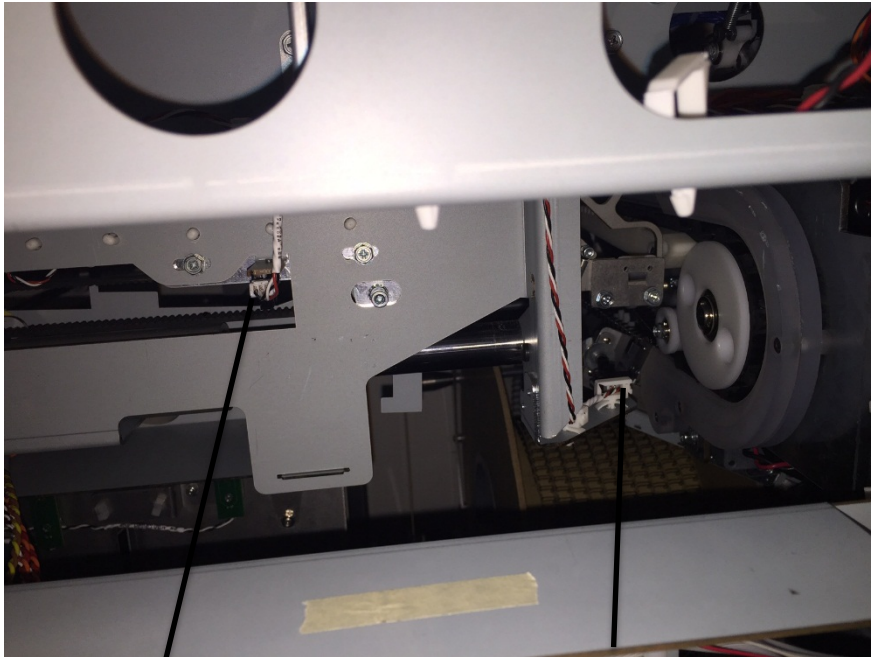

S38

S40

S38 and S40 are located on the Holder Module

### Locate Sensor S41:

- S41 is located on the Alignment Module.
- In order to test S41, do GP 6.3.4 Functional Tests and select "Aligner Test." Remove the Interlock cheater before the Functional Test is complete. Return to Sensor Check mode to confirm the sensor is unblocked. Insert the cheater which will cause the Aligner to home. S41 should then be blocked.

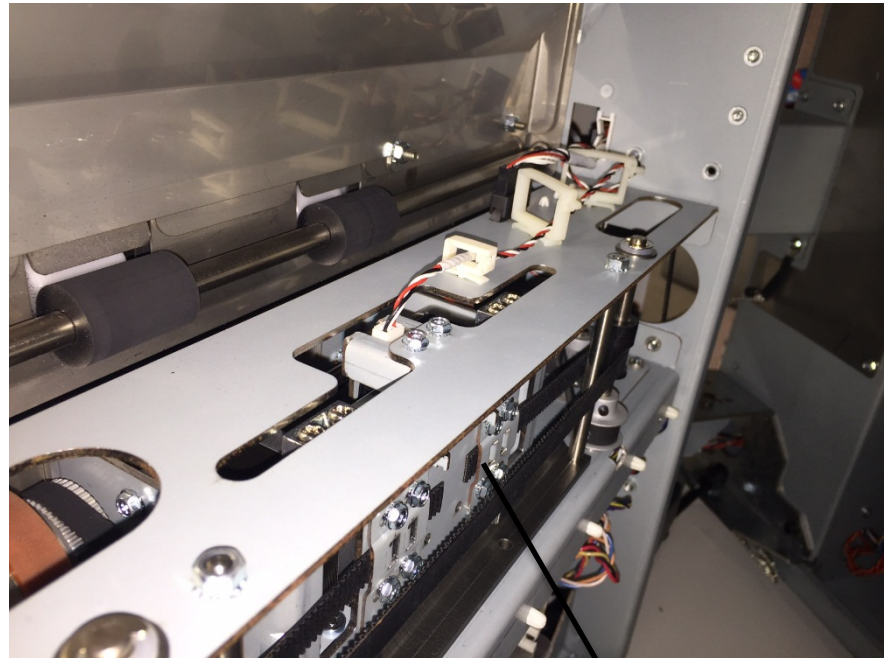

S41

S41 is located on the Alignment Module

### Locate Sensor S46 and S49:

- **Raise the Top Cover and Lower Bypass.**
- **Manually move the closer module forward or back if needed to unblock the Sensor.**
- **The Sensor can be blocked or unblocked by inserting a piece of paper or other solid object.**

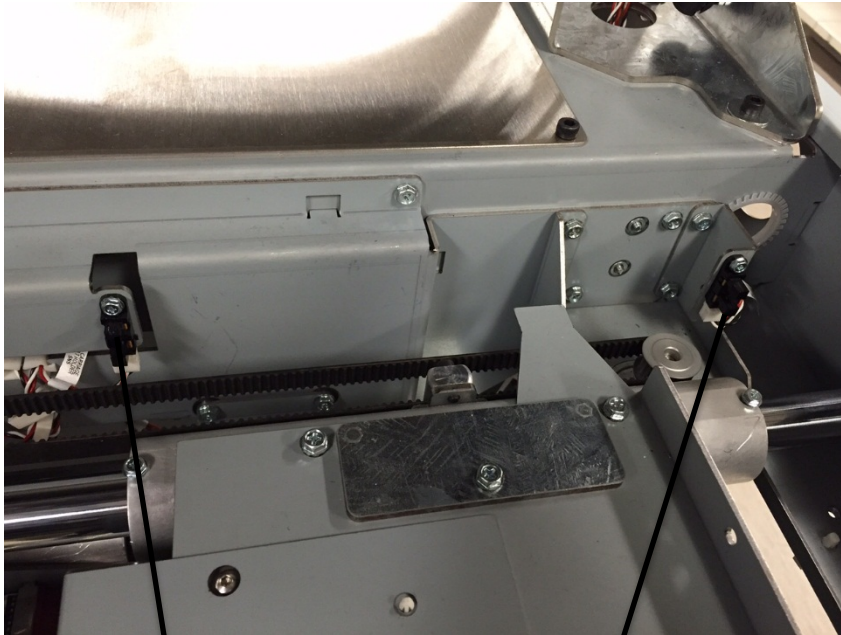

S49

S46

**S46 and S49 are located the back frame behind the closer**

### Check Sensors Procedure (S18-S20, S24, S31-S41, S46-S49)

1. Do [GP 6.3.1 SENSORS Procedure](#). Check to make sure all sensors show “0” on the LCD when unblocked and “1” when blocked.

If any sensor shows “1” when unblocked, clean that sensor. Also check if there is any obstruction in the sensor path.

**All sensors show “0” when uncovered and “1” when covered**

**Yes-** Return to the RTP that directed you here.

**No-**Go to Step 2

2. Make sure the sensor wire is connected securely at the Sensor and at the Main Control Board (PL 5.27). Do REP 1.5 to remove the Rear Cover to gain access to the connector at the Control Board. Refer to Section 7 Wiring and [GP 6.22](#) to find the Cable termination locations.

**All the connections are made securely**

**Yes-** Go to Step 3

**No-** Make the connection and repeat Step 1.

3. Replace the Sensor with a new one (alternatively, swap the sensor in the faulty position with a sensor from a different good position to check if it is a bad sensor).

**Replacing the sensor corrects the issue**

**Yes-**Use the new sensor and return to normal operation

**No-**Go to Step 4

4. Visually inspect the Cable from the sensor all the way to the Control Board (PL 5.27). If the Cable is damaged, replace the Cable. See Section 7 and GP 6.22 for cable part numbers and locations.

**Sensor cable looks okay**

**Yes-**Go to Step 5

**No-**Go to Step 6

5. Do [GP 6.3.5 FIRMWARE UPGRADE Procedure](#) to Re-flash the firmware for the eWire.

**Re-flashing firmware clears the fault**

**Yes-** Resume normal operation

**No-** Go to Step 7

6. Do REP 11.2 to replace the Main Control Board (PL 5.27).

**This clears the fault**

**Yes-** Resume normal operation

**No-** Escalate to second level

#### GP 6.4.4 Check S21, S22, S25, S42

Use the information in this section to locate the appropriate sensor(s) on the eWire. Once you have located the sensor, follow [GP 6.3.1](#) to verify the function of the sensor. If the sensor does not operate as expected, follow the troubleshooting steps located in this section to fix the faulty sensor.

##### Locate Sensor S21:

- Slide the Element Feeder Drawer all the way out of the eWire.

#### WARNING

**Moving Parts, keep hands clear of all moving parts when the Interlock Cheater is inserted. Keep fingers away from the Knife Mechanism when power is on. See Section 0, page vii for other languages.**

- To check S21, feed a piece of wire through the knife area using the manual advance knob.



S21 is located on the Knife Module

##### Locate Sensor S22:

- Slide the Element Feeder tray all the way out of the eWire.
- Clean the dust off of the film covering the sensor (do not remove this film)
- Block the Sensor path by sliding a piece of wire element between the Element Feed Belt and the Expanding T mechanism.
- Do GP Functional Tests→Feed Element. Use the knob to advance the cut wire. Ensure that the S22 sensor changes state when blocked by the sensor.

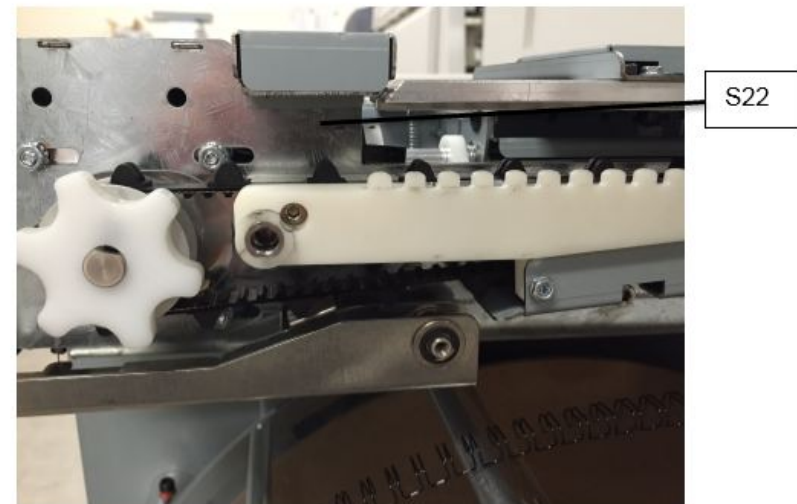

S22 is a beam sensor, it detects presence of an element in the area shown

If S22 is operational but does not show as blocked when wire is present, adjust the sensor alignment until it detects wire every time.

### Locate Sensor S25:

- Slide the Element Feeder tray all the way out of the eWire.
- Remove any remaining Element from the Element Feeder Belt.
- Manually turn the Element Feeder Belt using the Knob. Sensor S25 detects a tooth on the belt, and will cycle on and off when the belt is rotated.

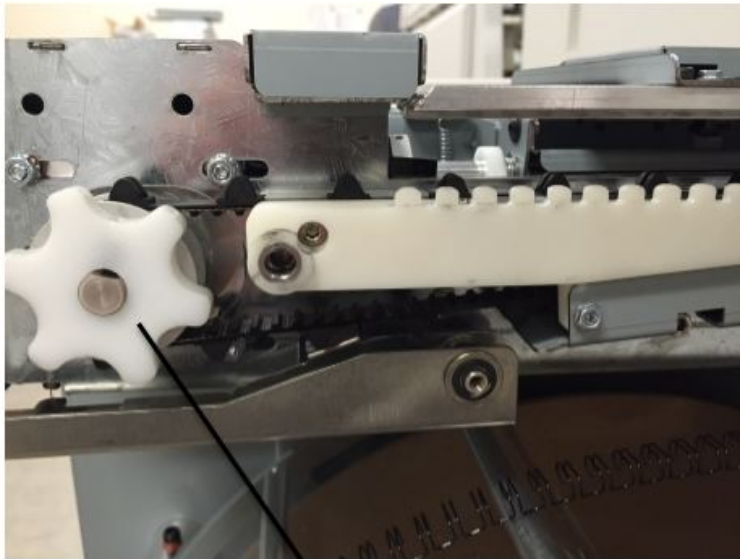

Rotate Knob

S25 detects the belt tooth, block and unblock it by manually advancing the belt

### Locate Sensor S42:

- Slide the book drawer tray all the way out of the eWire.
- Block the sensor path by covering the sensor beam path holes at the upper portion of the book drawer.
- S42 has 2 emitters and 2 receivers, both must be blocked to check the sensor.

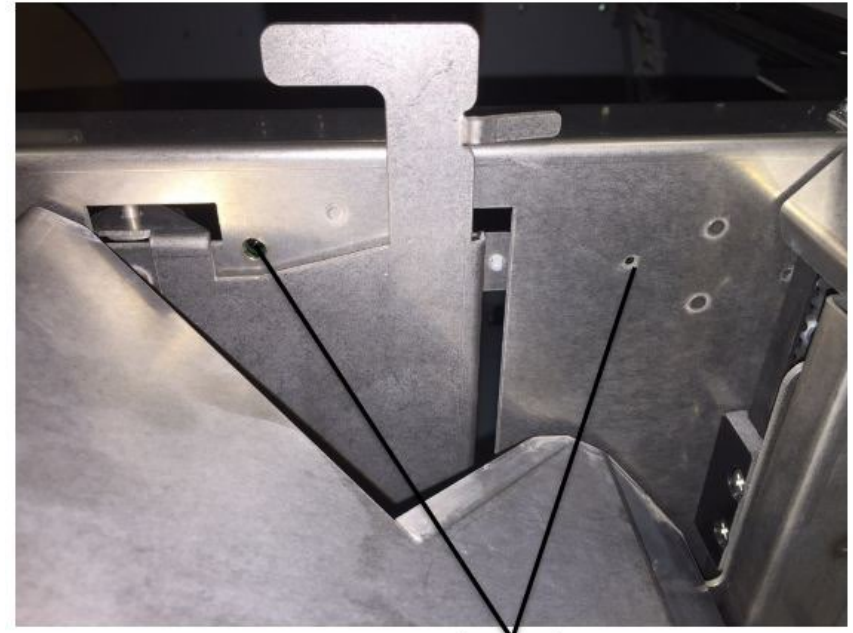

S42

S42 is located in the book drawer



## Check Sensors Procedure (S21, S22, S25, S42)

1. Do [GP 6.3.1 SENSORS Procedure](#). Check to make sure S21, S22, and S25 change state from “1” to “0” when blocked. S42 will change from “0” to “1”

If any sensor shows “0” when uncovered, clean that sensor. Also check if there is any obstruction in the sensor window. Use compressed air to clear dust from sensor area.

### All sensors operate correctly

**Yes-** Go to Step 2

**No-**Go to Step 3

2. Test the open voltage reading of the sensor. To do this, ensure that the path between the sensors is clear, and place one lead of a multi-meter on the test point with the appropriate sensor label on the AC board, and the other lead on the ground test point.

### Voltage reading is less than 0.4V

**Yes-** Go to Step 3

**No-**Go to Step 4

3. Make sure the sensor wire is connected securely at the Sensor and at the Main Control Board (PL 5.27). Do REP 1.5 to remove the Rear Cover to gain access to the connector at the Control Board. Refer to [GP 6.22](#) to locate the termination location for each sensor. For S22 see details at the end of this section.

### All the connections are made securely

**Yes-** Go to Step 4

**No-** Make the connection and return to normal operation.

4. Replace the faulty sensor board.

### This clears the fault

**Yes-** Resume normal operation

**No-** Go to Step 5

5. Visually inspect the Cable from the sensor all the way to the Control Board (PL 5.27). If the Cable is damaged, replace the Cable. See Section 7 and [GP 6.22](#) for cable part numbers and locations.

### Sensor cable looks okay

**Yes-**Go to Step 6

**No-**Go to Step 7

6. Do [GP 6.3.5 FIRMWARE UPGRADE Procedure](#) to Re-flash the firmware for the eWire.

### This clears the fault

**Yes-** Resume normal operation

**No-** Go to Step 7

7. Do REP 11.2 to replace the Main Control Board (PL 5.27).

### This clears the fault

**Yes-**Resume normal operation

**No-**Escalate to second level

## S22 Cable connections

When checking sensor S22, use the pictures below as reference to ensure that all the cable connections are secure.

Do REP 3.15 to remove the Element Feeder Cover

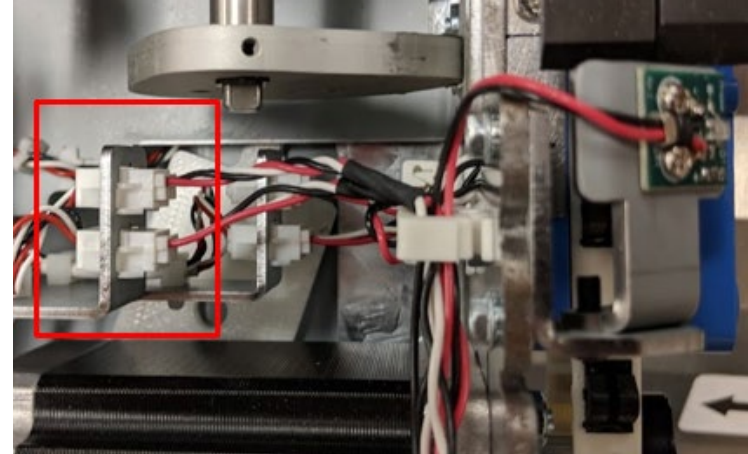

Do REP 3.15 to remove the Upper Element Feeder Rear Panel

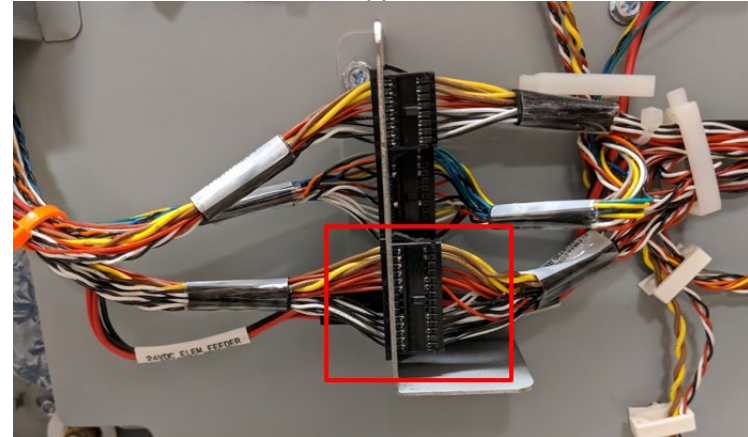

Do REP 1.5 to remove Back Cover

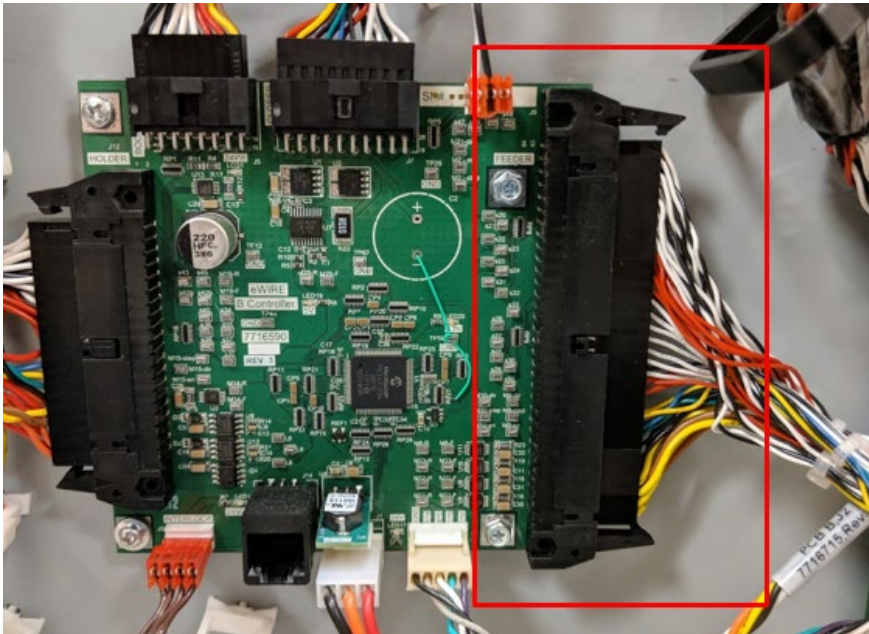
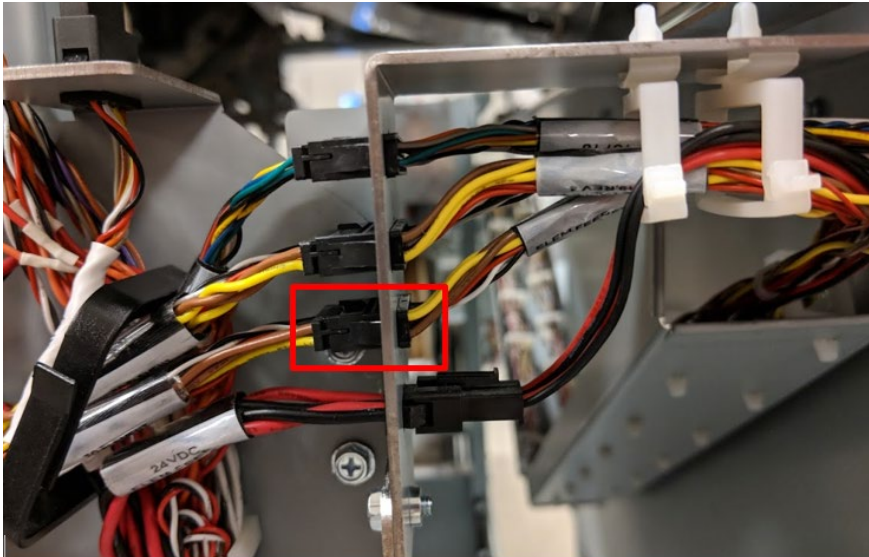

Reinstall all covers.

**GP 6.4.5 Check S26 - S30, S50**

Locate Sensor S26 through S30:

- Slide the Element Feeder tray all the way out of the machine
- [Do GP 6.8](#) to Remove the element spool.
- Sensors can be blocked using a piece of paper.

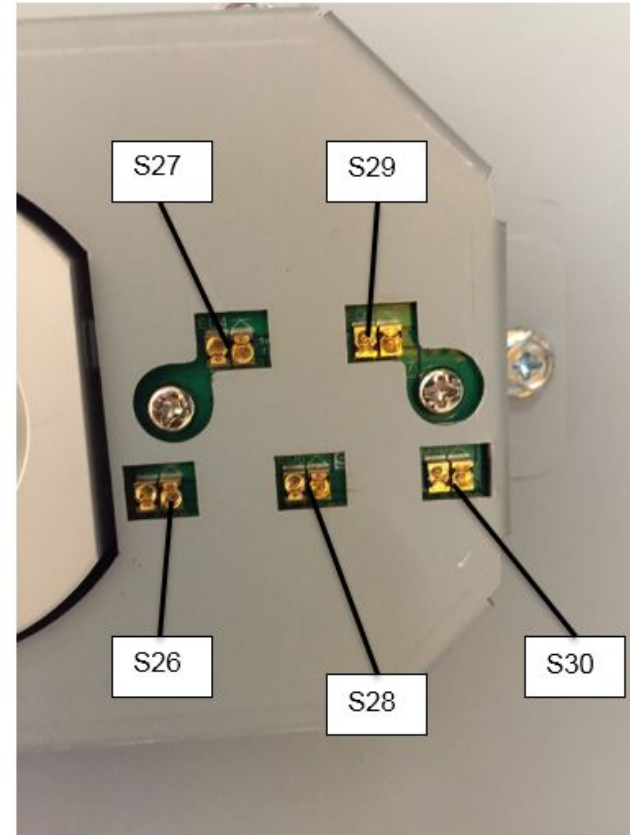

S26 through S30 are located on the front face of the element feeder spindle assembly

## Locate Sensor S50:

- Slide the Element Feeder tray all the way out of the machine
- [Do GP 6.8](#) to Remove the element spool.

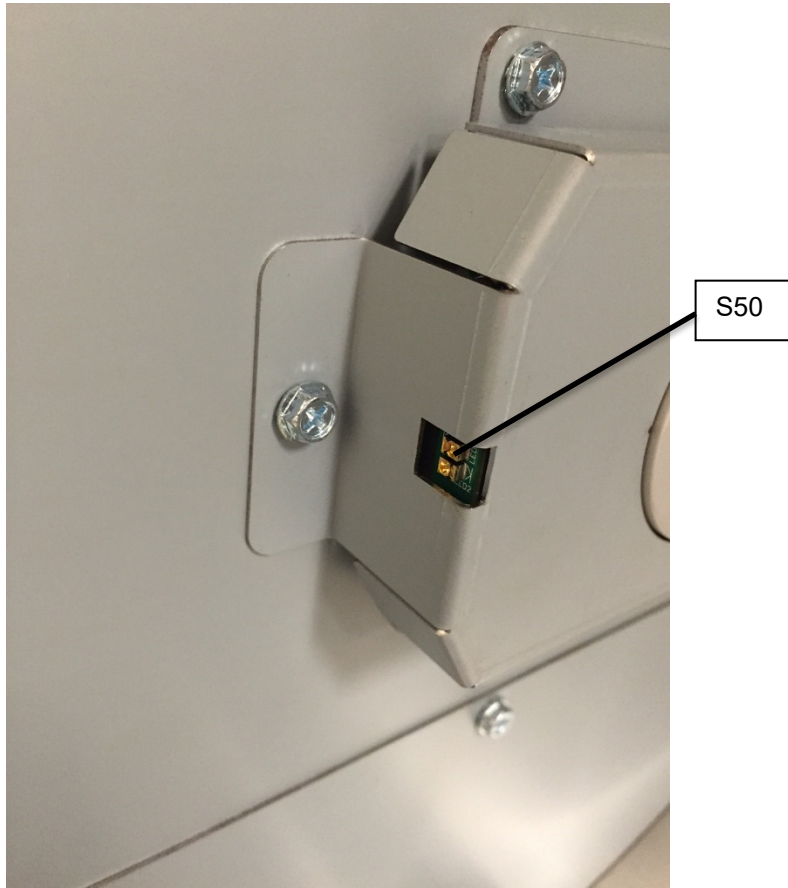

S50 is located on the side face of the element feeder spindle assembly

## Check Sensors Procedure (S26-S30, S50)

1. Do [GP 6.3.1 SENSORS Procedure](#). Check to make sure all sensors show “0” on the LCD when uncovered and “1” when covered.

If any sensor shows “1” when uncovered, clean that sensor. Also check if there is any obstruction in the sensor window.

**All sensors show “0” when uncovered and “1” when covered**

**Yes-** Return to the RTP that directed you here.

**No-**Go to Step 2

2. Make sure the sensor wire is connected securely at the Sensor Board and at the Main Control Board (PL 5.27). Do REP 1.5 to remove the Rear Cover to gain access to the connector at the Control Board. Refer to Section 7 Wiring and [GP 6.22](#) for details on the Sensor Cable and termination location.

**All the connections are made securely**

**Yes-** Go to Step 3

**No-** Make the connection and return to normal operation.

3. Light from sensor components can be viewed with a cell phone camera, if the sensor is working you will be able to see a bright light. Alternately a small mirror can be used. Use this procedure to check that each sensor is emitting a beam of light during operation.

**CAUTION: Sensor emits High Intensity narrow angle Infrared beam (940nm). It is invisible to naked eye, avoid looking directly at the sensor when the machine is powered ON. See Section 0, page ix for other languages.**

**There is no light from any of the sensors on the Sensor Board**

**Yes-** Go to Step 5

**There is no light from one or some of the sensors on the Sensor Board**

**Yes-** Go to Step 4

**There is a bright light from all the sensors**

**Yes-** Go to Step 6

4. Visually inspect the Cable from the sensor board all the way to the Control Board (PL 5.27). If the Cable is damaged, replace the Cable. See Section 7 and [GP 6.22](#) for cable part numbers and locations.

**Sensor cable looks okay**

**Yes-Go to Step 5**

**No-Go to Step 6**

5. Replace the Sensor Board. Refer to REP 3.4 to replace the S26-S30 Sensor Board, and refer to REP 3.5 to replace the S50 Sensor Board.

**This clears the fault**

**Yes-** Resume normal operation

**No-** Go to Step 5

6. Do [GP 6.3.5 FIRMWARE UPGRADE Procedure](#) to Re-flash the firmware for the eWire.

**This clears the fault**

**Yes-** Resume normal operation

**No-** Go to Step 7

7. Do REP 11.1 or 11.2 to replace the Main Control Board (PL 5.27).

**This clears the fault**

**Yes-**Resume normal operation

**No-**Escalate to second level

#### **GP 6.4.6 Check S47, S48**

Use the information in this section to locate the appropriate sensor(s) on the eWire. If the sensor does not operate as expected, follow the troubleshooting steps located in this section to fix the faulty sensor.

**Locate Sensor S47 and S48:**

- S47 and S48 are located inside the Closer Module

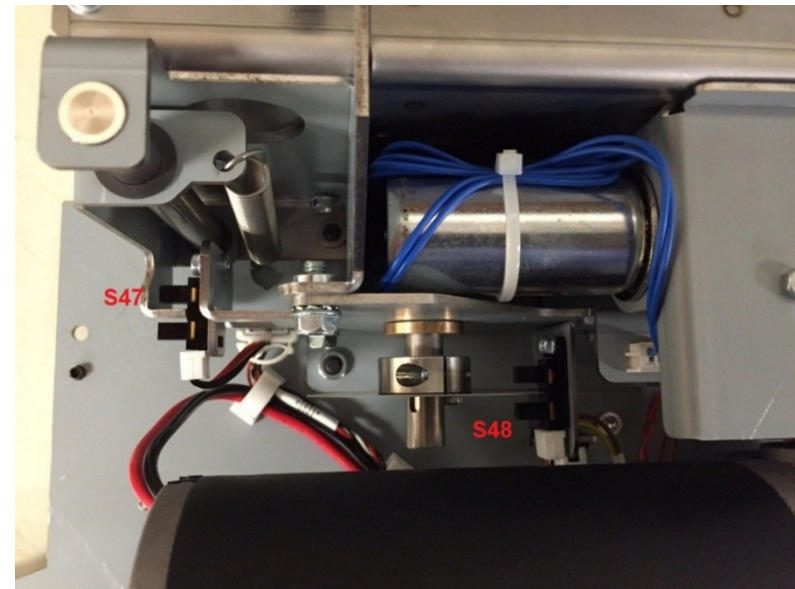

**Check Sensors Procedure (Sensors S47 & S48):**

1. Do REP 6.4 to remove the Closer Motor
2. Do REP 6.1 to install the Closer Module, but leave the Closer Motor detached.
3. Do GP 6.3.1 [SENSOR Check Procedure](#) to view the state of S47 and S48. Rotate the large gear by hand and watch for S47 and S48 to change states. If this is difficult, hold the jaws together with a separate hand while the gear is rotated.

**Both Sensors are working properly**

**Yes-** Do REP 6.4 to reinstall the Closer Motor and return to the procedure that directed you here;

**No-** Go to Step 4

4. Check that the Flat Mylar Closer Cable is plugged in and properly seated in its housing as shown.

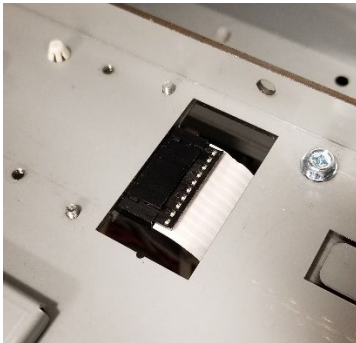

**Both Sensors are working properly**

**Yes-** Do REP 6.4 to reinstall the Closer Motor and return to the procedure that directed you here;

**No-** Go to Step 5

5. Check that the sensor wires are connected securely at the Sensor headers and at the Main Control Board B (PL 5.27). Do REP 1.5 to remove the Rear Cover to gain access to the connector at the Control Board. Refer to Section 7 Wiring and GP 6.22 [Sensor Connections](#) to find the Cable termination locations.

**Both Sensors are working properly**

**Yes-** Do REP 6.4 to reinstall the Closer Motor and return to the procedure that directed you here;

**No-** Go to Step 6

6. Replace the Sensor/s with a known good sensor of the same type (PL 5.19). Refer to [GP 6.4.3](#) to verify the operation of the sensor you are going to use before installing it in the S47 or S48 slot.

**Both Sensors are working properly**

**Yes-** Do REP 6.4 to reinstall the Closer Motor and return to the procedure that directed you here;

**No-** Go to Step 7

7. Inspect the Disk Encoder (PL 5.9). The disk should be positioned in the middle of the S48 sensor. The disk should be flat and should not be loose from the collar. Correct any of these problems and do REP 6.9 Disk Encoder Replacement if needed.

8.

**Yes-** Do REP 6.4 to reinstall the Closer Motor and return to the procedure that directed you here;

**No-** Go to Step 8

9. Verify that the Upper Jaw is moving when the Closer Cams move and is not sticking in any position.

**Upper Jaw moves smoothly with the Closer Cams**

**Yes-** Go to Step 9;

**No-** Inspect the springs on the front and rear of the closer. Do REP 6.6 Closer Spring Replacement if needed.

**Upper Jaw moves smoothly with the Closer Cams**

**Yes-** Go to Step 9;

**No-** Escalate to second level.

10. Visually inspect the Cable from the sensor all the way to the Control Board (PL 5.27). If the Cable is damaged, replace the Cable. See Section 7 and GP 6.22 [Sensor Connections](#) for cable part numbers and locations.

**Sensor cable looks okay**

**Yes-** Go to Step 10;

**No-** Replace the faulty cable/s

**Both Sensors are working properly**

**Yes-** Do REP 6.4 to reinstall the Closer Motor and return to the procedure that directed you here;

**No-** Go to Step 10

11. Do GP 6.3.5 [FIRMWARE UPGRADE Procedure](#) to Re-flash the firmware for the eWire.

**Re-flashing firmware clears the fault**

**Yes-** Resume normal operation

**No-** Go to Step 7

12. Do REP 11.2 to replace the Main Control Board B (PL 5.27).

**This clears the fault**

**Yes-** Resume normal operation

**No-** Escalate to second level

## GP 6.5 MOTOR CHECKS

### GP 6.5.1 Check M1, M2, M4, M16, M17, and M18

#### Locate motors M1, M2, M16, M17, and M18:

- Raise the Lid and insert a cheater into the Interlock.
- Motors M1 and M2 are located on the rear side of the bypass transport assembly (PL 5.3). Motor M1 drives the input side Belt, while Motor M2 drives the output side Belt.
- M16, M17, and M18 are located on the Steering Subassembly (PL 5.3). Motors M16 and M17 drive the front and rear Rollers for skew adjustment. Motor M18 drives the Steering Subassembly for alignment adjustment.
- M4 is located on the baffle of the upper paper transport

#### WARNING

**Moving Parts, keep hands clear of nips and the belts when the Interlock Cheater is inserted. See Section 0, page vii for other languages.**

1. For M1, M2, M4, M16 and M17, do GP 6.3.3 [Motors Procedure](#) to check that the corresponding nip rollers turn when the Motor is activated. Refer to the Jam Areas Diagram to identify the nip roller locations.
2. For Motor 18 only, do GP 6.3.4. [Functional Tests](#) to run the Aligner Test function.

The table below identifies the nip rollers driven by the corresponding motors:

Motor	Nip rollers
M1	N1, N2, N3, N6, N7
M2	N10, N11, N12, N13, N14, N15
M4	N6
M16	N4- Front side steering roller
M17	N5- Rear side steering roller
M18	Alignment Carriage

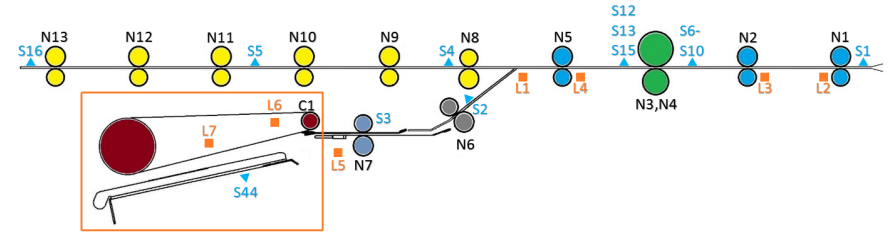

#### The corresponding Nip rollers turn when the Motor is activated

**Yes-** Return to the RTP that directed you here

**No-** Identify the malfunctioning Motor(s) and go to Step 2.

3. Make sure the motor cable is connected securely at the Driver Board and at the Main Control Board (PL 5.27). Do REP 1.5 to remove the Rear Cover to gain access to the connector at the Control Board. Do REP 1.1 to access the M1 and M2 Motor Driver Boards. To access the M16-M18 Driver Boards, raise the Upper and Lower Transport assemblies and remove the Underside cover (refer to REP 2.24).

#### All the connectors are securely connected.

**Yes-** Go to Step 4

**No-** Make the connection and resume operation

4. Inspect the timing belt for the motor. Confirm that the timing belt has appropriate tension and that the belt is not damaged or frayed.

#### Timing belt is okay

**Yes-** Go to Step 5

**No-** Replace the faulty belt and resume operation

5. Check the tightness of the pulley set screw on the stepper motor shaft. Also check the set screws/ coiled spring pins for all the pulleys (PL 5.3) that are driven by the stepper motor in question. Skip this step for M1 and M2, which do not have set screws.

#### All the set screws are secured tightly

**Yes-** Go to Step 6

**No-** Tighten the loose set screw and repeat Step 1

6. Check the DIP switch settings for the Motor. DIP Switches are located on the Driver Board that corresponds with each motor. Refer to the Table below for the correct DIP switch settings for each Motor.

	DIP 1	DIP 2	DIP 3	DIP 4	DIP 5
M1, M2	OFF	ON	OFF	ON	OFF
M4	OFF	ON	OFF	ON	ON
M16	OFF	OFF	ON	ON	ON
M17	OFF	OFF	ON	OFF	ON
M18	OFF	OFF	ON	OFF	OFF

**All the DIP switch setting are correct**

**Yes-** Go to Step 7

**No-** Correct the DIP switch and repeat Step 1

7. Check if there is power to the Driver board. LED 1 on the Driver board should be lit.

If LED 1 is lit, it means there is 24V DC power to the Driver board from the Main Control board.

If LED 2 is lit, it means there is a fault with either the Driver board or the stepper motor.

**LED 1 is not Lit-** Go to Step 8

**LED 1 is Lit-** Go to Step 9

8. Check that the cable(s) connecting the Driver Board 24 VDC signal to the Main Control Board are intact. Refer to the motor cables table to identify the appropriate cable part numbers, [GP 6.24](#).

**The cables look okay**

**Yes-** Go to Step 10

**No-** Replace the faulty cable and repeat Step 1

9. Check that the cable(s) connecting the Driver Board Control signal to the Main Control Board are intact. Refer to the motor cables table to identify the appropriate cable part numbers, [GP 6.24](#).

**The cables look okay**

**Yes-** Go to Step 10

**No-** Replace the faulty cable and repeat Step 1

10. Do GP 6.3.5 [FIRMWARE UPGRADE Procedure](#) to Re-flash the firmware for the eWire

**This clears the fault**

**Yes-** Resume normal operation

**No-** Go to Step 11

11. Replace the driver board for the faulty motor, with DIP switch set correctly for the position you are replacing. Refer to REP 2.17 for Motors M1, M2, and M4. Refer to REP 2.24 for Motors M16, M17, and M18.

**This clears the fault**

**Yes-** Resume normal operation

**No-** Go to Step 12

12. Replace the faulty stepper motor

REP 2.10 for M1 & M2

REP 2.22 for M16 and M17

REP 2.23 for M18

REP 2.28 for M4

**This clears the fault**

**Yes-** Resume normal operation

**No-** Go to Step 13

13. Replace Main Control Board A (REP 11.1)

**This clears the fault**

**Yes-** Resume normal operation

**No-** Escalate to second level

**GP 6.5.2 Check M3 & M5**

**Locate Motors M3 and M5:**

- Raise the top cover and lower bypass
- M3 is located on the deflector module. You should be able to hear the motor run and see the deflector rollers rotate when motor is activated.
- M5 is located on the vacuum stacker module. Refer to PL 5.14. The green belts will turn when M5 is activated.
- Insert a cheater into the upper bypass panel interlock switch

1. Do GP 6.3.3 [Motors Procedure](#) to check that the corresponding motors turn. M3 turns the N8 nip rollers. M5 turns the green belts on the vacuum stacker.

**The corresponding components turn when the Motor is activated**

**Yes-** Return to the RTP that directed you here

**No-** Identify the malfunctioning Motor(s) and go to Step 2.

2. Make sure the motor wire is connected securely at the Driver Board and at the Main Control Board (PL 5.27). Do REP 1.5 to remove the Rear Cover to gain access to the Main Control Board. For Motor M3, the Driver Board is located on the rear of the eWire. For Motor M5, do REP 1.6 to remove the Side Cover. The Motor Driver for M5 is located on the left side of the eWire frame.

**All the connectors are securely connected.**

**Yes-** Go to Step 3

**No-** Make the connection and resume operation

3. Inspect the timing belt for the corresponding motor drive. Ensure that the timing belt is not broken or frayed. Refer to the s below to access the appropriate timing belt.Path Motor Replacement

- M5: Refer to REP 4.9, Stacker Drive Belt Replacement

**Timing Belt Looks OK**

**Yes-** Go to Step 4

**No-** Replace the faulty belt and resume operation

4. Check the tightness of the set screw of pulleys on the stepper motor shaft. Check tightness of the set screws on pulleys driven by the motor timing belt.

**All the set screws are secured tightly**

**Yes-** Go to Step 5

**No-** Tighten the loose set screw and repeat Step 1

5. For the motor in question, check the DIP switch settings for the corresponding Driver Board. Refer to the table below to find the correct DIP Switch settings.

	DIP 1	DIP 2	DIP 3	DIP 4	DIP 5
M3	OFF	ON	OFF	ON	ON
M5	OFF	ON	OFF	ON	OFF

**All the DIP switch setting are correct**

**Yes-** Go to Step 6

**No-** Correct the DIP switch and repeat Step 1

6. Check if there is power to the Driver board. LED 1 on the Driver board should be lit.

If LED 1 is lit, it means there is 24V DC power to the Driver board from the Main Control board.

If LED 2 is lit, it means there is a fault with either the Driver board or the stepper motor.

**LED 1 is not Lit-** Go to Step 7

**LED 1 is Lit-** Go to Step 8

7. Check that the cable(s) connecting the Driver Board 24 VDC signal to the Main Control Board are intact. Refer to the motor cables table to identify the appropriate cable part numbers, refer to [GP 6.24](#)

**The cables look okay**

**Yes-** Go to Step 8

**No-** Replace the faulty cable and repeat Step 1



8. Check that the cable(s) connecting the Driver Board Control signal to the Main Control Board are intact. Refer to the motor cables table to identify the appropriate cable part numbers, [GP 6.24](#)

**The cables look okay**

**Yes-** Go to Step 9

**No-** Replace the faulty cable and repeat Step 1

9. Do GP 6.3.5 [FIRMWARE UPGRADE Procedure](#) to Re-flash the firmware for the eWire

**This clears the fault**

**Yes-** Resume normal operation

**No-** Go to Step 10

10. Replace the driver board for the faulty motor, with DIP switch set correctly for the position you are replacing. Refer to REP 9.6, Stepper Driver Boards Replacement.

**This clears the fault**

**Yes-** Resume normal operation

**No-** Go to Step 11

11. Replace the faulty stepper motor

REP 5.5 for M3

REP 4.5 for M5

**This clears the fault**

**Yes-** Resume normal operation

**No-** Go to Step 12

12. Replace Main Control Board A (REP 11.1)

**This clears the fault**

**Yes-** Resume normal operation

**No-** Escalate to second level

**GP 6.5.3 Check M6 and M7**

**Locate Motors M6 and M7:**

- Raise the top cover and lower bypass
- Insert a cheater into the upper bypass panel interlock switch
- M6 is located on the front tapper assembly. Refer to PL 5.17
- M7 is located on the rear tapper assembly. Refer to PL 5.18
- Alternatively, you can do [GP 6.3.6 Cycle Tappers](#) to cycle both Tappers just once.

1. Do [GP 6.3.3 Motors Procedure](#) to check that the corresponding motors turn when activated.

**The Tapper linkage turns when Motor is activated.**

**Yes-** Return to the RTP that directed you here

**No-** Identify the malfunctioning Motor(s) and go to Step 2.

2. Make sure the motor wire is connected securely at the header and at the Main Control Board (PL 5.27). Do REP 1.5 to remove the Rear Cover to gain access to the connector at the Control Board. Refer to [GP 6.24](#) for termination locations.

**All the connectors are securely connected.**

**Yes-** Go to Step 3

**No-** Make the connection and resume operation

3. Check the tightness of the set screw of the hub on the DC motor shaft.

**Set screw is secured tightly**

**Yes-** Go to Step 4

**No-** Tighten the loose set screw and resume operation

4. Check that the cable(s) connecting the Motor to the Main Control Board are intact. Refer to the motor cables table to identify the appropriate cable part numbers, [GP 6.24](#).

**The cables look okay**

**Yes-** Go to Step 5

**No-** Replace the faulty cable and resume normal operation

5. Do GP 6.3.5 [FIRMWARE UPGRADE Procedure](#) to Re-flash the firmware for the eWire

**This clears the fault**

**Yes-** Resume normal operation

**No-** Go to Step 6

6. Replace the faulty motor. Refer to REP 7.2, Tapper Motor Replacement M6 and M7.

**This clears the fault**

**Yes-** Resume normal operation

**No-** Go to Step 7

7. Replace the cables from the motor to the Main Control Board. Refer to Section 7, Wiring and GP 6.24 to identify the correct cable part numbers.

**This clears the fault**

**Yes-** Resume normal operation

**No-** Go to Step 8

8. Replace Main Control Board A (REP 11.1)

**This clears the fault**

**Yes-** Resume normal operation

**No-** Escalate to second level

**GP 6.5.4 Check M8**

**To access motor M8:**

- Open the door and slide out the Element Feeder.
- Do [GP 6.8](#) to remove the supply spool
- Insert a cheater into the element feeder door interlock switch

1. Do [GP 6.3.3 Motors Procedure](#) to check that the Rewind Spool rotates when Motor M8 is activated.

**The Motor operates as expected**

**Yes-** Return to the RTP that directed you here

**No-** Go to Step 2.

2. Make sure the motor wire is connected securely at the header and at the Main Control Board (PL 5.27). Do REP 1.5 to remove the Rear Cover to gain access to the connector at the Control Board. Refer to REP 3.9 to access the M8 Motor connection.

**All the connectors are securely connected.**

**Yes-** Go to Step 3

**No-** Make the connection and resume operation

3. Inspect the round belt for damage. Remove Element Feeder rear cover to access the belt.

**Belt is okay**

**Yes-** Go to Step 4

**No-** Replace the spindle drive assembly 7718107, Refer to REP 3.9. Repeat Step 1.

4. Check the tightness of the set screw of the pulley on the motor shaft. Check tightness of the set screw on the connected pulley.

**All the set screws are secured tightly**

**Yes-** Go to Step 5

**No-** Tighten the loose set screw and repeat Step 1.

5. Check that the cable(s) connecting the Motor to the Main Control Board are intact. Refer to the motor cables table to identify the appropriate cable part numbers, [GP 6.24](#)

**The cables look okay**

**Yes-** Go to Step 6

**No-** Replace the faulty cable and resume normal operation

6. Do GP 6.3.5 [FIRMWARE UPGRADE Procedure](#) to Re-flash the firmware for the eWire

**This clears the fault**

**Yes-** Resume normal operation

**No-** Go to Step 7

7. Replace the faulty motor. Refer to REP 3.9, Spool Rewind Motor Replacement.

**This clears the fault**

**Yes-** Resume normal operation

**No-** Go to Step 8

8. Replace the cables from the motor to the Main Control Board. Refer to GP 6.24 for cable part numbers.

**This clears the fault**

**Yes-** Resume normal operation

**No-** Go to Step 9

9. Replace Main Control Board, B (REP 11.2)

**This clears the fault**

**Yes-** Resume normal operation

**No-** Escalate to second level

**GP 6.5.5 Check M9 and M10**

**Identify Motor M9 and M10:**

- Slide the element feeder drawer all the way out of the machine
- M9 is located on the Element Feed Sprocket. M10 is located on the Element Feed Belt drive, near the front of the drawer.
- Insert a cheater into the element feeder door interlock switch



1. Do GP 6.3.3 [Motors Procedure](#) to check the motors activate as expected. M9 will rotate the Element Feed Sprocket. M10 will rotate the Element Feeder Belt.

**Motors turn as expected**

**Yes-** Return to the RTP that directed you here

**No-** Go to Step 2.

2. Make sure the motor wire is connected securely at the Driver Board and at the Main Control Board (PL 5.27). Do REP 1.5 to remove the Rear Cover to gain access to the connector at the Control Board. Refer to REP 3.8 to locate the M9 motor cable connections.

**All the connectors are securely connected.**

**Yes-** Go to Step 3

**No-** Make the connection and resume operation

3. Inspect the element feed belt. Manually advance the belt using the attached knob to confirm that the belt is intact, and that nothing is hindering the smooth advance of the belt.

**Belt looks OK**

**Yes-** Go to Step 4

**No-** Follow REP 3.6 to replace 7716993, Element Feeder Belt.

4. Check the tightness of the set screw of the pulley on the stepper motor shaft.

**All the set screws are secured tightly**

**Yes-** Go to Step 5

**No-** Tighten the loose set screw and repeat Step 1

5. Check the DIP switch settings for the Driver Board. Refer to the table below.

	DIP 1	DIP 2	DIP 3	DIP 4	DIP 5
M9	ON	OFF	ON	OFF	ON
M10	ON	OFF	ON	OFF	OFF

**DIP switch setting are correct**

**Yes-** Go to Step 6

**No-** Correct the DIP switch and repeat Step 1

6. Check if there is power to the Driver board. LED 1 on the Driver board should be lit.

If LED 1 is lit, it means there is 24V DC power to the Driver board from the Main Control board.

If LED 2 is lit, it means there is a fault with either the Driver board or the stepper motor.

**Continue to Step 7**

7. Check that the cable(s) connecting the Driver Board to the Main Control Board are intact. Refer to the motor cables table to identify the appropriate cable part numbers, [GP 6.24](#)

**The cables look okay**

**Yes-** Go to Step 8

**No-** Replace the faulty cable and resume normal operation

8. Do GP 6.3.5 [FIRMWARE UPGRADE Procedure](#) to Re-flash the firmware for the eWire

**This clears the fault**

**Yes-** Resume normal operation

**No-** Go to Step 9

9. Replace the driver board for the faulty motor, with DIP switch set correctly for the position you are replacing.

**This clears the fault**

**Yes-** Resume normal operation

**No-** Go to Step 10

10. Replace the faulty stepper motor. Refer to REP 3.8 for motor M9 and REP 3.7 for motor M10.

**This clears the fault**

**Yes-** Resume normal operation

**No-** Go to Step 11

11. Replace the cables from control board to driver board. Refer to GP 6.24 for cable identification.

**This clears the fault**

**Yes-** Resume normal operation

**No-** Go to Step 12

12. Replace Main Control Board B (REP 11.2)

**This clears the fault**

**Yes-** Resume normal operation;

**No-** Go to Step 13.

13. Replace Main Control Board A (REP 11.1)

**This clears the fault**

**Yes-** Resume normal operation;

**No-** Escalate to second level

**GP 6.5.6 Check M11**

**WARNING**

**Moving Parts, keep hands clear of the knife when performing motor checks. Make sure that power is disconnected from the machine before touching any components attached to the knife.**

**Locate motor M11:**

- Slide the element feeder drawer all the way out of the machine.
  - The knife module is located near the element feed sprocket knob, refer to PL 5.11
  - Insert a cheater into the element feeder door interlock switch
1. Do GP 6.3.4 [Functional Test](#) “Knife Cycle” to check the function of the Knife Motor. Knife blade should cycle forward and back when the functional test is operated.

**Knife motor operates as expected**

**Yes-** Return to the RTP that directed you here

**No-** Go to Step 2.

2. Make sure the motor wire is connected securely at the header and at the Main Control Board (PL 5.27). Do REP 1.5 to remove the Rear Cover to gain access to the connector at the Control Board. Refer to [GP 6.24](#) to identify termination location.

**All the connectors are securely connected.**

**Yes-** Go to Step 3

**No-** Make the connection and resume operation

3. Do GP 6.3.5 [FIRMWARE UPGRADE](#) to Re-flash the firmware for the eWire

**This clears the fault**

**Yes-** Resume normal operation;

**No-** Go to Step 4

4. Do REP 3.15 to replace the Knife Module 7716862

**This clears the fault**

**Yes-** Resume normal operation

**No-** Go to Step 5

5. Replace the cables from the motor to the Main Control Board. Refer to [GP 6.24](#) for cable identification.

**This clears the fault**

**Yes-** Resume normal operation

**No-** Go to Step 6

6. Replace Main Control Board B (REP 11.2)

**This clears the fault**

**Yes-** Resume normal operation

**No-** Escalate to second level

**GP 6.5.7 Check M12 and M13**

**WARNING**

**Moving Parts, keep hands clear of the knife when performing motor checks. Make sure that power is disconnected from the machine before touching any components attached to the knife.**

**Locate motor M12 and M13:**

- Slide the element feeder drawer all the way out of the machine.
- M12 Pushover Motor moves the expanding T mechanism forward and back. M13 Expanding T motor expands the Expanding T rails.
- Insert a cheater into the element feeder door interlock switch

1. Do GP 6.3.4 [Functional Test](#) "Pushover" to check the function of the Pushover Motor. OUT will move the pushover mechanism forward, HOME will move the pushover mechanism back.

Do GP 6.3.3. [Motors Procedure](#) to check the function of the Expanding T motor. The expanding T rails should open and close when M13 is activated.

**Motor operates as expected**

**Yes-** Return to the RTP that directed you here

**No-** Go to Step 2.

2. Make sure the motor wire is connected securely at the header and at the Main Control Board (PL 5.27). Do REP 1.5 to remove the Rear Cover to gain access to the connector at the Control Board. Refer to [GP 6.24](#) to identify termination location.

**All the connectors are securely connected.**

**Yes-** Go to Step 3

**No-** Make the connection and resume operation

3. Do GP 6.3.5 [FIRMWARE UPGRADE](#) to Re-flash the firmware for the eWire

**This clears the fault**

**Yes-** Resume normal operation;

**No-** Go to Step 4

4. Do REP 3.15.8 to replace motor M13 or REP 3.15.7 to replace motor M12.

**This clears the fault**

**Yes-** Resume normal operation

**No-** Go to Step 5

5. Replace the cables from the motor to the Main Control Board. Refer to [GP 6.24](#) for cable identification.

**This clears the fault**

**Yes-** Resume normal operation

**No-** Go to Step 6

6. Replace Main Control Board B (REP 11.2)

**This clears the fault**

**Yes-** Resume normal operation

**No-** Escalate to second level

**GP 6.5.8 Check M15 and M21**

**WARNING**

**Moving Parts, keep hands clear of the eWire when performing motor checks. Make sure that power is disconnected from the machine before touching any moving parts.**

**Locate Motor M15 and M21:**

- Open the lid and raise the lower bypass panel.
- M15 drives the linear travel belt for the Holder Module. M21 drives the linear travel belt for the Closer Module.

1. To check the motor function, manually move the Closer Module and Holder Module forward. When an interlock cheater is inserted, the Closer and Holder will return to their home positions (at the far right of the eWire).

**Motors return to home position as expected**

**Yes-** Return to the RTP that directed you here

**No-** Go to Step 2.

2. Make sure the motor wire is connected securely at the Driver Board and at the Main Control Board (PL 5.27). Do REP 1.5 to remove the Rear Cover to gain access to the connector at the Control Board. The motor Driver boards are located on the rear of the eWire Frame.

**All the connectors are securely connected.**

**Yes-** Go to Step 3

**No-** Make the connection and resume operation

3. Inspect the timing belt. Confirm that the belt is not frayed or worn and that no teeth are missing.

**Belt looks OK**

**Yes-** Go to Step 4

**No-** Follow REP 8.10 to replace Closer Linear Belt or 8.11 and 8.12 to replace Holder Linear Belt.

4. Check the tightness of the set screw of the pulley on the stepper motor shaft.

**All the set screws are secured tightly**

**Yes-** Go to Step 5

**No-** Tighten the loose set screw and repeat Step 1

5. Check the DIP switch settings for the Driver Board. Refer to the table below.

	DIP 1	DIP 2	DIP 3	DIP 4	DIP 5
M15	OFF	OFF	ON	OFF	OFF
M21	OFF	OFF	ON	OFF	OFF

**DIP switch setting are correct**

**Yes-** Go to Step 6

**No-** Correct the DIP switch and repeat Step 1

6. Check if there is power to the Driver board. LED 1 on the Driver board should be lit.

If LED 1 is lit, it means there is 24V DC power to the Driver board from the Main Control board.

If LED 2 is lit, it means there is a fault with either the Driver board or the stepper motor.

**Continue to Step 7**

7. Check that the cable(s) connecting the Driver Board to the Main Control Board are intact. Refer to the motor cables table to identify the appropriate cable part numbers, [GP 6.24](#)

**The cables look okay**

**Yes-** Go to Step 8

**No-** Replace the faulty cable and resume normal operation

8. Do GP 6.3.5 [FIRMWARE UPGRADE Procedure](#) to Re-flash the firmware for the eWire

**This clears the fault**

**Yes-** Resume normal operation

**No-** Go to Step 9



9. Replace the driver board for the faulty motor, with DIP switch set correctly for the position you are replacing.

**This clears the fault**

**Yes-** Resume normal operation

**No-** Go to Step 10

10. Replace the faulty stepper motor. Refer to REP 8.7 for motor M15 and REP 8.8 for motor M21.

**This clears the fault**

**Yes-** Resume normal operation

**No-** Go to Step 11

11. Replace the cables from control board to driver board. Refer to [GP 6.24](#) for cable identification.

**This clears the fault**

**Yes-** Resume normal operation

**No-** Go to Step 12

12. Replace Main Control Board B (REP 11.2)

**This clears the fault**

**Yes-** Resume normal operation;

**No-** Go to Step 13.

13. Replace Main Control Board A (REP 11.1)

**This clears the fault**

**Yes-** Resume normal operation;

**No-** Escalate to second level

**GP 6.5.9      Check M14**

**WARNING**

**Moving Parts, keep hands clear of the eWire when performing motor checks. Make sure that power is disconnected from the machine before touching any moving parts.**

**Locate motor M14:**

- Open the lid and raise the lower bypass.
  - The Holder Rotate motor is located on the back of the Holder, at the far right of the eWire.
  - Insert a cheater into the top cover Interlock switch.
1. Do GP 6.3.4 [Functional Test](#) “Holder Rotate” to check the function of the Holder Rotate Motor.

**Knife motor operates as expected**

**Yes-** Return to the RTP that directed you here

**No-** Go to Step 2.

2. Make sure the motor wire is connected securely at the header and at the Main Control Board (PL 5.27). Do REP 1.5 to remove the Rear Cover to gain access to the connector at the Control Board. Refer to [GP 6.24](#) to identify termination location.

**All the connectors are securely connected.**

**Yes-** Go to Step 3

**No-** Make the connection and resume operation

3. Do GP 6.3.5 [FIRMWARE UPGRADE](#) to Re-flash the firmware for the eWire

**This clears the fault**

**Yes-** Resume normal operation;

**No-** Go to Step 4

4. Check the tightness of the setscrew on the M14 motor shaft. Check the tightness of all screws in the Holder Rotate Linkage.

**All components are securely tightened**

**Yes-** Go to Step 5

**No-** Tighten up the screws and repeat Step 1.

5. Replace the cables from the motor to the Main Control Board. Refer to [GP 6.24](#) for cable identification.

**This clears the fault**

**Yes-** Resume normal operation

**No-** Go to Step 6

6. Replace Main Control Board B (REP 11.2)

**This clears the fault**

**Yes-** Resume normal operation

**No-** Escalate to second level

**WARNING**

**Moving Parts, keep hands clear of the eWire when performing motor checks. Make sure that power is disconnected from the machine before touching any moving parts.**

**Locate motor M19:**

- Motor M19 is located on the Book Drawer.
- Open the book drawer door all the way
- Insert a cheater into the Book Tray Interlock

1. Do GP 6.3.4 [Functional Test](#) “Tray Home” to check the function of the Book Drawer Motor. The book drawer should rise all the way to its up position. If it is already up, it will move down slightly and return home.

**Motor operates as expected**

**Yes-** Return to the RTP that directed you here

**No-** Go to Step 2.

2. Make sure the motor wire is connected securely at the header and at the Main Control Board (PL 5.27). Do REP 1.5 to remove the Rear Cover to gain access to the connector at the Control Board. Refer to [GP 6.24](#) to identify termination location.

**All the connectors are securely connected.**

**Yes-** Go to Step 3

**No-** Make the connection and resume operation

3. Do GP 6.3.5 [FIRMWARE UPGRADE](#) to Re-flash the firmware for the eWire

**This clears the fault**

**Yes-** Resume normal operation;

**No-** Go to Step 4

4. Check the tightness of the set screws on the Pulley attached to the motor shaft and the pulley attached to the Book Drawer shaft.

**This clears the fault**

**Yes-** Resume normal operation

**No-** Go to Step 5

5. Inspect the Timing Belt for damage. Make sure that the belt is not frayed or damaged.

**Belt Looks OK**

**Yes-** Go to Step 6

**No-** Replace the Timing Belt.

6. Inspect the Book Drawer for damage or obstructions. Replace any parts that look damaged or worn.

**Book Drawer Mechanism looks OK**

**Yes-** Go to Step 7

**No-** Replace the damaged components.

7. Replace the cables from the motor to the Main Control Board. Refer to [GP 6.24](#) for cable identification.

**This clears the fault**

**Yes-** Resume normal operation

**No-** Go to Step 8

8. Replace Main Control Board B (REP 11.2)

**This clears the fault**

**Yes-** Resume normal operation

**No-** Escalate to second level

**WARNING**

**Moving Parts, keep hands clear of the eWire when performing motor checks. Make sure that power is disconnected from the machine before touching any moving parts.**

**Locate motor M20:**

- Motor M20 is located on the Closer Module.
- Raise the lid and raise the lower bypass panel.
- Insert a cheater into the Top Cover Interlock

1. Follow ADJ 1.11 to remove the Top Closer Cover then do GP 6.3.3 [Motors Procedure](#) to check that the large gear rotates when Motor M20 is activated. The large gear can be seen next to the triangular warning label.

**The Motor operates as expected**

**Yes-** Return to the RTP that directed you here;

**No-** Go to Step 2

2. Make sure the motor wire is connected securely at the header inside the Closer Module. Make sure that the Flat Mylar Closer Cable is connected securely to the Closer Module Internal Wire Harness. Make sure that the closer header is connected securely to the Main Control Board B (PL 5.27). Do REP 1.5 to remove the Rear Cover to gain access to the connector at the Control Board. Refer to GP 6.24 [Motor Connections](#) to identify termination location.

**All the connectors are connected securely and the motor still fails to operate.**

**Yes-** Go to Step 3;

**No-** Return to the RTP that directed you here

3. Do GP 6.3.5 [FIRMWARE UPGRADE](#) to Re-flash the firmware for the eWire

**The Motor operates as expected**

**Yes-** Return to the RTP that directed you here;

**No-** Go to Step 4

4. Do REP 6.4 to remove the M20 Closer Motor. Push and pull on the small and large gear. If there is any motion along their shafts, check that the M4 set screw in each gear is tightened against its respective key. The face of the large gear should be flush with the end of the shaft. The face of the small gear should be coplanar with the large gear when the motor is reinstalled. If this is not the case, loosen the M4 set screw in the small gear and use a flat head screwdriver to push the gear into its proper position before retightening the set screw. Reinstall the Closer Module.

**The Motor operates as expected**

**Yes-** Return to the RTP that directed you here;

**No-** Go to Step 5

5. Replace the M20 Closer Motor (PL 5.19). Note the position of the small gear as outlined in the previous step.

**The Motor operates as expected**

**Yes-** Return to the RTP that directed you here;

**No-** Go to Step 6

6. Replace the 7716702 and 7717348 cables. Refer to [GP 6.24](#) for cable identification.

**The Motor operates as expected**

**Yes-** Return to the RTP that directed you here;

**No-** Go to Step 6

7. Replace Main Control Board B (REP 11.2)

**The Motor operates as expected**

**Yes-** Return to the RTP that directed you here;

**No-** Escalate to second level

## GP 6.6 SOLENOID CHECKS

### GP 6.6.1 Check Solenoids L1, L2, L3, and L4

#### Locate Solenoids L1, L2, L3, and L4:

- Raise the lid by lifting the release handle
- Insert a cheater into the Lid Interlock.
- Solenoid L1, diverter solenoid, is located on the rear of the Lower Transport Assembly. Refer to PL 5.3.
- Solenoids L2, L3, and L4 are located on the top of the Upper Transport Assembly. Refer to PL 5.3.

#### **WARNING**

**Moving Parts, keep hands clear of moving parts when the Interlock Cheater is inserted. See Section 0, page vii for other languages.**

1. Do GP 6.3.2 [SOLENOIDS Procedure](#) to activate and deactivate Solenoid L1, L2, L3, and/or L4
  - The diverter gate should rise and fall when L1 is cycled.

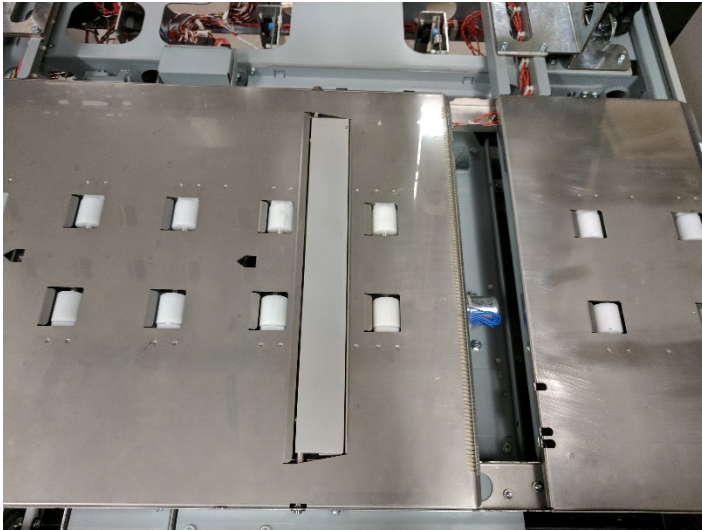

- The corresponding rollers should rise and fall when L2, L3, and L4 are cycled.
  - L2: Nip Rollers N1
  - L3: Nip Rollers N2
  - L4: Nip Rollers N5

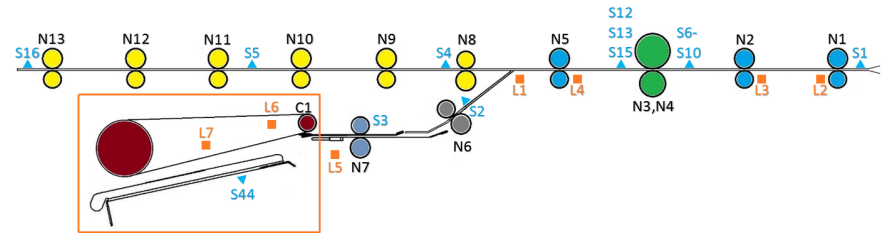

#### **Gates or Rollers rise and fall when solenoids are cycled**

**Yes-** Return to the RTP that directed you here

**No-** Go to Step 2

2. Make sure the solenoid wire is connected securely at the header and at the Main Control Board (PL 5.27). Do REP 1.5 to remove the Rear Cover to gain access to the connector at the Control Board. Refer to [GP 6.26](#) for termination locations.

**All the connectors are securely connected.**

**Yes-** Go to Step 3

**No-** Make the connection and resume operation

3. Check that the cable(s) connecting the Solenoid to the Main Control Board are intact. Refer to the solenoid cables table [GP 6.26](#) to identify the appropriate cable part numbers.

**The cables look okay**

**Yes-** Go to Step 4

**No-** Identify and replace the faulty cable

4. Do GP 6.3.5 [FIRMWARE UPGRADE Procedure](#) to Re-flash the firmware for the eWire

**This clears the fault**

**Yes-** Return to normal operation

**No-** Go to Step 5

5. Replace the solenoid assembly as indicated below

L1: Replace 7718102 diverter solenoid linkage assembly (refer to REP 2.18)

L2 or L3: Replace 7717125 disengaging roller sub-assembly (refer to REP 2.19)

L4: Replace 7717128 disengaging roller sub-assembly (refer to REP 2.20)

**This clears the fault**

**Yes-** Return to normal operation

**No-** Go to Step 6

6. Do REP 11.1 Main Control Board A Replacement.

**This clears the fault**

**Yes-** Return to normal operation

**No-** Escalate to second level

### GP 6.6.2 Check L5 Deflector Solenoids

#### Locate Solenoid L5:

- Raise the top cover by releasing the latch and raise the Lower Bypass Assembly by lifting the handle.
- Raise the Vacuum Module to access the Deflector
- Insert a cheater into the Lid Interlock
- There are two L5 solenoids located on the deflector module, refer to PL 5.16. The Deflector will raise and lower when L5 is activated.



#### **WARNING**

**Moving Parts, keep hands clear of moving parts when the Interlock Cheater is inserted. See Section 0, page vii for other languages.**

1. Do GP 6.3.2 [SOLENOIDS Procedure](#) to activate and deactivate Solenoid L5
  - The deflector mechanism should pivot when solenoid L5 is activated.
  - Look carefully to confirm that the front and rear Deflector Solenoids are both firing simultaneously.

#### Deflector mechanism pivots when L5 is activated

**Yes-** Return to the RTP that directed you here

**No-** Go to Step 2

2. Make sure the solenoid wire is connected securely at the header and at the Main Control Board (PL 5.27). Do REP 1.5 to remove the Rear Cover to gain access to the connector at the Control Board. Refer to [GP 6.26](#) for termination locations.

**All the connectors are securely connected.**

**Yes-** Go to Step 3

**No-** Make the connection and resume operation

3. Check that the cable(s) connecting the Solenoid to the Main Control Board are intact. Refer to the solenoid cables table [GP 6.26](#) to identify the appropriate cable part numbers.

**The cables look okay**

**Yes-** Go to Step 4

**No-** Identify and replace the faulty cable

4. Do 6.3.5 [FIRMWARE UPGRADE Procedure](#) to Re-flash the firmware for the eWire

**This clears the fault**

**Yes-** Return to normal operation

**No-** Go to Step 5

5. Replace 7718113 Deflector Solenoid Linkage, refer to REP 5.6

**This clears the fault**

**Yes-** Return to normal operation

**No-** Go to Step 6

6. Do *REP 11.1 Main Control Board A Replacement*.

**This clears the fault**

**Yes-** Return to normal operation

**No-** Escalate to second level

### GP 6.6.3 Check L6 and L7 Vacuum Module Solenoids

#### To access Solenoids L6 and L7:

- Raise the top cover by releasing the latch
- To test Solenoid L6, raise the Vacuum Module by lifting the handle and tilting it back towards the infeed side of the eWire. L6 will activate the kick-down paddle.
- There are two L7 solenoids located on the front and rear of the vacuum module, refer to PL 5.14. To check L7, lower the Vacuum Module into its down position, and check that the kick down legs actuate when L7 is actuated.
- Insert a cheater into the interlock switch for the upper bypass assembly

#### WARNING

**Moving Parts, keep hands clear of moving parts when the Interlock Cheater is inserted. See Section 0, page vii for other languages.**

1. Do GP 6.3.2 [SOLENOIDS Procedure](#) to activate and deactivate Solenoids L6 and L7
  - The kick down runners (4 total) should cycle down when the L7 solenoids are cycled. Note that both the front and back L7 solenoids should cycle when activated. Kick down linkages will retract when the Vacuum Module is raised, so this is easiest to test in the down position.
  - The drag finger plate should advance when the solenoid L6 is activated. This is easiest to see when the Vacuum Module is in its raised position.

#### Linkages Move when L6 and L7 are cycled

**Yes-** Return to the RTP that directed you here  
**No-** Go to Step 2

2. Make sure the solenoid wire is connected securely at the header and at the Main Control Board (PL 5.27). Do REP 1.5 to remove the Rear Cover to gain access to the connector at the Control Board.

**All the connectors are securely connected.**

**Yes-** Go to Step 3

**No-** Make the connection and resume operation

3. Check that the cable(s) connecting the Solenoid to the Main Control Board are intact. Refer to the solenoid cables table to identify the appropriate cable part numbers, [GP 6.26](#).

#### The cables look okay

**Yes-** Go to Step 4

**No-** Identify and replace the faulty cable.

4. Do GP 6.3.5 [FIRMWARE UPGRADE Procedure](#) to Re-flash the firmware for the eWire

#### This clears the fault

**Yes-** Return to normal operation; **No-** Go to Step 5

5. Replace appropriate solenoids, refer to REP 4.2 Solenoid Replacement, Kickdown Solenoid, Rear (L7), REP 4.2 Solenoid Replacement, Kickdown Solenoid, Front (L7), and REP 4.3 Solenoid Replacement Drag Finger Solenoid (L6).

- 7718112, Kick Down Solenoid Assembly
- 7715289, Drag Finger Solenoid

#### This clears the fault

**Yes-** Return to normal operation

**No-** Go to Step 6

6. Replace the Vacuum Module Assembly 7716805 (refer to REP 4.1)

#### This clears the fault

**Yes-** Return to normal operation

**No-** Go to Step 7

7. Do *REP 11.1 Main Control Board A Replacement*, or *REP 11.2 Main Control Board B Replacement*

#### This clears the fault

**Yes-** Return to normal operation

**No-** Escalate to second level



### GP 6.6.4 Check L8 Holder Lock Solenoid

#### To access Solenoid L8:

- Open and close the Top Cover to home the Holder Module.
- There are two L8 solenoids located on the Holder Module, refer to PL 5.22.
- Insert a cheater into the Top Cover Interlock.



#### **WARNING**

**Moving Parts, keep hands clear of moving parts when the Interlock Cheater is inserted. See Section 0, page vii for other languages.**

1. Do 6.3.2 [SOLENOIDS Procedure](#) to activate and deactivate Solenoid L8
  - Unplug one solenoid and perform the check, then plug that solenoid back in and unplug the other and repeat the check. The plugged in solenoid in either case should still trigger even if it doesn't move the holder. Plug both back in.
  - The holder lock mechanism should cycle closed and open when L8 is activated
  - Note that both the front and back solenoids should cycle when activated

**Holder Lock mechanism cycles forward and back when L8 is cycled**  
**Yes-** Return to the RTP that directed you here;  
**No-** Go to Step 2
2. Make sure the solenoid wire is connected securely at the header and at the Main Control Board (PL 5.27). Do REP 1.5 to remove the Rear

Cover to gain access to the connector at the Control Board. Refer to GP 6.26 for termination locations.

**All the connectors are securely connected.**

**Yes-** Go to Step 3;

**No-** Make the connection and resume operation

3. Check that the cable(s) connecting the Solenoid to the Main Control Board are intact. Refer to the solenoid cables table to identify the appropriate cable part numbers, refer to [GP 6.26](#).

**The cables look okay**

**Yes-** Go to Step 4;

**No-** Identify and replace the faulty cable

4. Do GP 6.3.5 [FIRMWARE UPGRADE Procedure](#) to Re-flash the firmware for the eWire

**This clears the fault**

**Yes-** Return to normal operation;

**No-** Go to Step 5

5. Replace 7717746 Holder Lock Solenoid L8, refer to REP 8.19

**This clears the fault**

**Yes-** Return to normal operation;

**No-** Go to Step 6

6. Replace 7716612 Holder Lock Assembly, refer to REP 8.17 Holder Lock Sub-Assembly Replacement

**This clears the fault**

**Yes-** Return to normal operation;

**No-** Go to Step 7

7. Do REP 11.3 *Main Control Board B Replacement*.

**This clears the fault**

**Yes-** Return to normal operation;

**No-** Escalate to second level

### GP 6.6.5 Check L9 Book Eject Solenoid

#### To access Solenoid L9:

- Raise the Top Cover by releasing the latch.
- Solenoid L9 is located inside the Closer Module.

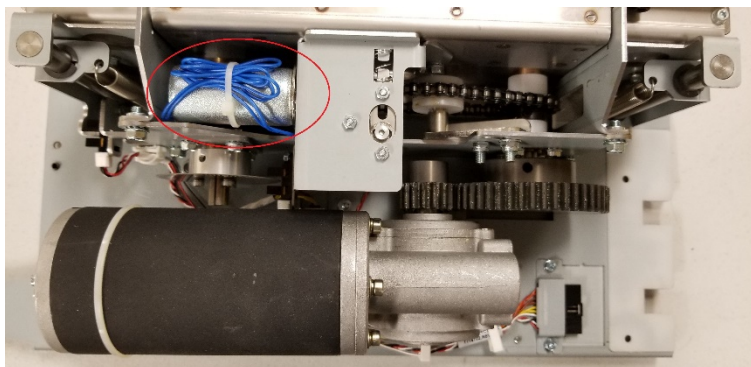

- Insert a cheater into the Top Cover Interlock.

#### WARNING

**Moving Parts, keep hands clear of moving parts when the Interlock Cheater is inserted. See Section 0, page vii for other languages.**

1. Do GP 6.3.2 [SOLENOIDS Procedure](#) to activate and deactivate Solenoid L9.
  - The Pusher Plate should move out when solenoid L9 is activated.

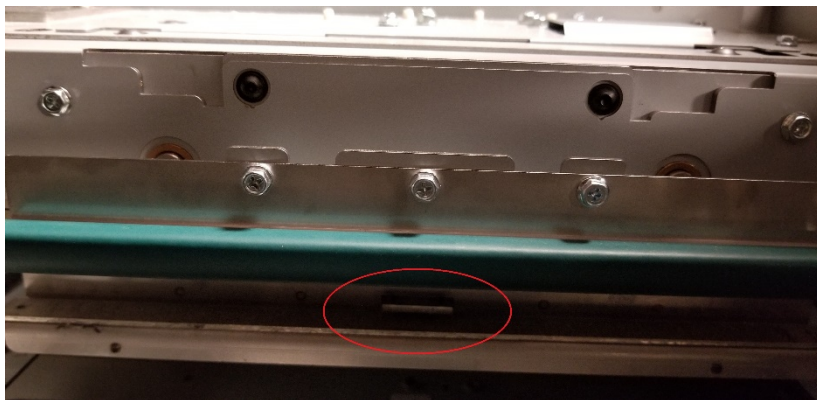

#### Pusher Plate moves out when L9 is activated.

**Yes-** Return to the procedure that directed you here ;  
**No-** Go to Step 2

2. Follow REP 6.1 to remove the Cable Access Cover. Check that the Flat Mylar Closer Cable is plugged in and properly seated in its housing as shown.

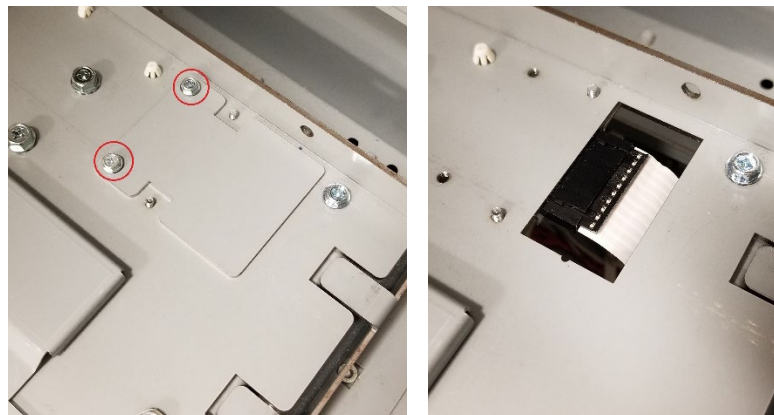

#### Cable is plugged in and properly seated

**Yes-** Go to Step 3;

**No-** Plug in the cable and cycle the Element Feeder Door interlock.

#### The Pusher Plate moves out when L9 is activated.

**Yes-** Reinstall the Cable Cover and return to the procedure that directed you here;

**No-** Go to Step 3.

3. Do REP 6.4 to remove the Closer Motor. Make sure that both ends of the solenoid wire are connected securely at the header and at the Main Control Board (PL 5.27). Do REP 1.5 to remove the Rear Cover to gain access to the connector at the Control Board. Refer to [GP 6.26](#) for termination locations.

#### All the connectors are securely connected.

**Yes-** Go to Step 4;

**No-** Make the connection then reinstall the Closer Module.

#### The Pusher Plate moves out when L9 is activated.

**Yes-** Reinstall the Closer Motor and Cable Cover and return to the procedure that directed you here;

**No-** Go to Step 4

4. Check that the cable(s) connecting the Solenoid to the Main Control Board are intact. Refer to the solenoid cables table [GP 6.26](#) to identify the appropriate cable part numbers.

**The cables look okay**

**Yes-** Go to Step 5

**No-** Identify and replace the faulty cable then try activating L9

**The Pusher Plate moves out when L9 is activated.**

**Yes-** Reinstall the Closer Motor and Cable Cover and return to the procedure that directed you here;

**No-** Go to Step 5

5. Do 6.3.5 [FIRMWARE UPGRADE Procedure](#) to Re-flash the firmware for the eWire.

**This clears the fault**

**Yes-** Return to the procedure that directed you here;

**No-** Go to Step 6

6. Do REP 6.9 Book Eject Solenoid Replacement.

**Pusher Plate moves out when L9 is activated.**

**Yes-** Return to the RTP that directed you here;

**No-** Go to Step 7

7. Do REP 11.2 Main Control Board B Replacement.

**Pusher Plate moves out when L9 is activated.**

**Yes-** Return to the RTP that directed you here;

**No-** Escalate to second level

**GP 6.7 Supply Spool Installation**

Do the following procedure to install a new supply spool into the eWire. If you need to remove a spool that is not yet empty first, first do GP 6.8.

1. Stop the Printer/Copier. Open the eWire access door panel and slide the Element Feeder Drawer out.
2. If applicable, go to GP 6.8 to remove the previously installed element spool.
3. Remove the wire shield. Pull on the wire shield handle to remove the entire shield, and place the shield safely on top of the element feeder.



4. Remove the spool retainer from the spindle. Turn the knob counter clockwise until the cap can be removed, and set it aside.



5. Remove the Supply Spool from its carton and remove the plastic shrink wrap.

Method 1: Remove the plastic by cutting across using scissors.

**Caution:** Do not cut the carrier paper or wire when cutting the plastic, doing so may ruin the spool.



Method 2: With the plastic still on the Supply Spool proceed to Steps 8 & 9 before slowly unwinding it.



**Note:** Do not remove the cardboard retainer at this point. The wire will unwind if it is not secured throughout the process and may lead to jams.

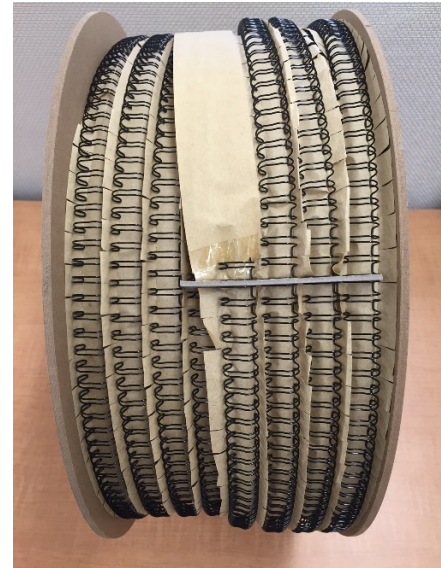

6. Install the spool by sliding the spool onto the hub. The circular barcode label must face towards the inside of the machine. The product description label on the hub must face out.

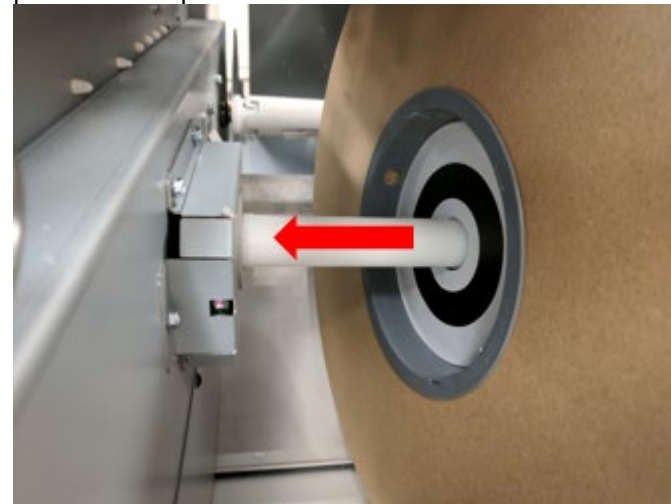

7. Secure the spool by using the spool retainer. Turn the knob clockwise to thread the cap into the spindle until spool is secure. Do not over tighten
8. Gently remove the flat cardboard spacer that is used to secure the wire during shipment. Before removing the spacer, check that the flexible magnet is installed to secure the wire.



9. Pull the wire and paper away from the spool and hold them both in one hand. With your free hand install the wire shield.



10. While still holding the carrier paper, use the magnetic catch to hold the wire.



11. Lift the metal guide of the shield and slide the carrier paper between it and the lower bars.



12. Attach the end of the carrier paper to the rewind spool. Leave 1-2in (2.5-5cm) of excess and fold that back on top of the metal clip.

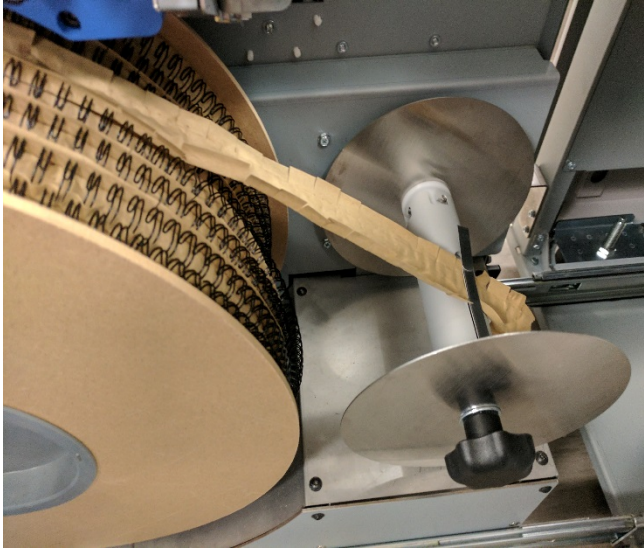

13. Turn the rewind spool clockwise until you have enough wire to reach the blue wire guide. Slide the wire onto the plastic wire guide and feed it into the plastic sprocket. Use the knob to manually turn the plastic sprocket and aid wire installation.



14. Adjust the wire end position by using the knob attached to the wire feed sprocket. The wire end should line up in the window on the blade guard. The wire end should line up with the transition line between the blue wire guide and the grey anvil.



15. Confirm that the spool is installed properly.
  - a. Is the rewind paper secured to the Rewind Hub and taut?
  - b. Is the wire fed loosely across the wire shield?
  - c. Is there one row of slack wire beneath the spool, in contact with the bottom of the Element Feeder Drawer?
  - d. Is the end of the wire in line with the mark on the Element Guide Nose, just in front of the Knife?
  - e. Is all the spool packaging and the flexible magnet removed?

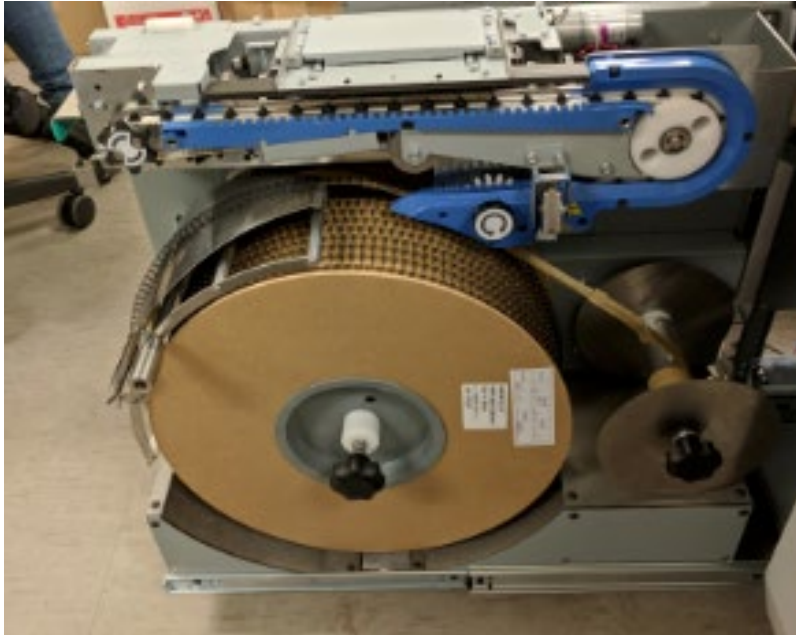

16. Slide the Element Feeder Drawer back into the eWire and close the door.

### **GP 6.8 Supply Spool Removal**

Do the following procedure to remove a partially full supply spool from the eWire. If the spool is empty, the same general procedure can be used but there is no need secure loose wire to the spool.

1. Stop the Printer/Copier. Open the eWire access door panel and slide the Element Feeder Drawer out.
2. Turn the Knob counterclockwise to release the wire loose end from the Element Feeder.

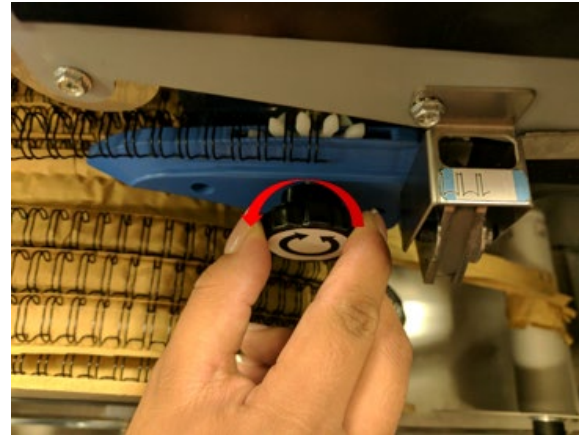

3. Lift slack wire from the metal wire guide surface and place it against the magnetic catch. This will hold wire out of the way during replacement.

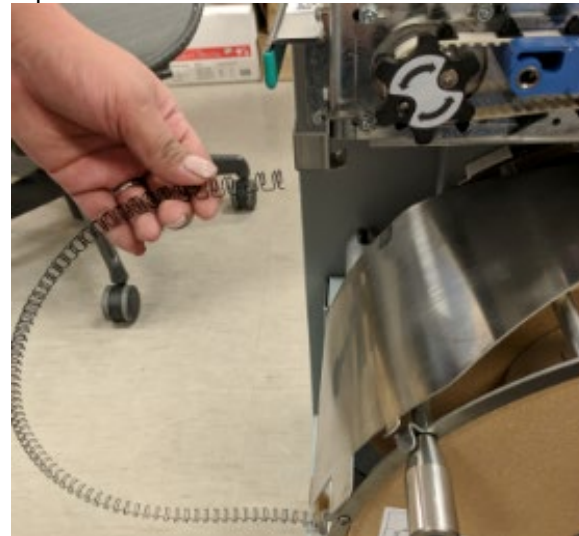

4. Turn the rewind spool counterclockwise to generate slack in the carrier paper.



5. Lift the metal wire guide on the shield and pull the carrier paper out from the shield. Then remove the wire shield. Pull on the wire shield handle to remove the entire shield, and place the shield safely on top of the element feeder.



6. Rewind the spool counterclockwise to take the excess slack from the wire and the paper.



7. Take the wire off the magnet and place it on the empty carrier paper you rewound. Pull the wire toward the rewind spool making sure to take up all of the slack. Ensure that the wire you are placing back on the spool is contained in the paper you are rewinding and does not interfere with the other rows of wire





8. Secure the wire using a magnet as shown. Repeat steps 4 and 6 until all the wire is on the spool.

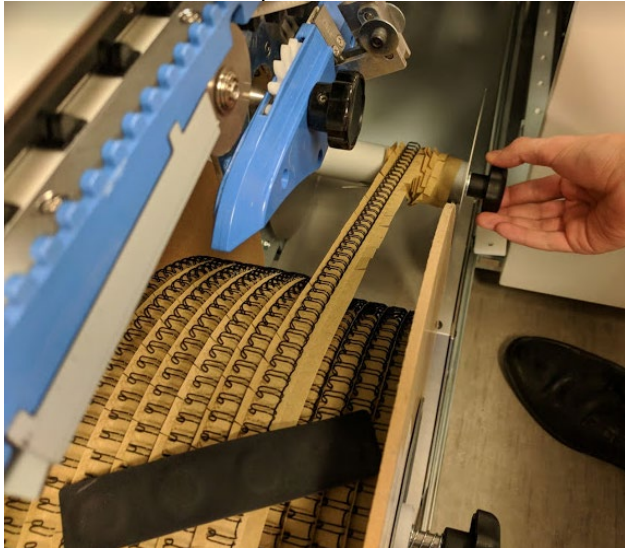

9. Secure the wire rows on the spool at the end of the loose wire using the 2<sup>nd</sup> magnet strip, then move the first magnet strip you placed as shown here. Place the magnets across rows of wire so that the loose end of wire is secured to the wound rows. The magnets prevents the wire from slipping when the spool is removed.

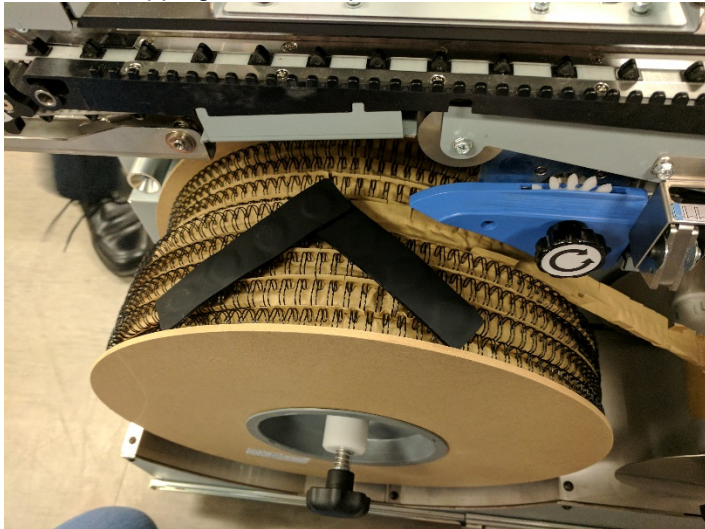

10. Tear the carrier paper where it leaves the rewind spool. Your carrier paper should extend about 12 inches (30 cm) beyond the loose end of your wire.



11. Unscrew the spool retainer. Turn the knob counterclockwise to loosen and remove the cap. Set the cap aside.

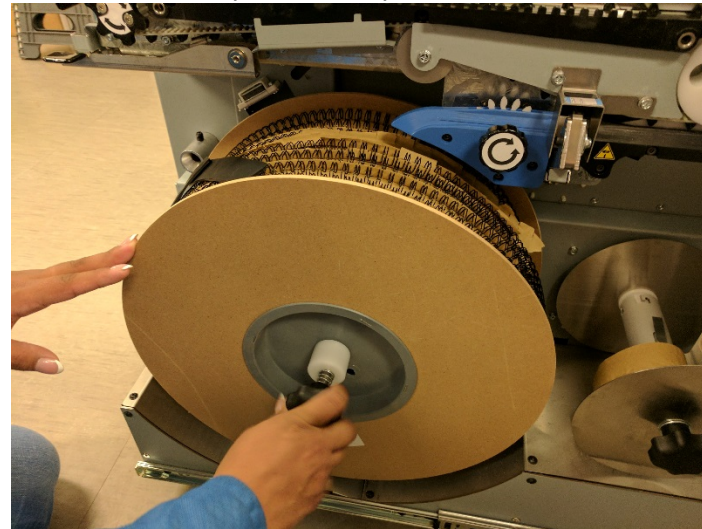

12. Remove the spool from the machine. Pull the spool straight away from the machine to slide it off the spindle. Properly store the spool for future use. Refer to [GP 6.9](#) for Spool Storage guidelines.

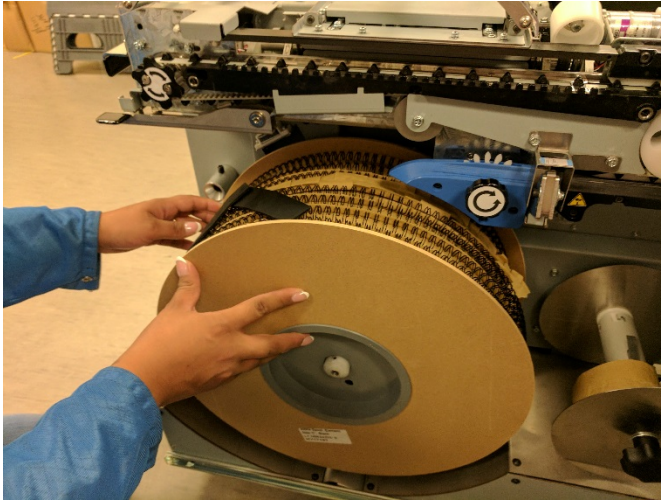

13. To remove the rewind spool from the feed spindle, push the hub in and turn it clockwise. Remove the excess paper by sliding it off the hub. If the rewind spool is full of paper, it may be difficult to remove. The spool must be pressed in firmly before rotating to disengage the pin. Reinstall the empty Paper Feed Hub onto the spindle.

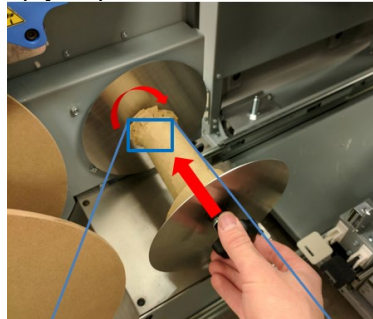

14. Open the top cover and identify the wire Holder. Check if there is a cut length of wire on the Holder (long boxed section). If there is, remove it by pressing the Holder release (small boxed sections) and remove the wire.

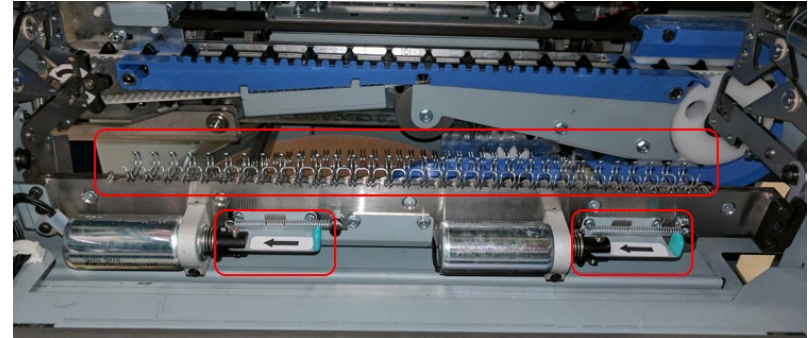

15. If a new supply spool is to be installed, refer to GP 6.7. If not, reinstall the Spool Holder Cap and Wire Guide for the next operation.  
16. Slide the Element Feeder Drawer back into the eWire and close the door.

### GP 6.9 Spool Storage

Always properly store the eWire Supply Spool when it is not in use. Unopened cartons should always be stored vertically as indicated on the spool packaging. Do not remove the packaging or shrink wrap until you are ready to use the spool.



2. Partially used spools must always be stored vertically.

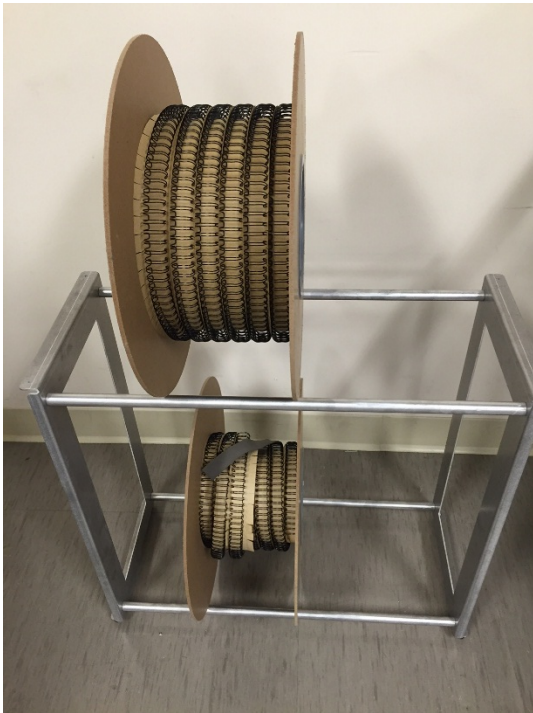

3. Never store the spool on its side, as wire twisting could occur



4. Do not store the magnet strips on the inside of the element feeder door when not in use, this can cause wire jams. Store the magnets as shown below on the element feeder drawer or away from the machine. When storing them on the element feeder, ensure that they are completely on the flat face of the drawer and are not near the spool.



Example of improper magnet storage:

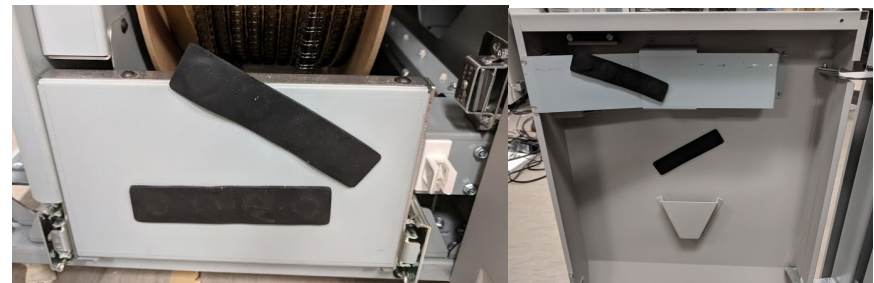

### **GP 6.10 Internal Inspection**

This section shows examples of good components and ones that are damaged and require replacement. Use this as a reference when performing inspections.

Before inspecting individual modules, do the following general inspection whenever the covers have been removed for corrective maintenance.

1. Visually inspect for defects and problems such as damaged components, loose screws or nuts, abraded wire insulation, loose terminals, etc.
2. Correct any problems before returning the machine to service.

### **Drag Finger and Closer Pusher**

Inspect the green coverings of the drag finger and pusher plate for toner or paper dust build up. If there is a buildup on either of these parts clean them with a cloth and alcohol.

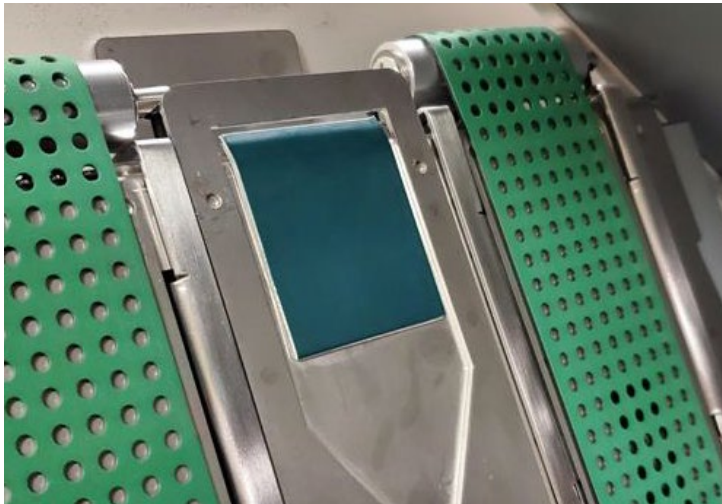

### **Stacker Module Green Belt**

Inspect the green belt on the vacuum staker for tears and paper dust coating. Dust coatings will appear as a white tint on the belt and can be cleaned with a cloth and alcohol.

Rotate the belt by hand inspecting it for tears. If any tears are present, replace the belt. Below is an example of a clean undamaged belt.

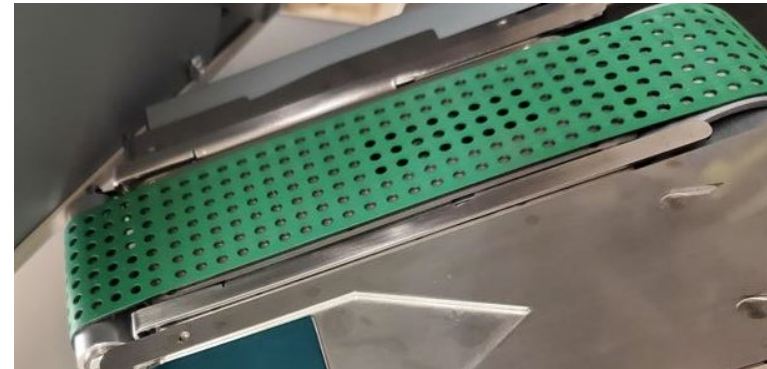

### **Idler Rollers**

Inspect the rollers for seizing and toner build up.

The idler rollers should spin freely without stuttering. The rollers should rotate when touched when they are not engaged with a drive roller. If they do not rotate freely, they should be replaced.

Dark marks shown below are an indication that the roller has seized and requires replacement.



Toner residue can build up and can be cleaned with a cloth and alcohol. Toner appears as a tint on the rollers. Toner residue is unrelated to seized rollers and is not indicative of a problem.

## Steering Rollers

Inspect the steering rollers for damage.

Replace the rollers if the rubber portion is broken or missing sections. When inspecting the rollers also check that the tension of the belt is properly set.

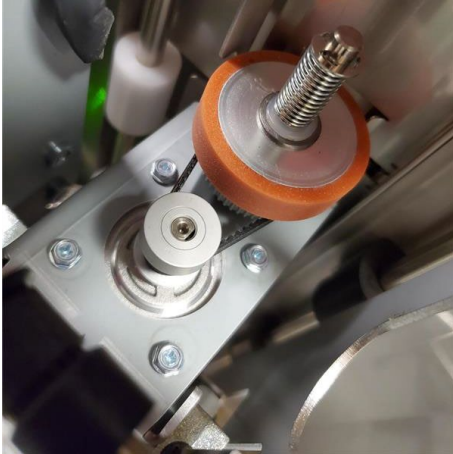

## Element Feed Belt

Inspect the belt for damaged or missing teeth. Check each tooth for damage. The element feed belt should be replaced when a broken tooth is present. A broken tooth is any tooth that is missing a piece. Teeth break and crack as the result of wire jams.

If teeth are cracked but not broken, the belt does not need immediate replacement but should be monitored. Below is an example of a cracked tooth.



## Kick Downs

Inspect the kickdowns for damage.

The kickdowns should be free of bends. The flat sanction should be straight and parallel to the green belts. All kickdowns should be the same length. Kick downs should be replaced if they are bent or broken. Attempting to bend a kickdown into shape will result in a failure shortly after.

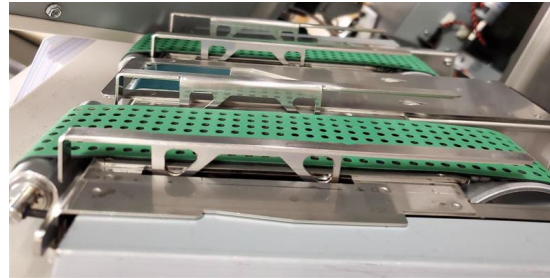

## Closer Jaw Plates

Closer jaw plates should be replaced every 50,000 books or when the machine has closing issues that cannot be resolved through adjustments. Use the information below to determine if the jaws need to be replaced early.

The surface of the closer jaws will naturally discolor as a result of the wire element coating rubbing off onto the plates. This discoloration does not indicate a plate requires replacement.

The jaw surface can become damaged and lose its abrasive texture. This can cause issues with binding if present in enough locations on the jaw.

The area indicated by the arrow on the left is an instance of the abrasive surface rubbing off.

The area indicated by the arrow on the right is an example of the abrasive surface discoloring from the wire coating and should not cause performance issues.

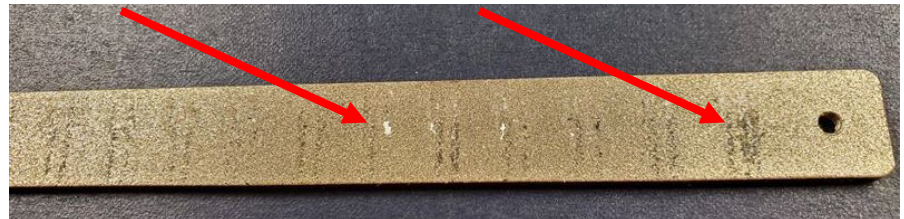

### GP 6.12 Internal Cleaning

Do the following to clean the interior of the eWire.

1. Open the doors and lid and remove paper dust and debris. Paper dust can accumulate throughout the machine including around the motors and other electrical components.
2. Use a vacuum cleaner if possible. A small paintbrush can also be used but extreme care should be used around electrical components.
3. Clean non-electrical components with alcohol, an approved cleaner, or a soft cloth moistened with mild detergent and warm water.
4. Clean the Rollers with alcohol.

**Warning:** Make sure you disconnect the eWire from its power source before cleaning. Failure to observe this warning could result in death or serious injury. See *Section 0, page vii for other languages*.

### GP 6.13 Base Cleaning

Use this procedure to clean the bottom of the Element Feeder Drawer. Excessive paper dust or other debris may interfere with the function of the S20 sensor.

**Warning:** Make sure you disconnect the machine from its power source before cleaning. Failure to observe this warning could result in death or serious injury. See *Section 0, page vii for other languages*.

### Maintenance Schedule

Clean if excessive debris or dust is seen in the vicinity, or if the S20 sensor appears not to be functioning correctly.

### Removal Procedure

1. Open the Element Feeder Door and slide out the Element Feeder Drawer.
2. Do GP 6.8 [Supply Spool Removal](#) to remove the Supply Spool and the Rewind Spool.
3. Remove the Spool Detect Cover by removing the M4 Screws (3).

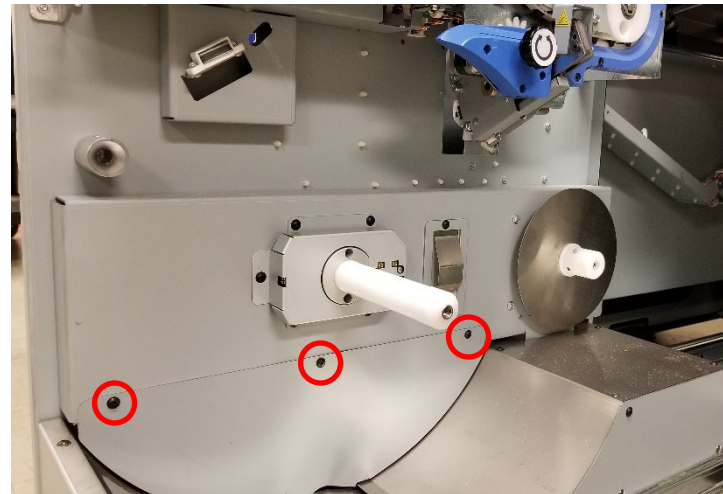

4. Remove the Rear Baffle by removing the M4 Screws (6)



#### Cleaning Procedure

Use a vacuum, compressed air, and/or a cloth to remove any paper, dust or other debris. Take care not to damage or dislodge the wire leading to the S20 sensor.

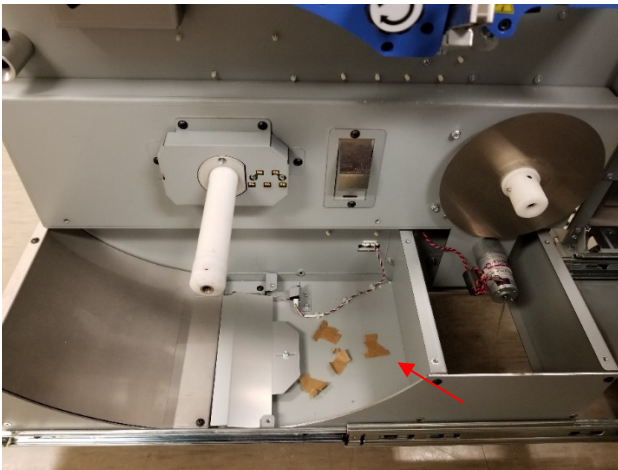

#### Installation Procedure

1. Reverse the steps in the Removal Procedure. **Caution:** Do not overtighten the button head screws.
2. Connect the Power Cord.
3. Power ON the eWire.

#### GP 6.14 Idler Roller and Idler Springs Inspection

Idler rollers press against the drive rollers and move the paper through the eWire.

#### Maintenance Schedule

Inspect and clean every 1 million sheets.

#### Procedure

1. Inspect the rollers for wear, debris, toner marks, unevenness, and dents.
2. Inspect springs (2) for each Idler Roller, and make sure they are correctly hooked.
3. Inspect the Bearing Housing. The Bearing Housing should slide freely in the Bearing Forks.

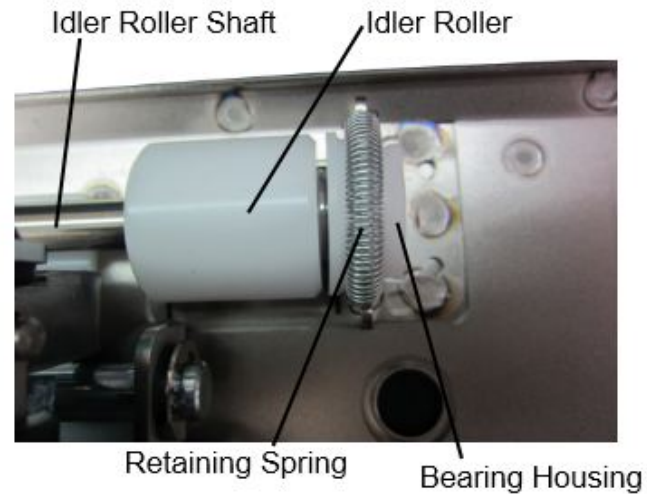

### **GP 6.14.1     Roller Cleaning**

Use this procedure to clean the Rollers.

#### **Maintenance Schedule**

Inspect and clean every 1 million sheets.

#### **Procedure**

1. Do REP 2.4 or REP 2.5 *Idler Roller Replacement* to remove the Idler Roller.
2. Clean the Idler Rollers with a soft cloth and alcohol.
3. Inspect rollers for wear patterns or groves. The roller surface should be smooth. See GP 6.10
4. Ensure the rollers turn freely on the shaft and that the idler roller shaft "floats" freely in the bushing forks.
5. Do REP 2.4 or REP 2.5 *Idler Roller Replacement* to re-install the Idler Roller.

### **GP 6.15   Optical Sensor Cleaning**

Do the following procedure to inspect and clean the Optical Sensors.

If necessary, refer to GP 6.4 [Sensor Checks](#) to locate and verify function of the sensors.

**Warning:** Make sure you disconnect the machine from its power source before cleaning. Failure to observe this warning could result in death or serious Injury. See *Section 0, page vii for other languages.*

#### **GP 6.15.1   Optical Reflectance Sensor Cleaning**

Do the following procedure to inspect and clean the Optical Sensors. Clean the Optical Sensors if excessive debris or dust is seen in the vicinity, or if there is a possible issue with the function of the sensor.

#### **Maintenance Schedule**

Clean if excessive debris or dust is seen in the vicinity, or if the sensor appears not to be functioning correctly.

#### **Procedure**

1. Use compressed air to blow the debris off each sensor. If necessary, use a pre-moistened, alcohol free, anti-static wipe to carefully clean the surface of the sensor. The following illustration shows an example of the sensor.





### GP 6.15.2 Optical Through Beam Sensor Cleaning

Do the following procedure to inspect and clean the Optical Sensors. Clean the Optical Sensors if excessive debris or dust is seen in the vicinity, or if there is a possible issue with the function of the sensor.

#### Maintenance Schedule

Clean if excessive debris or dust is seen in the vicinity, or if the sensor appears not to be functioning correctly.

#### Procedure

1. Use compressed air to blow the dust and/or debris off each sensor. The following illustration shows an example of the sensors.

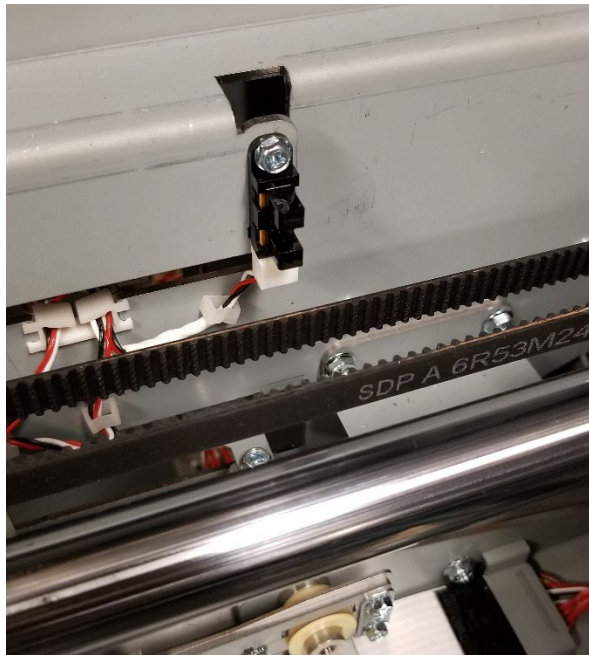

### GP 6.15.3 Alignment and Skew Sensor Cleaning

Do the following procedure to inspect and clean S6 – S15.

#### Maintenance Schedule

Inspect and clean every service call.

#### Procedure

1. Open the Top Cover
2. Remove the M3 screws (4) holding the Idler Steering Panel. Take care to secure the spacers (2) between the two panels.



3. Using compressed air, blow any dust or debris out of the slot between the two LEDs on each sensor.

- Using a pre-moistened, alcohol free, anti-static wipe, gently wipe the surface of each LED to remove the film of paper dust.

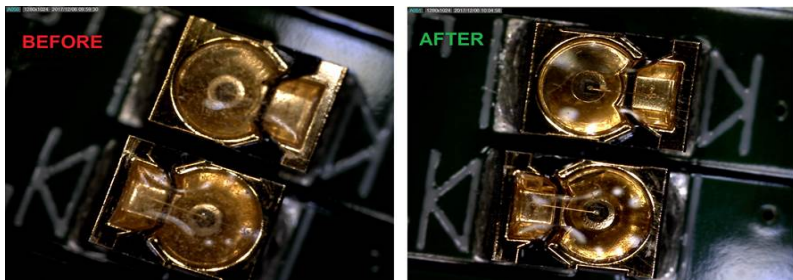
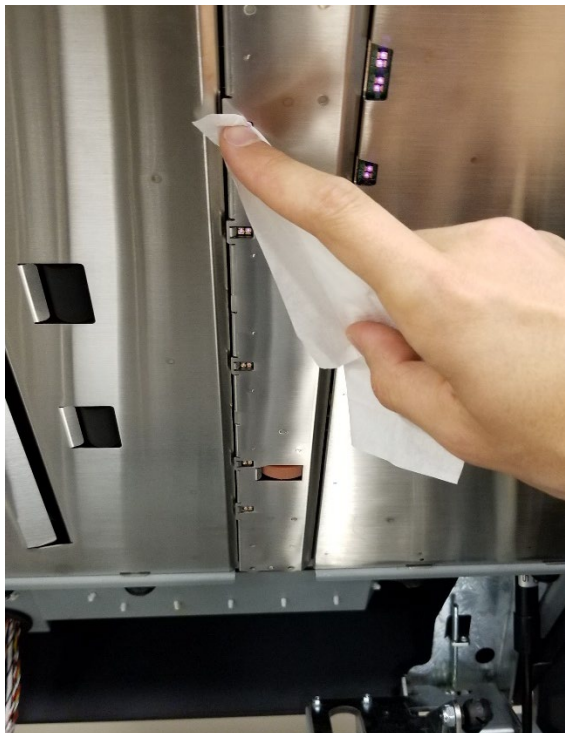

- Reinstall the Idler Steering Panel and the M3 screws (4).

#### **GP 6.15.4 Spool Detect & Near Empty Sensor Cleaning**

Do the following procedure to inspect and clean S26 – S30, and S50.

#### **Maintenance Schedule**

Clean if excessive debris or dust is seen in the vicinity, or if the sensors appear not to be functioning correctly.

#### **Procedure**

- Do GP 6.8 [Supply Spool Removal](#) to remove the Supply Spool.
- Using a pre-moistened, alcohol free, anti-static wipe, gently wipe the surface of each LED to remove the film of paper dust.

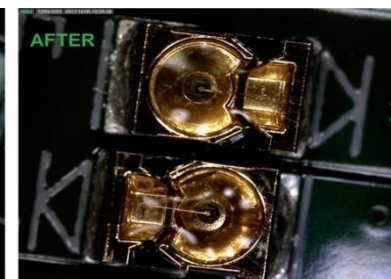
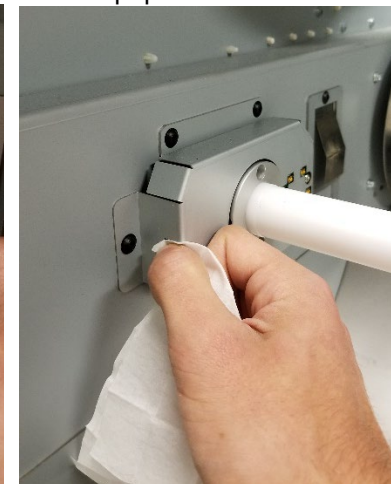

### GP 6.15.5 S22 Film Cleaning

Do the following procedure to inspect and clean the transparent film between the emitter and receiver of the S22 sensor.

#### Maintenance Schedule

Inspect and clean every service call.

#### Procedure

1. Use a cloth to remove any dust from the film.

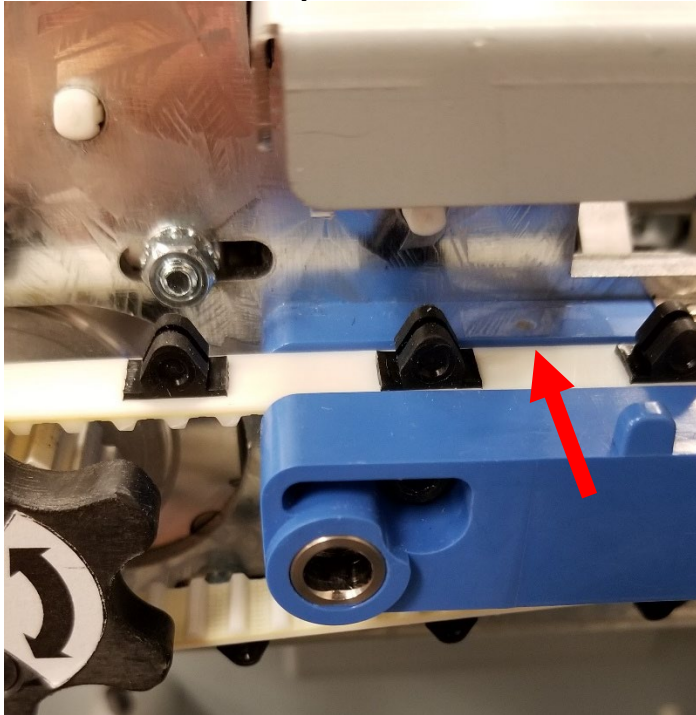

### GP 6.16 Bypass Paper Path Inspection and Cleaning

Do the following to inspect and clean the Bypass Paper Path.

**Warning:** Make sure you disconnect the machine from its power source before cleaning. Failure to observe this warning could result in death or serious injury. See Section 0, page vii for other languages.

1. Open the top cover and raise the Upper Bypass to access the Bypass Paper Path.
2. Inspect the Bypass panel, rollers, and entrance guide for wear, damage, and obstructions.
3. Inspect the rollers for wear patterns or groves. The roller surface should be smooth and even. Make sure the rollers are clean. Clean rollers with a soft cloth and alcohol.
4. Inspect the polished metal surfaces on the Upper Bypass and Lower Bypass. Ensure the surface is smooth and free of debris. Clean the Upper Bypass and Lower Bypass plates with a cloth and alcohol.
5. Ensure the bypass diverter moves freely and returns to the bypass position.

### **GP 6.17 Timing Belt Inspection**

Use the following procedure to inspect the Timing Belts throughout the eWire. Inspect the Timing Belts if excessive wear or debris is observed, or if the function of the components driven by the belt appears to be compromised. Black dust around the area of a Timing Belt or frayed edges could indicate that the Belt is close to failure.

**Warning:** Make sure you disconnect the machine from its power source before cleaning. Failure to observe this warning could result in death or serious injury. See *Section 0, page vii for other languages*.

#### **Procedure**

Do the following to inspect the Timing Belts.

1. Inspect all timing belts for wear, missing teeth, frayed edges, and cracks.
2. For replacement, refer to the heading for the appropriate module in Section 4, Replacement Procedures.
3. Check for proper deflection of belts. The belts should be slightly loose with approximately 1/4" deflection when pressed.
4. Belts that are too loose will not drive properly and belts that are too tight can wear out prematurely or damage their driven components.
5. If the Belt has a Tensioner along the length of the Belt, the tension can be adjusted by loosening the screws on the Tensioner, and adjusting the Tensioner position until the proper tension is achieved.

### **GP 6.18 Solenoid Cleaning and Inspection**

**Warning:** Make sure you disconnect the machine from its power source before cleaning. Failure to observe this warning could result in death or serious injury. See *Section 0, page vii for other languages*.

Do the following to inspect and clean the Solenoids every 1 million sheets.

8. Clean the solenoid and surrounding area with a vacuum cleaner and canned air.
2. Make sure the solenoid is clean and dry.
3. Inspect for dirt or obstructions, wear or a damage spring.
4. Inspect and ensure the Solenoid linkage moves freely. Press linkage down and release. Linkage should return.
5. If necessary, refer to GP 6.3.2 to test the function of the Solenoid.

**Note:** Do not apply lubricants to the solenoid or linkage.

### **GP 6.19 Drawer Slide Rails Cleaning**

Do this procedure to clean the Drawer Slides that are used with the Element Feeder and Book Tray.

**Warning:** Make sure you disconnect the machine from its power source before cleaning. Failure to observe this warning could result in death or serious injury. See *Section 0, page vii for other languages*.

#### **Preventative Maintenance:**

Do this every 1 million sheets.

#### **Procedure**

1. Use a can of compressed air to remove dust from the alignment carriage rails. The carriage can be moved back and forth on the rails to clean the entire surface. Alternately, a soft cloth and alcohol can be used.
2. If necessary, the drawer can be removed from the rails by releasing the plastic catch on the side of the rail.
3. Slide the drawer in and out to ensure the drawer moves freely with no obstructions or excessive drag.

Important Note: DO NOT use any lubricant on the rails

### **GP 6.20 Diverter Solenoid Assembly Inspection**

Use this procedure to inspect the Diverter Solenoid Assembly every 1 million sheets.

**Warning:** Make sure you disconnect the machine from its power source before cleaning. Failure to observe this warning could result in death or serious injury. See *Section 0, page vii for other languages*.

1. Disconnect the Power Cord.
2. Do REP 1.1 to remove the Top Cover.
3. Clean the Solenoid and surrounding area with a vacuum cleaner and canned air. Refer to PL 5.3
4. Make sure the solenoid is clean and dry.
5. Raise the Diverter Solenoid by hand and release it. The Diverter should fall freely. Make sure the linkage operates smoothly.
6. Do GP 6.3.2 [Solenoids Procedure](#) to activate and deactivate Solenoid L1.

The diverter gate should rise and fall when L1 is cycled.

**GP 6.21 List of Sensors**

The table below lists all of the Sensors located in the eWire. Sensors are indicated by number and by description. For additional information, refer to Section 7 Wiring.

SENSOR	PART NO	DESCRIPTION	LOCATION
S1	7715193	BYPASS ENTRY SENSOR	UPPER TRANSPORT
S2	7715193	DEFLECTOR, KICK DOWN ACTUATOR	DEFLECTOR
S3	7715193	DEFLECTOR, ACTUATOR SENSOR	DEFLECTOR
S4	7715193	SENSOR, BYPASS CENTER	UPPER TRANSPORT
S5	7715193	SENSOR, BYPASS CENTER	UPPER TRANSPORT
S6	7715037	SKEW BOARD, SENSOR 1	UPPER TRANSPORT
S7	7715037	SKEW BOARD, SENSOR 2	UPPER TRANSPORT
S8	7715037	SKEW BOARD, SENSOR 3	UPPER TRANSPORT
S9	7715037	SKEW BOARD, SENSOR 4	UPPER TRANSPORT
S10	7715037	SKEW BOARD, SENSOR 5	UPPER TRANSPORT
S12	7715694	SENSOR ALIGNMENT 1	UPPER TRANSPORT
S13	7715694	SENSOR ALIGNMENT 2	UPPER TRANSPORT
S15	7715694	SENSOR ALIGNMENT 3	UPPER TRANSPORT
S16	7715193	SENSOR, BYPASS EXIT	UPPER TRANSPORT
S18	7715340	SENSOR, TAPPER HOME, FRONT	TAPPERS
S19	7715340	SENSOR, TAPPER HOME, REAR	TAPPERS
S20	7715340	SENSOR, ELEMENT SLACK	ELEMENT FEEDER
S21	7714775 & 7714776	SENSOR, ELEMENT DETECT AT KNIFE	ELEMENT FEEDER
S22	7714775 & 7714776	SENSOR, ELEMENT DETECT AT PYR	ELEMENT FEEDER
S23	7715340	SENSOR, KNIFE HOME	ELEMENT FEEDER
S24	7715340	SENSOR, PUSHOVER HOME	EXPANDING T
S25	7714775 & 7714776	SENSOR, BELT HOME	ELEMENT FEEDER
S26	7717206	SENSOR, SPOOL DETECT 1	ELEMENT FEEDER
S27	7717206	SENSOR, SPOOL DETECT 2	ELEMENT FEEDER

S28	7717206	SENSOR, SPOOL DETECT 3	ELEMENT FEEDER
S29	7717206	SENSOR, SPOOL DETECT 4	ELEMENT FEEDER
S30	7717206	SENSOR, SPOOL DETECT 5	ELEMENT FEEDER
S31	7715340	SENSOR, PUSHOVER ENCODER	EXPANDING T
S32	7715340	SENSOR, EXPANDING T HOME	EXPANDING T
S33	7715340	SENSOR, EXPANDING T OUT	EXPANDING T
S34	7715340	SENSOR, HOLDER ROTATE VERTICAL	HOLDER
S35	7715340	SENSOR, HOLDER ROTATE HORIZONTAL	HOLDER
S36	7715340	SENSOR, HOLDER POSITION CLOSER	HOLDER
S37	7715340	SENSOR, HOLDER POS AT STACK	HOLDER
S38	7715340	SENSOR, HOLDER POS AT ELEMENT	HOLDER
S39	7715340	SENSOR, DETECT AT REVERSE GATE	HOLDER
S40	7715340	SENSOR, HOLDER POS AT FEEDER	HOLDER
S41	7715340	SENSOR, ALIGN HOME	UPPER TRANSPORT
S42	7711970 & 7711973	SENSOR, BOOK DRAWER FULLL UP	BOOK DRAWER
S43	7715193	SENSOR, BOOK DRAWER FULL DOWN	BOOK DRAWER
S44	7715193	SENSOR, BOOK DRAWER PAPER DETECT	BOOK DRAWER
S46	7715340	SENSOR, CLOSER MECH HOME	CLOSER
S47	7715340	SENSOR, CLOSER FULL OPEN	HOLDER
S48	7715340	SENSOR, CLOSER ENCODER	CLOSER
S49	7715340	SENSOR, CLOSER STAGED	HOLDER
S50	7717479	SENSOR, SPOOL NEAR EMPTY	ELEMENT FEEDER

**GP 6.22 Sensor Connections**

The table below lists the cable connections for each Sensor located in the eWire. The Sensor Cable column indicates the cable that connects directly to the sensor. The Final Termination Column indicates the location of the sensor signal on the Main PCB, A or B board. The Internal Cable column lists any cables that connect the sensor cable to the Main PCB. Some sensors have more than one intermediate cable.

SENSOR	SENSOR CABLE	INTERNAL CABLE #1	INTERNAL CABLE #2	INTERNAL CABLE #3	FINAL TERMINATION	TEST POINT LOCATION
S1	7723828	N/A	N/A	N/A	J7, A	AC, D7
S2	7723831	7717613	N/A	N/A	J3, A	AC, D2
S3	7723831	7717613	N/A	N/A	J3, A	AC, D2
S4	7723828	N/A	N/A	N/A	J7, A	AC, D7
S5	7723828	N/A	N/A	N/A	J7, A	AC, D7
S6	7716738	7723829	N/A	N/A	J14, A	AC, A4
S7	7716738	7723829	N/A	N/A	J14, A	AC, A4
S8	7716738	7723829	N/A	N/A	J14, A	AC, B4
S9	7716738	7723829	N/A	N/A	J14, A	AC, B4
S10	7716738	7723829	N/A	N/A	J14, A	AC, B4
S12	7716737	7723829	N/A	N/A	J14, A	AC, A5
S13	7716737	7723829	N/A	N/A	J14, A	AC, A5
S15	7716737	7723829	N/A	N/A	J14, A	AC, B5
S16	7723828	N/A	N/A	N/A	J7, A	AC, D7
S18	7716712	7717613	N/A	N/A	J3, A	AC, D2
S19	7716712	7717613	N/A	N/A	J3, A	AC, D2
S20	7716720	7716719	7716711	N/A	J9, B	B, C9
S21	7716704	7716720	7716719	7716711	J9, B	B, C9
S22	7716720	7716719	7716711	N/A	J9, B	B, D9
S23	7716704	7716720	7716719	7716711	J9, B	B, D9
S24	7717473	7717472	7716717	7716711	J9, B	B, D9
S25	7716720	7716719	7716711	N/A	J9, B	B, D9
S26	7716721	7716718	7716711	N/A	J9, B	B, E9

S27	7716721	7716718	7716711	N/A	J9, B	B, F9
S28	7716721	7716718	7716711	N/A	J9, B	B, F9
S29	7716721	7716718	7716711	N/A	J9, B	B, G9
S30	7716721	7716718	7716711	N/A	J9, B	B, F9
S31	7717473	7717472	7716717	7716711	J9, B	B, D9
S32	7717473	7717472	7716717	7716711	J9, B	B, E9
S33	7717473	7717472	7716717	7716711	J9, B	B, E9
S34	7716706	7717347	7716709	N/A	J12, B	B, E3
S35	7716706	7717347	7716709	N/A	J12, B	B, F3
S36	7716709	N/A	N/A	N/A	J12, B	B, F3
S37	7716709	N/A	N/A	N/A	J12, B	B, F3
S38	7716709	N/A	N/A	N/A	J12, B	B, F3
S39	7716709	N/A	N/A	N/A	J12, B	B, F3
S40	7716709	N/A	N/A	N/A	J12, B	B, E2
S41	7723829	N/A	N/A	N/A	J14, A	AC, B5
S42	7716732	7716731	7716730	N/A	J5, B	B,E2
S43	7716732	7716731	7716730	N/A	J5, B	B, S43
S44	7716732	7716731	7716730	N/A	J5, B	AC, D2
S46	7716703	N/A	N/A	N/A	J7, B	B, C7
S47	7716702	7717348	7716703	N/A	J7, B	B, D7
S48	7716702	7717348	7716703	N/A	J7, B	B, C7
S49	7716703	N/A	N/A	N/A	J7, B	B, C7
S50	7716721	7716718	7716711	N/A	J9, B	B, G9

### A-C Board Test Points

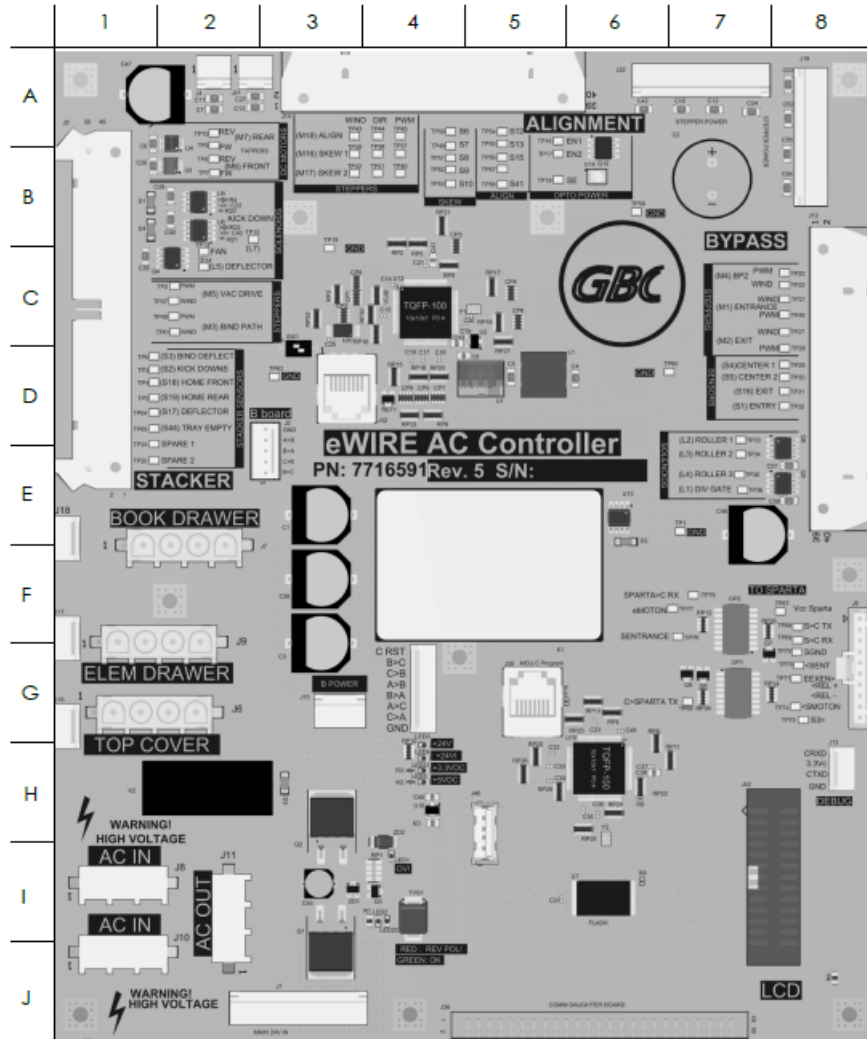

### B Board Test Points

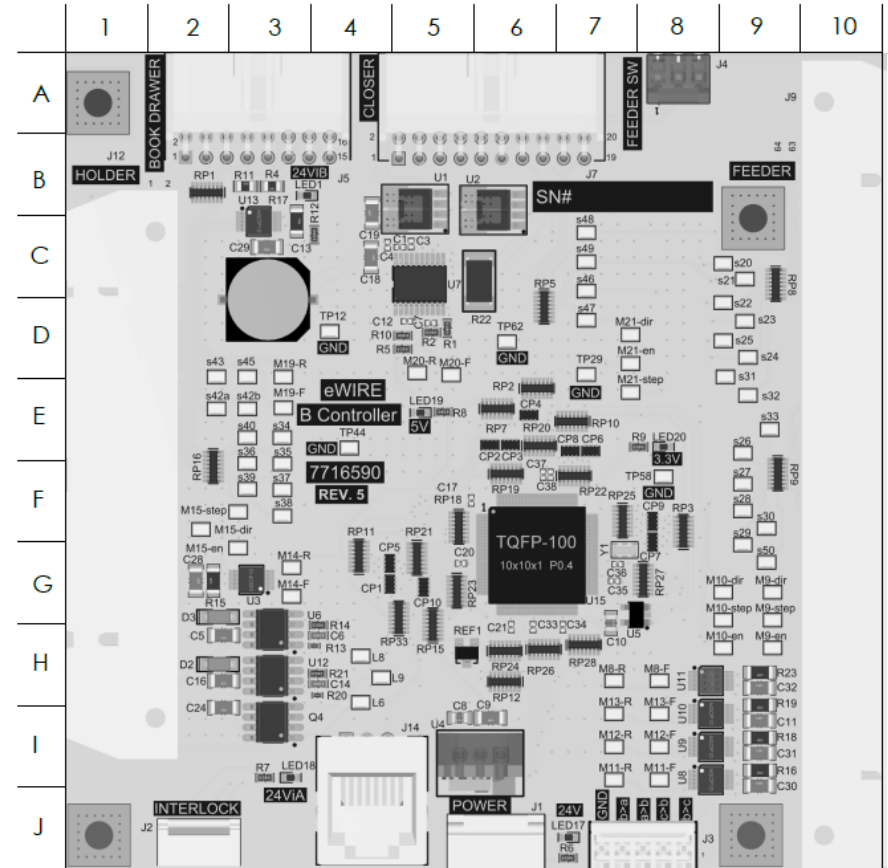



### GP 6.23 List of Motors

The table below lists all of the Motors located in the eWire. Motors are indicated by number and by description. For additional information, refer to Section 7 Wiring.

MOTOR	PART NO	DESCRIPTION	LOCATION
M1	7715200	MOTOR BYPASS 1	UPPER TRANSPORT
M2	7715200	MOTOR BYPASS 2	UPPER TRANSPORT
M3	7715337	MOTOR BIND PATH 1	DEFLECTOR
M4	7715337	MOTOR BAFFLE ROLLER STEPPER	PAPER TRANSPORT
M5	7715200	MOTOR VACUUM DRIVE	VACUUM STACKER
M6	7714769	MOTOR TAPPER, FRONT	TAPPERS
M7	7714769	MOTOR TAPPER, REAR	TAPPERS
M8	7714768	MOTOR SPOOL REWIND	ELEMENT FEEDER
M9	7715337	MOTOR ELEMENT FEED SPROCKET	ELEMENT FEEDER
M10	7715200	MOTOR ELEMENT FEED BELT	ELEMENT FEEDER
M11	7714770	MOTOR KNIFE	ELEMENT FEEDER
M12	7714768	MOTOR ELEMENT PUSHOVER	EXPANDING T
M13	7714772	MOTOR EXPANDING T	EXPANDING T
M14	7714768	MOTOR HOLDER ROTATE	HOLDER
M15	7715200	MOTOR HOLDER LINEAR	HOLDER
M16	7715337	MOTOR SKEW FRONT	UPPER TRANSPORT
M17	7715337	MOTOR SKEW REAR	UPPER TRANSPORT
M18	7715282	MOTOR SHEET ALIGN	UPPER TRANSPORT
M19	7714770	MOTOR DRAWER ELEVATION	BOOK DRAWER
M20	7714771	MOTOR ELEMENT CLOSER	CLOSER
M21	7715200	MOTOR CLOSER LINEAR	HOLDER

**GP 6.24 Motor Connections**

The table below lists the cable connections for each motor located in the eWire. The Motor Cable column indicates the cable that connects to the motor or driver board. Note that some stepper motors have separate signal paths for power and control signals. The Final Termination Column indicates the location of the motor connector on the Main PCB, A or B board. The Internal Cable column lists any cables that connect the sensor cable to the Main PCB. Some sensors have more than one intermediate cable.

MOTOR	MOTOR CABLE	INTERNAL CABLE #1	INTERNAL CABLE #2	INTERNAL CABLE #3	TERMINATION
M1	7723828	N/A	N/A	N/A	J12, A
	7723830	N/A	N/A	N/A	J22, A
M2	7723828	N/A	N/A	N/A	J12, A
	7716740	N/A	N/A	N/A	J4, A
M4	7723828	N/A	N/A	N/A	J12, A
	7723831	N/A	N/A	N/A	J22, A
M3	7717613	N/A	N/A	N/A	J3, A
	7716725	N/A	N/A	N/A	J19, A
M5	7717613	N/A	N/A	N/A	J3, A
	7716725	N/A	N/A	N/A	J19, A
M6	7716712	7717613	N/A	N/A	J3, A
M7	7716712	7717613	N/A	N/A	J3, A
M8	7716720	7716719	7716711	N/A	J9, B
M9	7716721	7716718	7716711	N/A	J9, B
	7716723	7716725	N/A	N/A	J19, A
M10	7716721	7716718	7716711	N/A	J9, B
	7716723	7716725	N/A	N/A	J19, A
M11	7716704	7716720	7716719	7716711	J9, B
M12	7717473	7717472	7716717	7716711	J9, B
M13	7717473	7717472	7716717	7716711	J9, B
M14	7716706	7717347	7716709	N/A	J12, B
M15	7716709	N/A	N/A	N/A	J12, B
	7716741	N/A	N/A	N/A	J21, A

M16	7717197	7723829	N/A	N/A	J14, A
	7723830	N/A	N/A	N/A	J22, A
M17	7717197	7723829	N/A	N/A	J14, A
	7723830	N/A	N/A	N/A	J22, A
M18	7717197	7723829	N/A	N/A	J14, A
	7723830	N/A	N/A	N/A	J22, A
M19	7716732	7716731	7716730	N/A	J5, B
M20	7716702	7717348	7716703	N/A	J7, B
M21	7716703	N/A	N/A	N/A	J7, B
	7716741	N/A	N/A	N/A	J21, A

**GP 6.25 List of Solenoids**

The table below lists all of the Solenoids located in the eWire. Solenoids are indicated by number and by description. For additional information, refer to Section 7 Wiring.

SOLENOID	PART NUMBER	DESCRIPTION	LOCATION
L1	7715336	SOLENOID, DIVERTER GATE	UPPER TRANSPORT
L2	7715289	SOLENOID, STEERING 1	UPPER TRANSPORT
L3	7715289	SOLENOID, STEERING 2	UPPER TRANSPORT
L4	7715289	SOLENOID, STEERING 3	UPPER TRANSPORT
L5	7715289	DEFLECTOR	DEFLECTOR
L6	7715289	SOLENOID DRAG FINGER	VACUUM STACKER
L7	7717746	SOLENOID KICK DOWN	VACUUM STACKER
L8	7717746	SOLENOID, HOLDER LOCK	HOLDER
L9	7715289	SOLENOID, CLOSER EJECT	CLOSER MODULE

**GP 6.26 Solenoid Connections**

The table below lists the cable connections for each Solenoid located in the eWire. The Solenoid Cable column indicates the cable that connects directly to the solenoid. The Final Termination Column indicates the location of the sensor signal on the Main PCB, A or B board. The Internal Cable column lists any cables that connect the solenoid cable to the Main PCB. Some solenoids have more than one intermediate cable.

SOL	CABLE	INTERNAL CABLE #1	INTERNAL CABLE #2	INTERNAL CABLE #3	TERMINATION
L1	7723828	N/A	N/A	N/A	J12, A
L2	7723828	N/A	N/A	N/A	J12, A
L3	7723828	N/A	N/A	N/A	J12, A
L4	7723828	N/A	N/A	N/A	J12, A
L5	7716700	7717613	N/A	N/A	J3, A
L6	7716701	7717613	7716709	N/A	J12, B
L7	7716701	7717613	N/A	N/A	J3, A
L8	7716706	7717347	7716709	N/A	J12, B
L9	7716703	7716702	N/A	N/A	J7, B

### **GP 6.27 Recommended Tool Kit**

Tools recommended for service of the eWire

#### **Standard Tools (metric)**

- 7mm Nut Driver
- 5.5mm Nut Driver
- 7mm Open End Wrench
- 5.5mm Open End Wrench
- 8mm Open End Wrench
- 10mm Open End Wrench
- Needle Nose Pliers
- Phillips Screwdriver
- Flathead Screwdriver
- Wire Cutters
- Metric Allen Key (1.5mm, 2mm, 2.5mm, 3mm, 4mm, 5mm, 6mm)

### **GP 6.28 Other Recommended Tools and Supplies**

- 0.25mm, 1mm, and 3mm Shim Gauges
- 0 to 2 kgf Force gage
- Loctite
- 150mm Metric ruler

### **GP 6.29 Cleaning Materials**

Use a clean, soft, lint-free cloth or a small paint brush to clean the following.

- GP 6.11, [External Cleaning](#)
- GP 6.12, [Internal Cleaning](#)

Use a soft cloth and alcohol to clean the following.

- GP 6.14.1 [Idler Roller Inspection and Cleaning](#)

Use canned air or soft cloth to clean the following

- GP 6.15.2, [Optical Though Beam Sensor Cleaning](#)
- GP 6.15.5, [S22 Film Cleaning](#)
- GP 6.19, [Slide Carriage Rails](#)

Use canned air or a vacuum cleaner to clean the following.

- GP 6.18, [Solenoid Cleaning and Inspection](#)

Use canned air and pre-moistened, alcohol free, anti-static wipes to clean the following

- GP 6.15.1, [Optical Reflectance Sensor Cleaning](#)
- GP 6.15.3, [Alignment and Skew Sensor Cleaning](#)
- GP 6.15.4, [Spool Detect and Spool Near Empty Sensor Cleaning](#)

Use canned air, a soft cloth or a vacuum cleaner to clean the following.

- GP 6.13, [Base Cleaning](#)

**GP 6.30 General Specifications**

<b>Speed</b>	Up to 140 sheets per minute	
<b>Bind Sheet Size and Edge</b> <b>LEF- Long Edge Feed</b>	<b>US Sizes</b> LTR LEF STMT LEF <b>ISO sizes</b> A4 LEF A5 LEF	
<b>Paper Stock</b>	Plain: 75gsm - 300gsm (20# bond to 110# cover)  Coated: 120gsm - 300gsm (32# bond to 110# cover)  Covers: 176gsm – 300gsm  Clear Cover: 7mil (Clear Covers should only be used for Front cover and not have print on it)	
<b>Tabbed Stock</b>	LTR – 3, 5, 8, 10 tabs A4 – 5, 10 tabs	
<b>Paper Bypass Mode Sheet size</b>	Paper sizes and stocks same as printer	
<b>Power Supply</b>	115V, 60Hz, Single Phase 230V, 50Hz, Single Phase	
<b>Electrical</b>	Amps and Frequency	115V; 2.8A; 60Hz 230V; 1.4A; 50Hz
<b>Safety Certification</b>	cULus, CE	
<b>Dimensions</b>	L: 31.7"; W: 35.9"; H: 42.5" L: 80.5cm; W: 91.1cm; H: 107.9cm	
<b>Weight</b>	226 kg (500 lbs)	
<b>Shipping Weight</b>	277 kg (610 lbs)	
<b>Manufactured</b>	Assembled in Taiwan	

## Section Contents

### Wiring Data

Title	Page
Cable Location Index .....	7-2
System Wiring .....	7-3
Element Feeder Module.....	7-4
Element Transfer Module.....	7-5
Knife Module .....	7-6
Closer Module .....	7-7
Holder Module.....	7-8
Book Drawer .....	7-9
Paper Transport Module .....	7-10
Sheet Tappers Module.....	7-11
Deflector Module.....	7-12
Stacker Module .....	7-13
Alignment Module .....	7-14
Interlock, AC, and LCD Connections .....	7-15

○ **Cable Location Index**

Cable #	Description	Location
7716700	WIRE HARNESS, SOL, DEFLECTOR MODULE	7-12
7716701	WIRE HARNESS, VACUUM STACKER INTERNAL	7-13
7716702	WIRE HARNESS, CLOSER MODULE INTERNAL	7-7
7716703	CABLE ASSY, PCB TO CLOSER	7-7
7716704	CABLE ASSY, KNIFE MODULE	7-6
7723833	WIRE HARNESS, STACKER & DEFLECTOR	7-12, 7-13, 7-11
7716706	CABLE ASSY, HOLDER INTERNAL, USER SIDE	7-8
7717348	FLAT MYLAR CABLE, CLOSER	7-7
7723831	CABLE ASSY, DEFLECTOR MODULE, SENSORS	7-12
7716709	CABLE ASSY, PCB TO HOLDER MODULE	7-8, 7-13
7717347	FLAT MYLER, CABLE, HOLDER	7-8
7716711	CABLE ASSY, PCB TO ELEMENT FEEDER HEADER	7-4, 7-5, 7-6
7716712	CABLE ASSY, SHEET TAPPERS	7-11
7716713	CABLE ASSY, LCD	7-15
7716714	CABLE ASSY, INTERLOCK, ELEMENT FEEDER	7-15
7716715	CABLE ASSY, INTERLOCK, BOOK DRAWER	7-15
7716716	CABLE ASSY, INTERLOCK, TOP COVER	7-15
7716717	CABLE ASSY, ELEM. FEEDER MOVEABLE CABLE #1	7-4
7716718	CABLE ASSY, ELEM. FEEDER MOVEABLE CABLE #2	7-4
7716719	CABLE ASSY, ELEM. FEEDER MOVEABLE CABLE #3	7-6
7716720	CABLE ASSY, ELEM. FEEDER INTERNAL #1	7-4, 7-6
7716721	CABLE ASSY, ELEM. FEEDER INTERNAL #2	7-4
7716723	CABLE ASSY, 24VDC, ELEM. FEEDER INTERNAL	7-4
7716724	CABLE ASSY, 24VDC, ELEM. FEEDER MOVEABLE	7-4
7716725	CABLE ASSY, 24VDC, PCB TO MOTOR DRIVERS #1	7-4, 7-12, 7-12
7716726	CABLE ASSY, 24VDC, SUPPLY TO PCB	7-15
7716727	CABLE ASSY, AC, NEUTRAL, INLET FILER TO SWITCH	7-15
7717871	CABLE, SWITCH TO A-C BOARD, EWIRE	7-15
7716730	CABLE ASSY, PCB TO BOOK DRAWER	7-9

7716731	CABLE ASSY, BOOK DRAWER, MOVEABLE HARNESS	7-9
7716732	CABLE ASSY, BOOK DRAWER, MOVEABLE INTERNAL	7-9
7723828	CABLE ASSY, BYPASS MODULE	7-10
7716734	CABLE ASSY, PCB INTERLINK, B TO A	7-15
7716742	CABLE ASSY, PCB INTERLINK, B TO C	7-15
7723829	CABLE ASSY, ALIGNMENT MODULE	7-14
7716737	CABLE ASSY, ALIGNMENT MODULE SENSOR BOARD	7-14
7716738	CABLE ASSY, SKEW BOARD	7-14
7723830	CABLE ASSY, 24VDC, MOTOR DRIVERS #2	7-14
7716740	CABLE ASSY, 24VDC, MOTOR DRIVERS #3	7-10
7716741	WIRE HARNESS, SOL, DEFLECTOR MODULE	7-8, 7-7
7716743	CABLE ASSY, GROUND WIRE	7-15
7715525	GROUND WIRE	7-15
7717197	CABLE, STEPPER DRIVER TO MOTOR	7-14
7717472	CABLE ASSY, ELEM. TRANSFER, EXTENSION	7-5
7717473	CABLE ASSY, ELEM. TRANSFER, INTERNAL	7-5
7717199	CABLE STEERING, DRV TO HDR	7-12
7717198	CABLE STEERING, MTR TO HDR	7-12
7718656	COMMS EWIRE TO SPARTA, INTERNAL	7-15
7718556	JUMPER	7-15
7717870	CABLE, PSU TO A-C BOARD, EWIRE	7-15
7723151	CABLE, EXTENSION, VACUUM STACKER MOTOR	7-13
7715490	CABLE, USB 2.0, A MALE TO A FEMALE	7-15
7715537	CABLE, DEBUG TO PANEL	7-15
7723193	CABLE, EF SWITCH CLOSE	7-4
7723240	FLAT MYLAR CABLE, HOLDER	7-8
7723239	CABLE ASSY, HOLDER RIBBON ADAPTER	7-8
7723832	CABLE, STEPPER DRIVER TO MOTOR	7-10

○ System Wiring

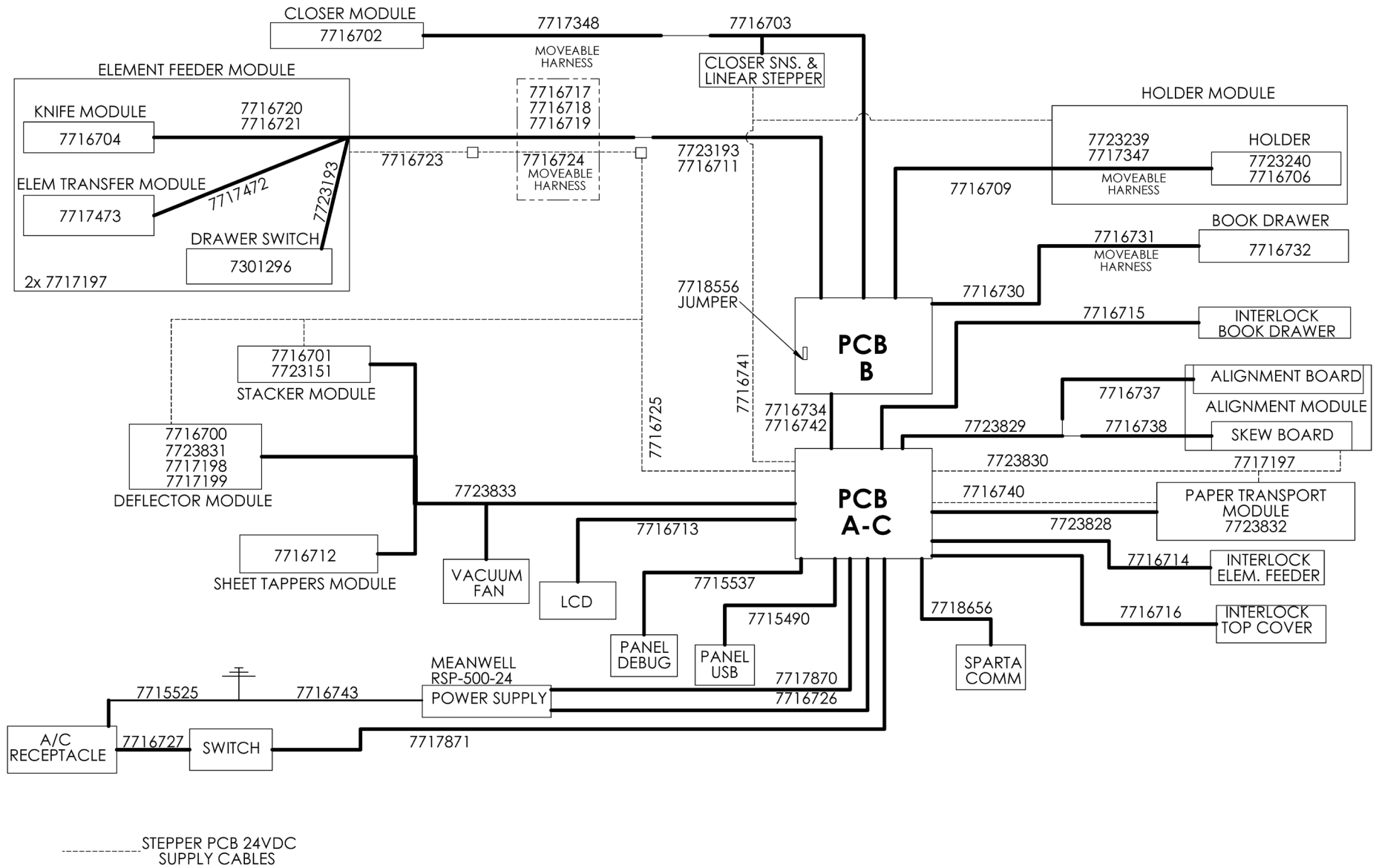



○ Element Feeder Module

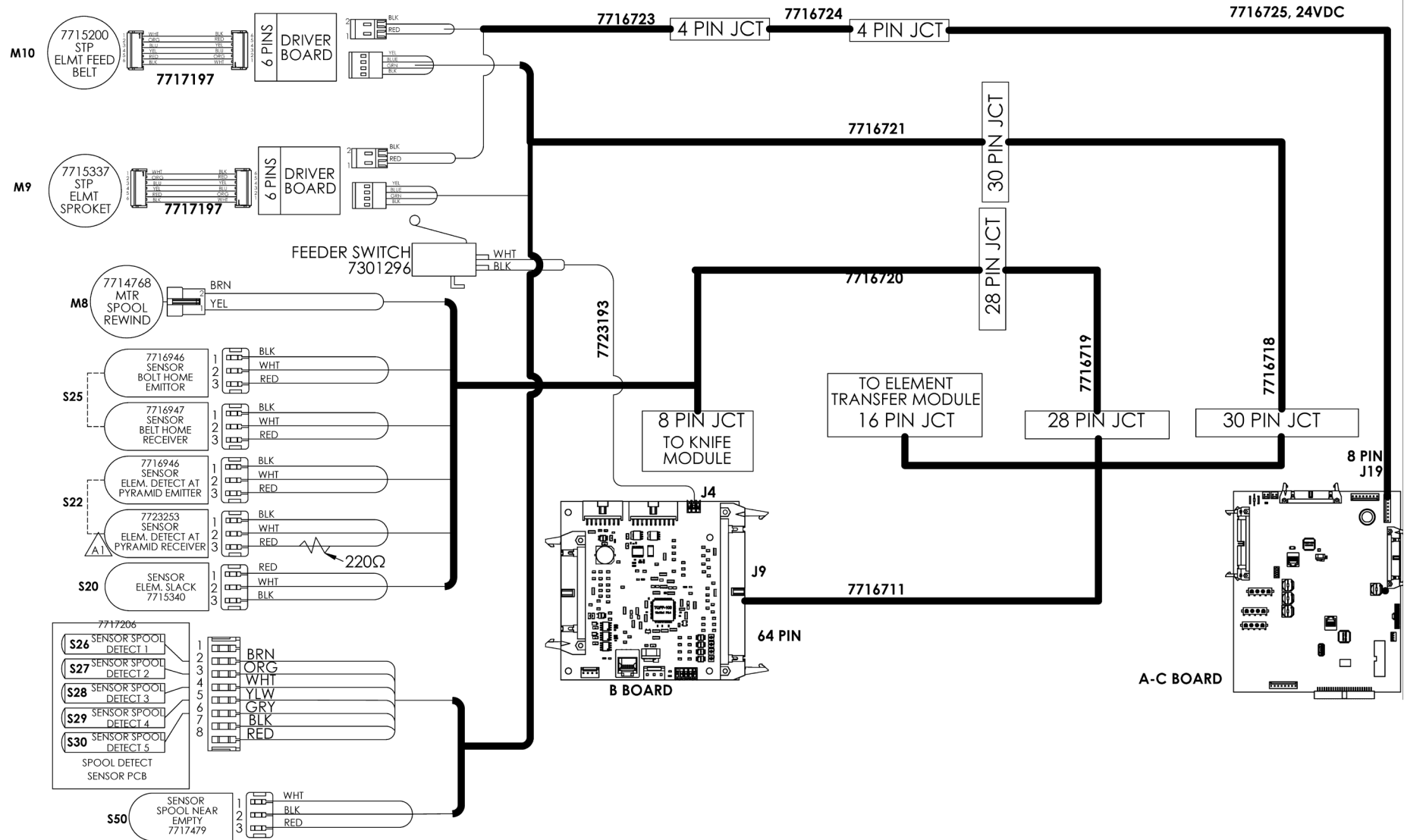

○ Element Transfer Module

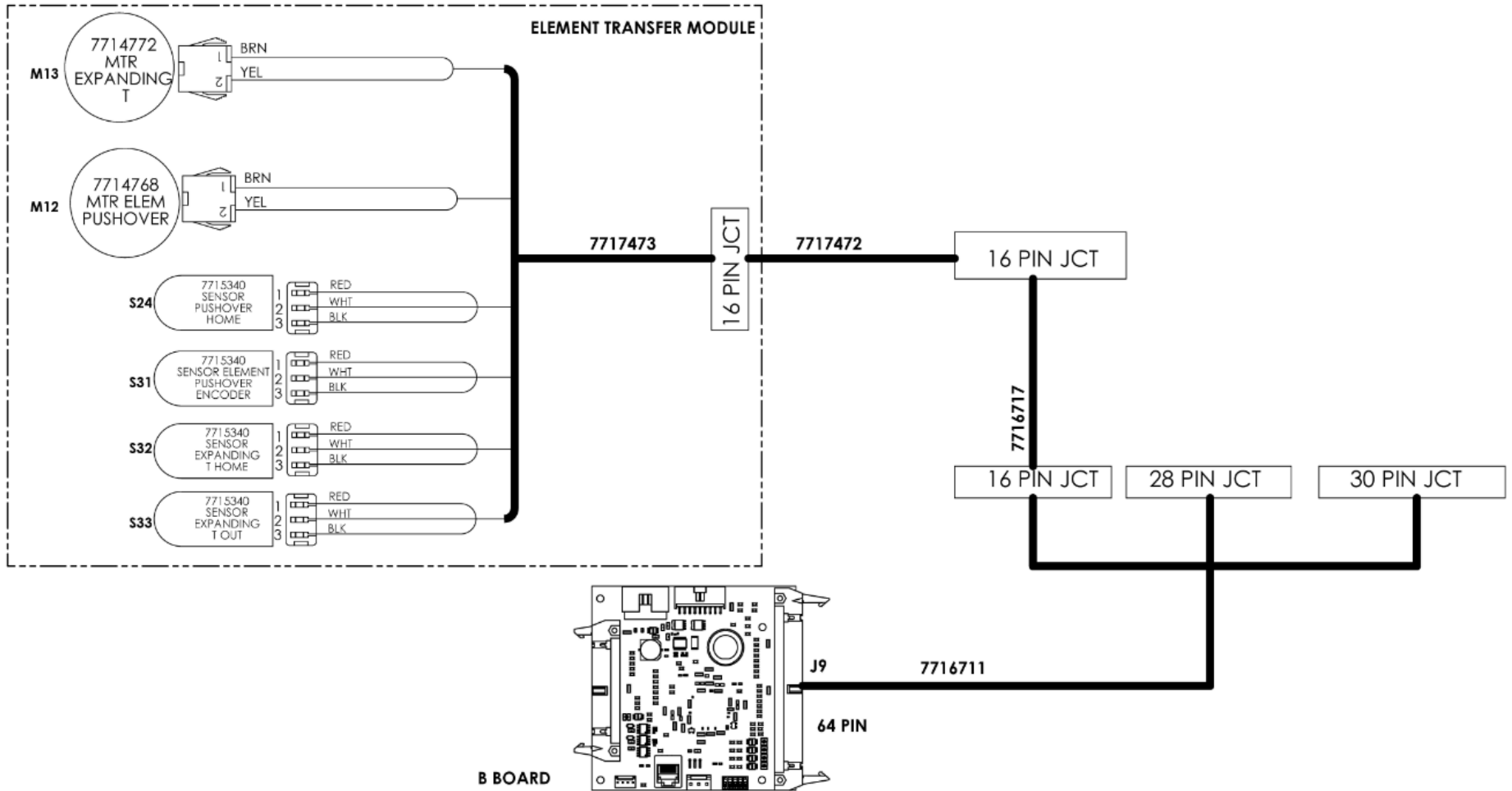

○ Knife Module

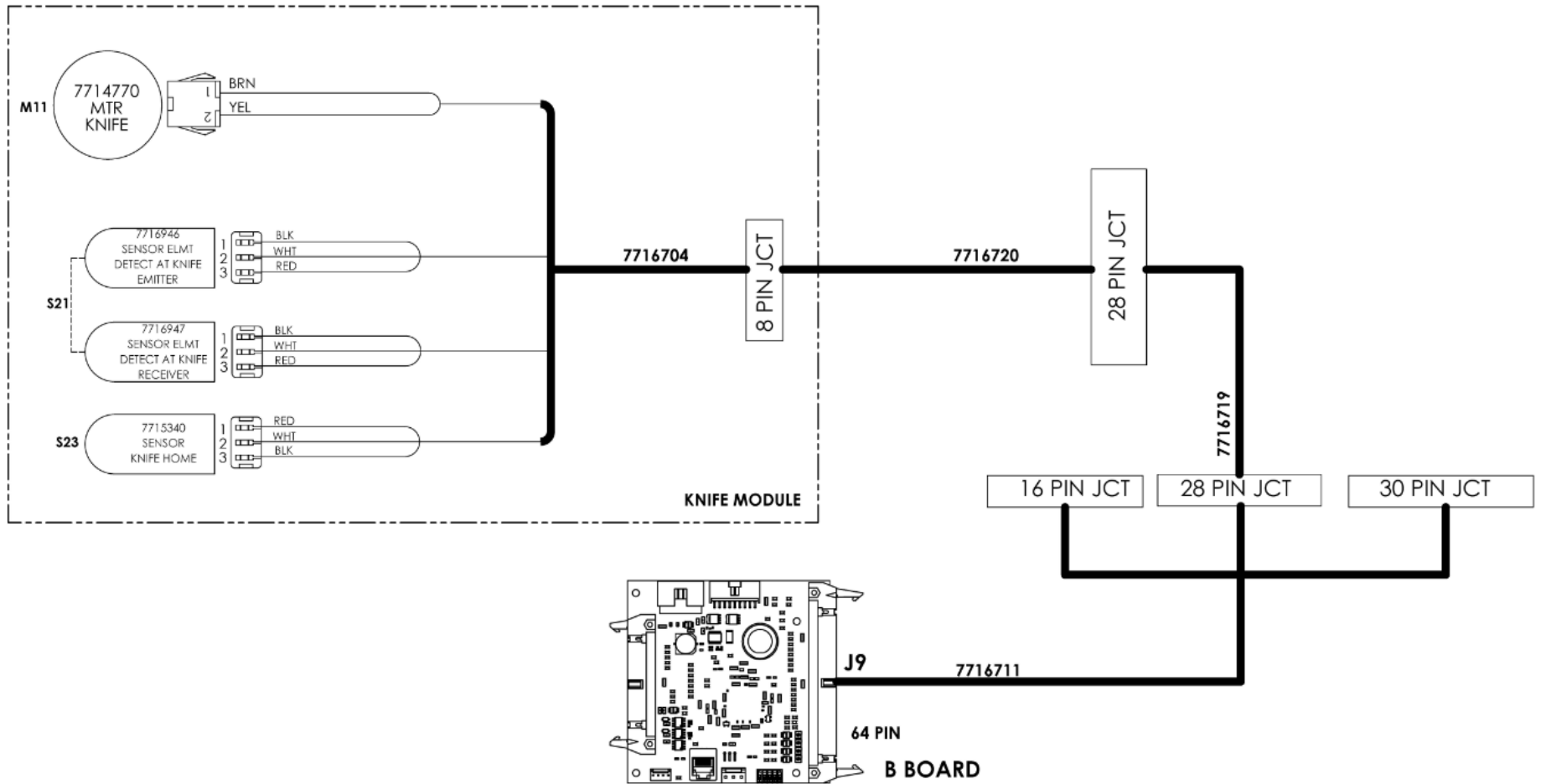

○ Closer Module

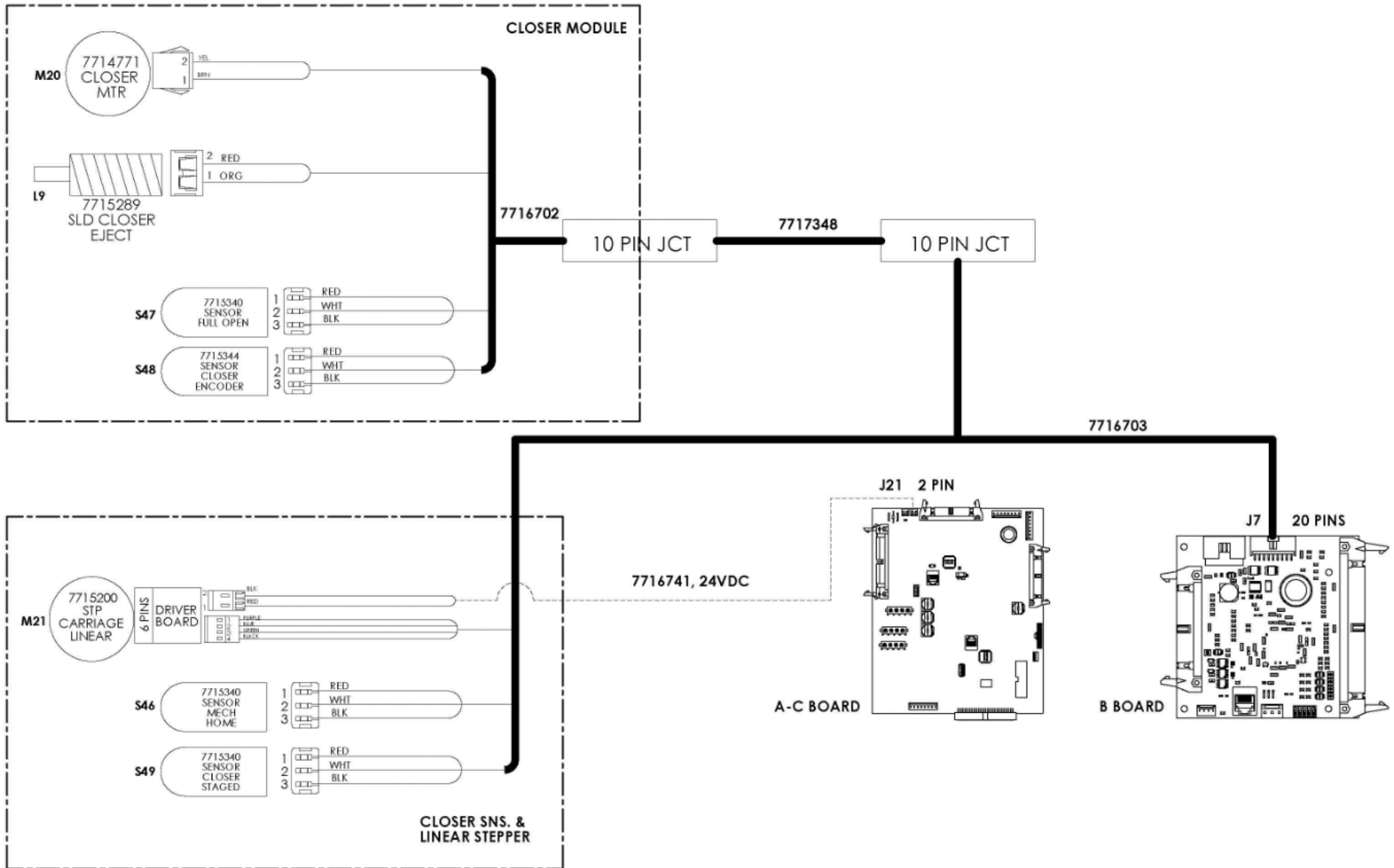

○ **Holder Module**

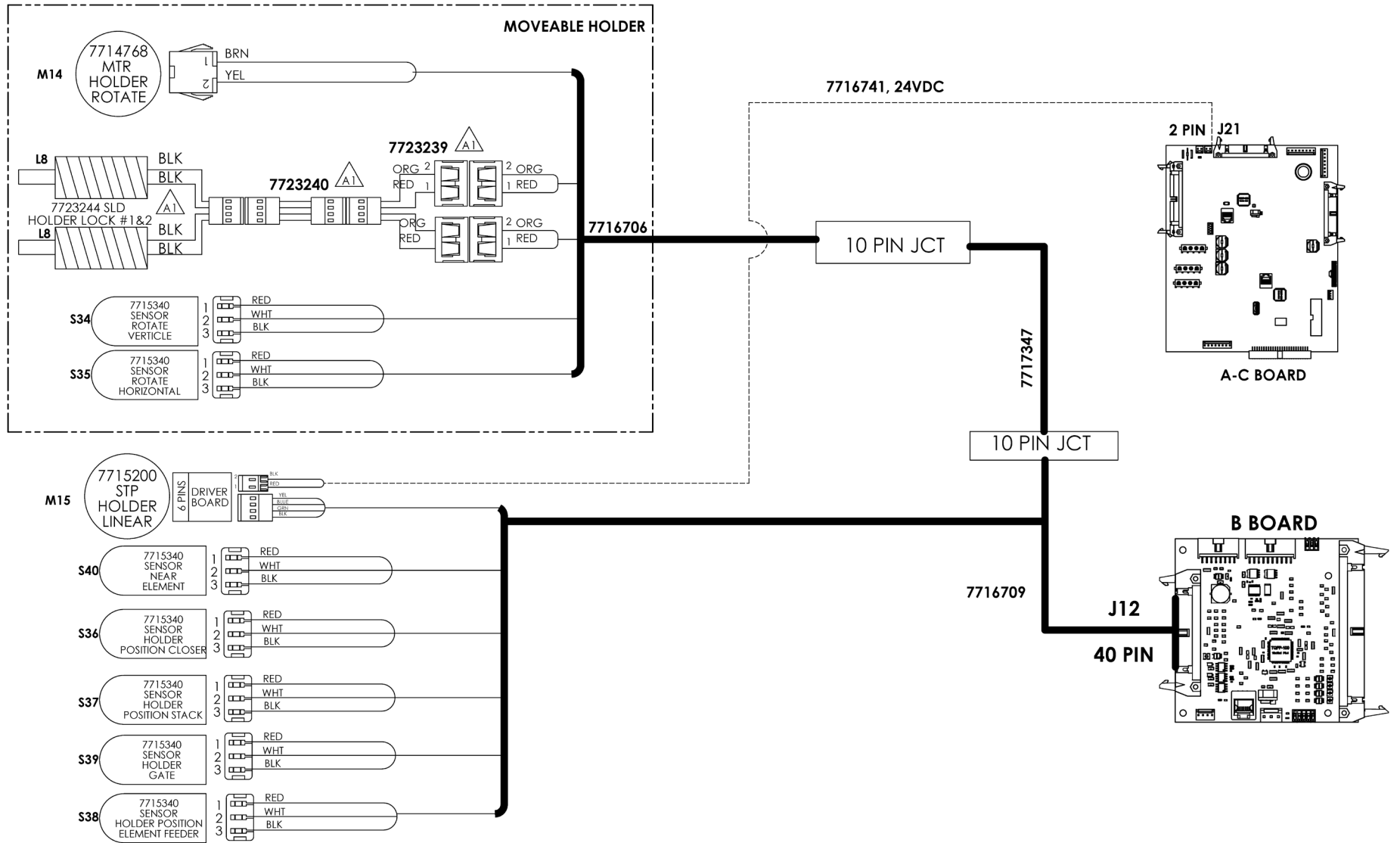

- Book Drawer

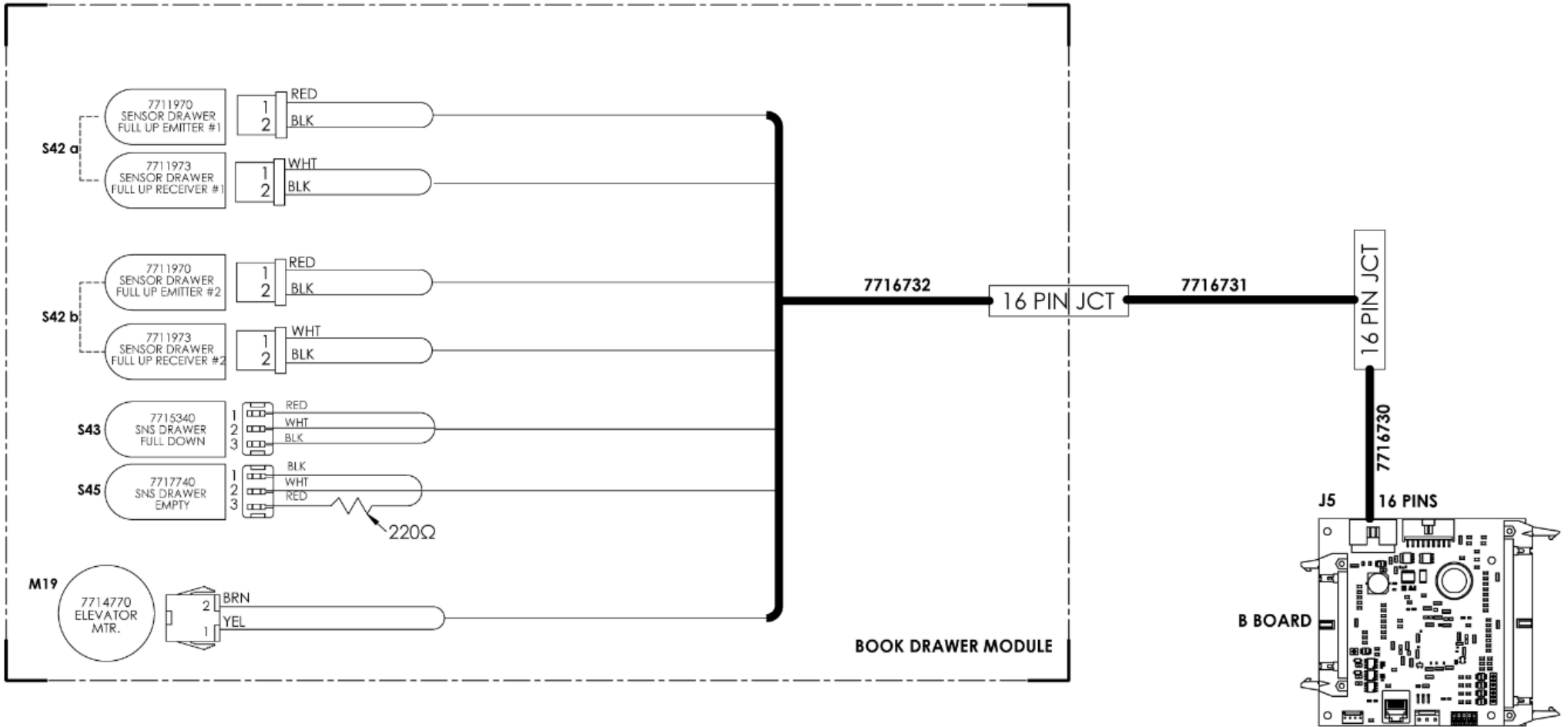

○ Paper Transport Module

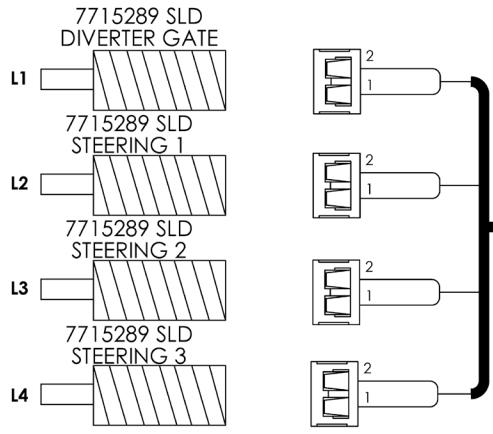
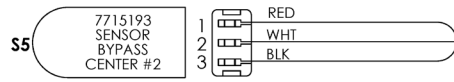
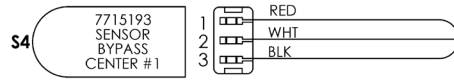
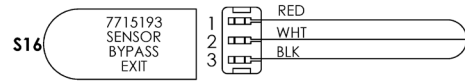
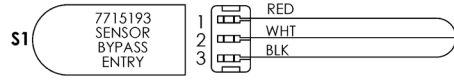
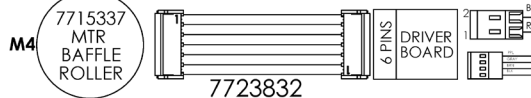
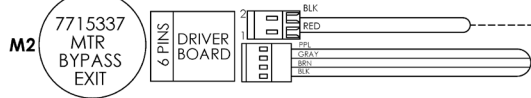
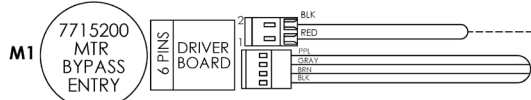

**BYPASS MODULE**

7723830, 24VDC

7716740, 24VDC

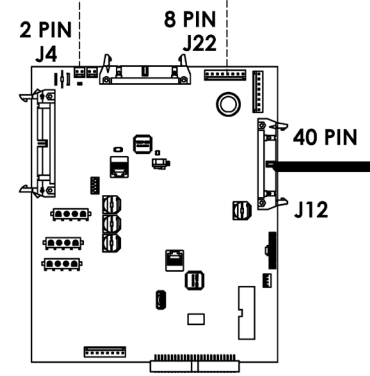

**A-C BOARD**

7723828

- Sheet Tappers Module

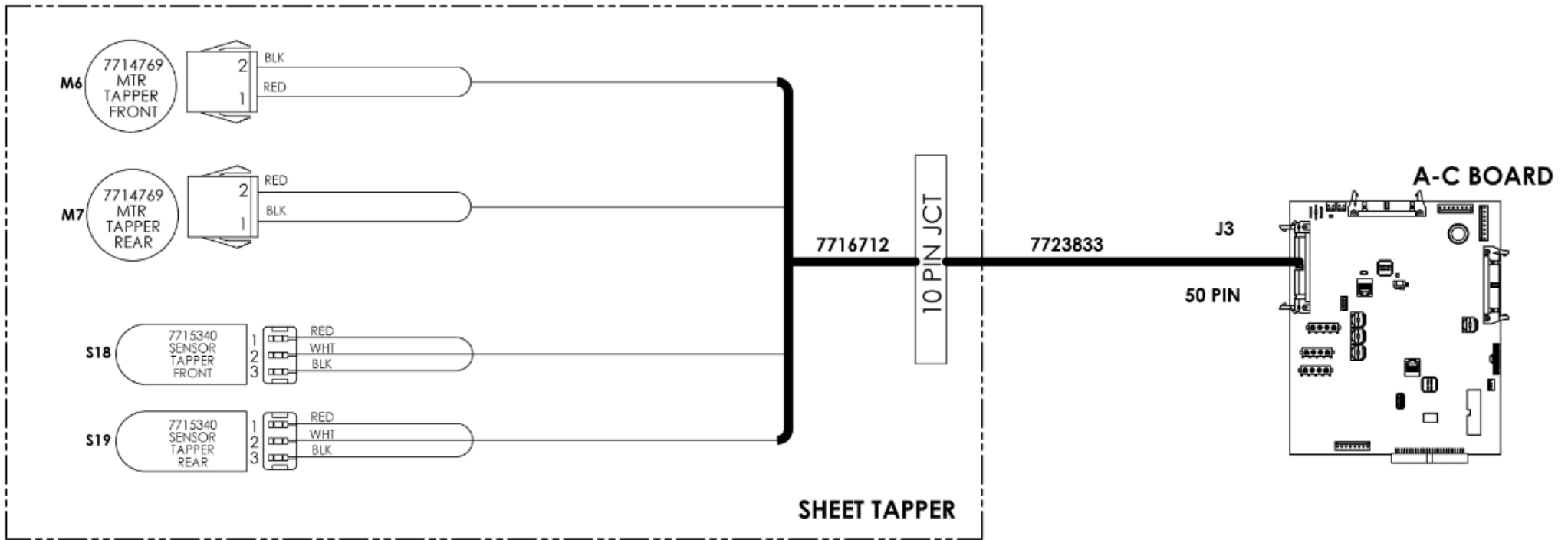



○ Deflector Module

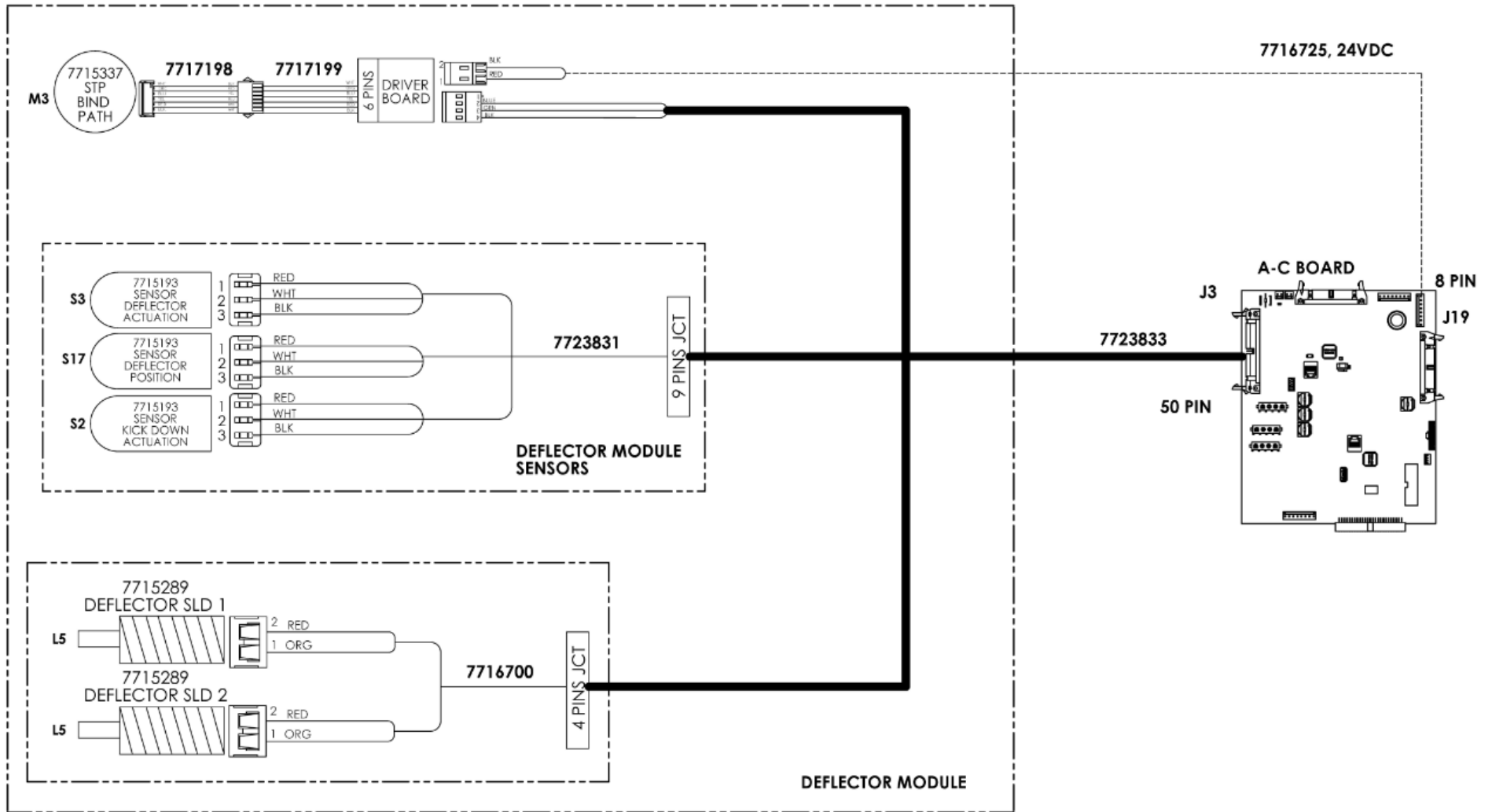

○ **Stacker Module**

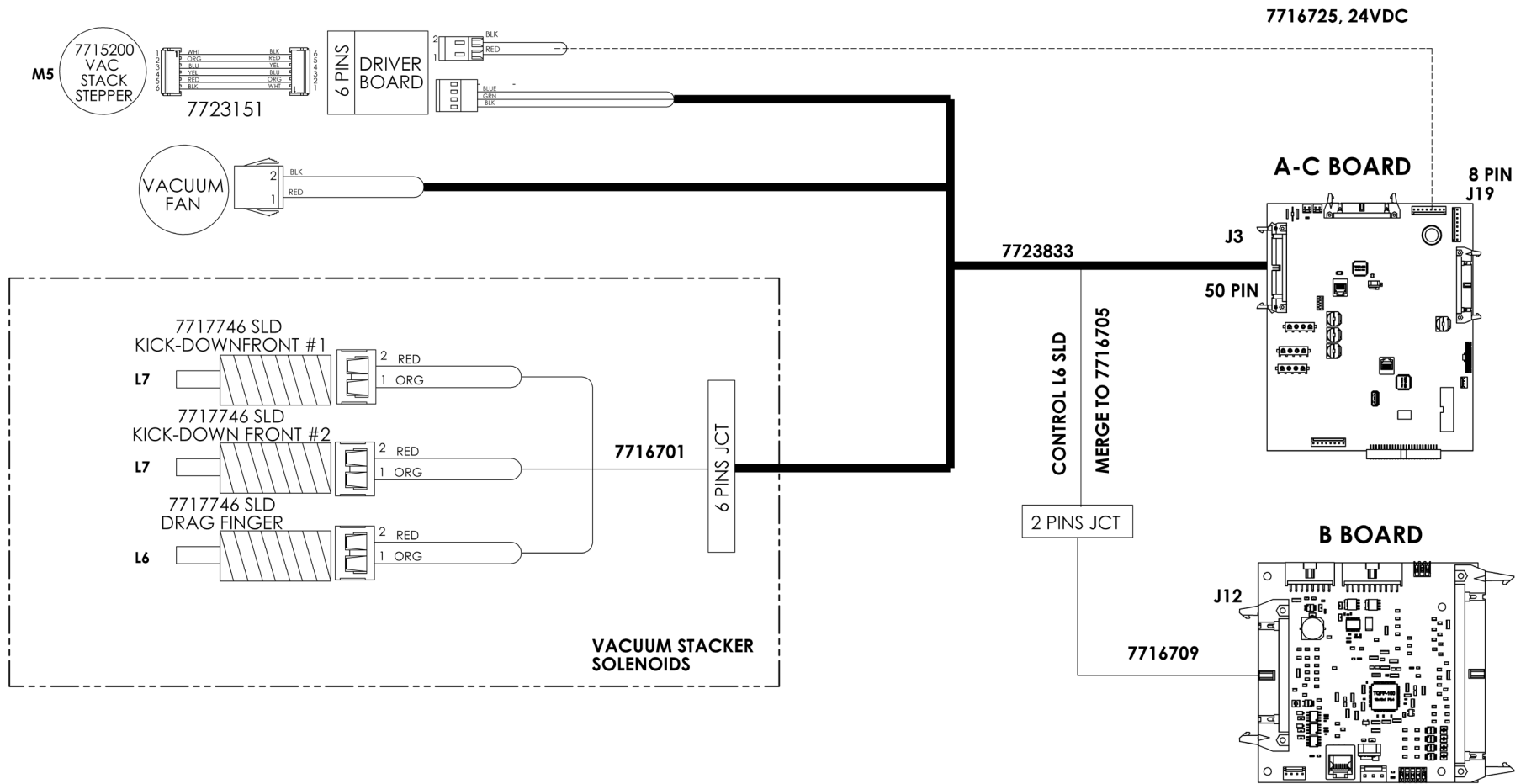

○ Alignment Module

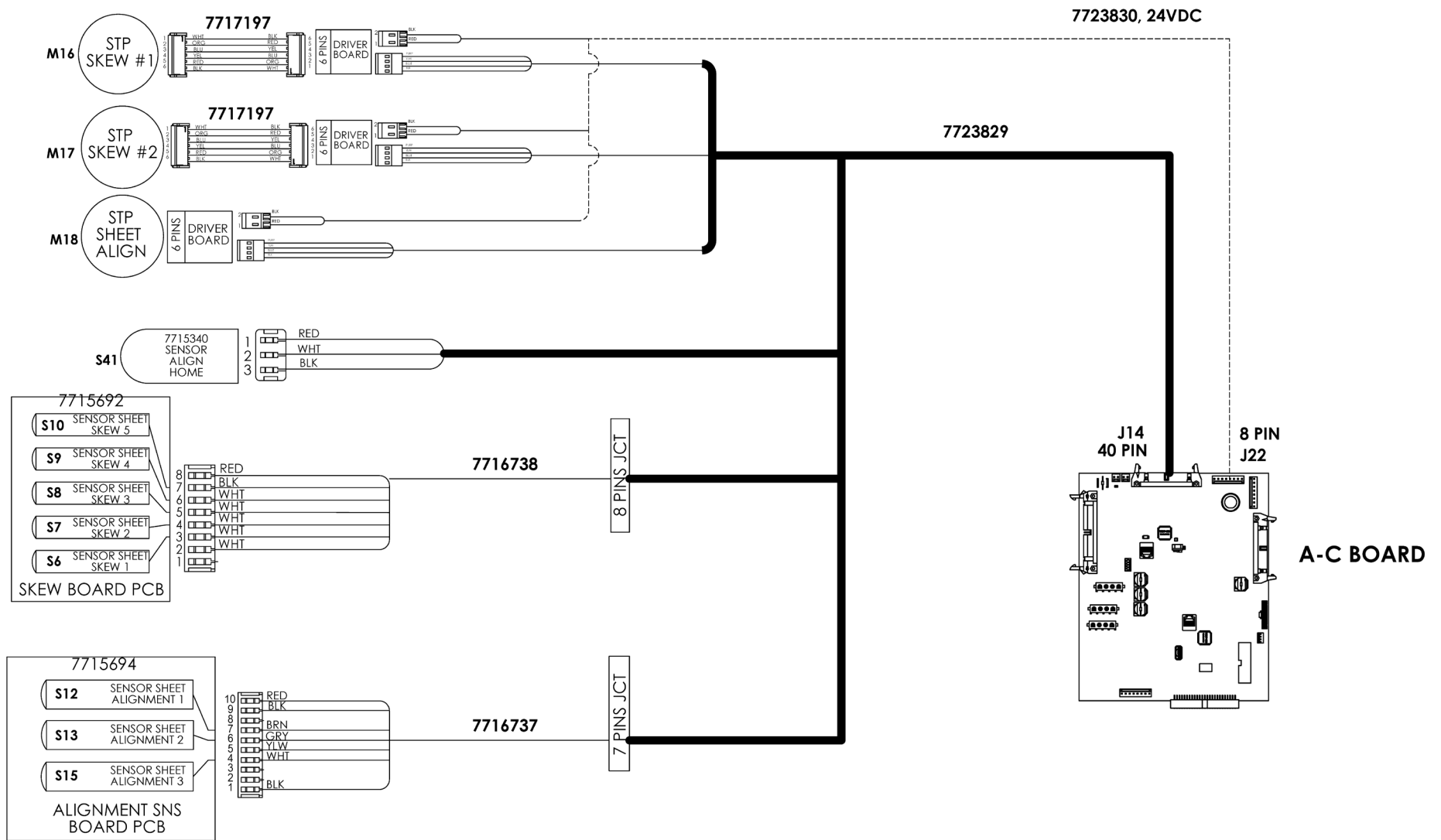

○ Interlock, AC, and LCD Connections

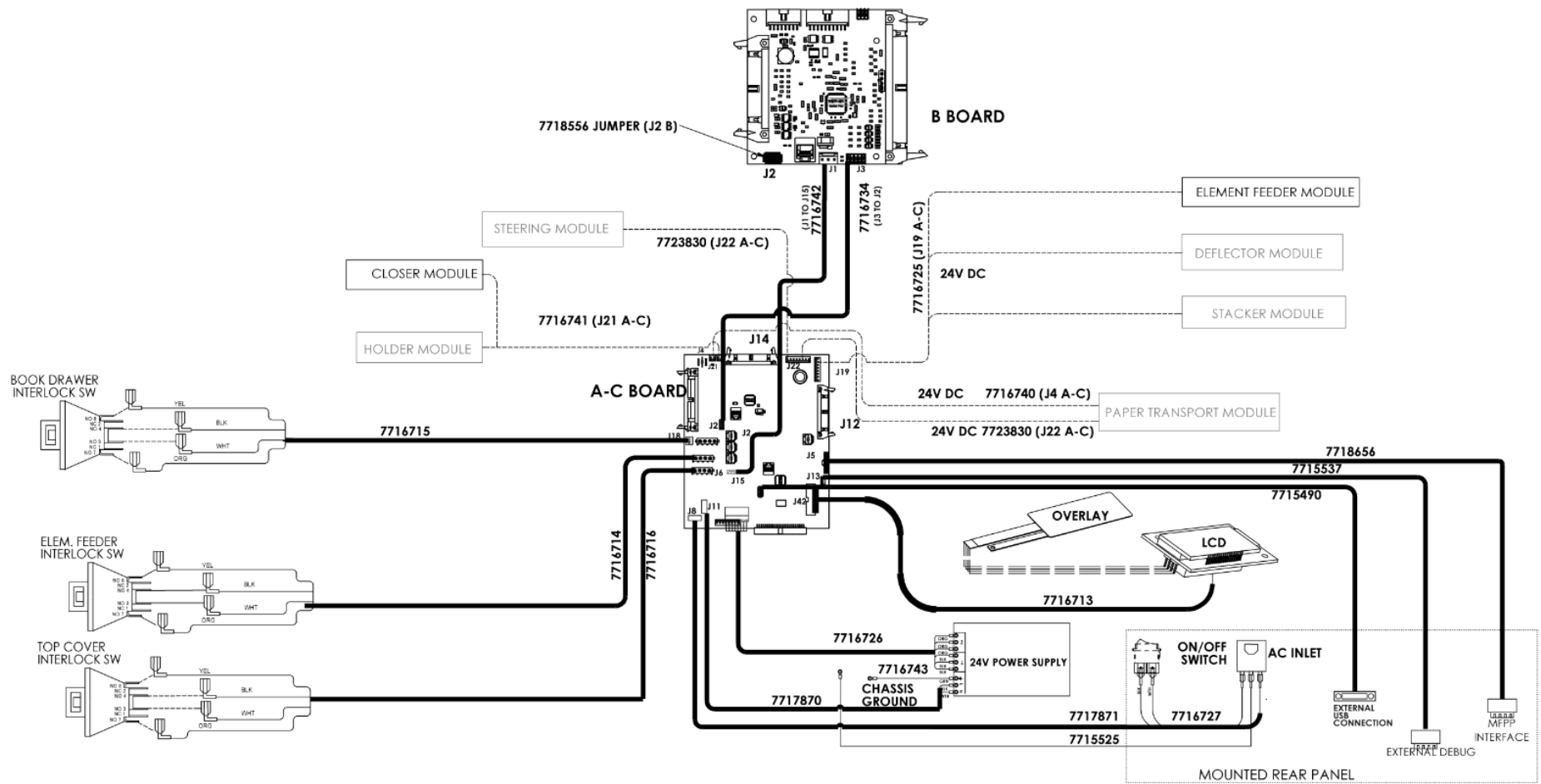

---

# 8. Installation Instructions

## Section Contents

Title	Page
8.1. Introduction .....	8-3
8.1.1 Check the Packing List.....	8-3
8.2. Installation Requirements .....	8-3
8.2.1 Space Requirements.....	8-3
8.2.1 Upstream Device Requirements .....	8-3
8.2.2 Required Tools .....	8-3
8.3. Remove the Packing Materials .....	8-4
8.4. Inspect for Damage.....	8-8
8.5. Prepare and Dock .....	8-8
8.5.1 Install Internal Communication Cable to MFPP-C1 ....	8-8
8.5.2 Prepare Docking Components .....	8-8
8.6. Vertical Alignment and Leveling of the eWire .....	8-12
8.7. Connection and Powering the eWire .....	8-13
8.8. Configure the eWire .....	8-14
8.9. Run eWire .....	8-14
8.10. User Manual.....	8-14

This page intentionally left blank.

## 8.1. Introduction

This section contains general installation points regarding the unpacking and setup of the eWire.

### 8.1.1 Check the Packing List

The eWire shipping material should contain 1 box with a wooden board on top:

- Pallet with eWire.
- Wooden board

The fully packed eWire measures 1270mm H x 1090mm W x 920mm L (50in H x 42.9 in W x 36.2 in L) and weighs 274 kgs (605 lbs)

## 8.2. Installation Requirements

### 8.2.1 Space Requirements

Before installing the eWire, make sure you have adequate space and clearance.

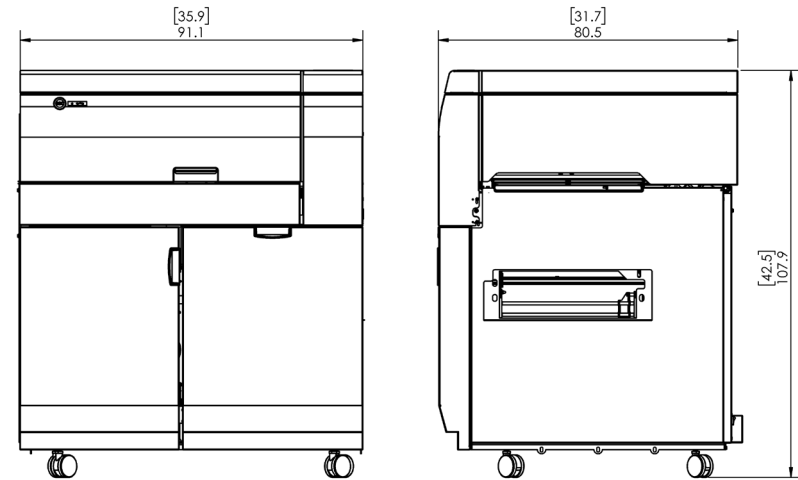

eWire System Dimensions

### 8.2.1 Upstream Device Requirements

### 8.2.2 Required Tools

The following tools are required to unpack and install the eWire.

- Utility knife or box cutter
- 17mm and 19mm open end wrenches
- 10mm socket wrench
- 7mm socket wrench or nut driver
- 200 gsm (or heavier) paper

### 8.3. Remove the Packing Materials

Do the following to remove all packing materials from the eWire.

1. Clear the space needed for the eWire.
2. Move the Shipping Container into position near where you will install the eWire



3. Remove the plastic shrink-wrap from the container and remove the packing Straps.
4. Remove the wooden ramp from the top of the shipping container. Do not discard the wooden ramp. It will be needed later to remove the eWire from the pallet.
6. Remove cardboard outer package by lifting it straight up off the eWire. Take care not to scrape the sides of the machine. Note: Two people should work together to lift the outer packaging, which is one large piece.
7. Remove the inner shrink wrap covering the eWire.

8. Open the element feeder door on the front left of the machine. Locate the shipping bracket at the bottom of the frame. Remove the M6 screw and remove the clamp plate from bracket. Remove the 2 x M10 bolts securing the support bracket to the pallet and remove the shipping bracket from the eWire.

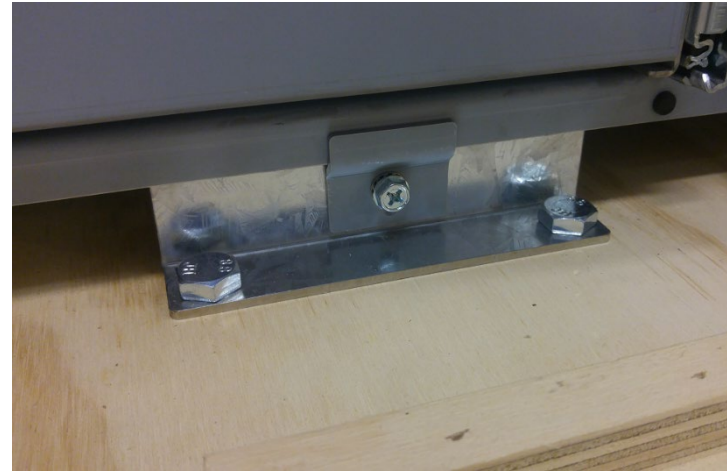

9. Repeat this procedure for the bracket located under the electrical panel at the rear of the machine.
10. Locate the shipping bracket on the left side of the machine. Remove the 3 x M6 screws securing the side bracket to the eWire. Remove the 5 x M10 bolts securing the shipping bracket to the pallet. Slide the bracket out from under the eWire and remove it.



11. Repeat for the opposite side bracket.



12. Remove the blocks and bolts (7723183 and 7709668) from the element feeder drawer. Place the ramp support blocks under the pallet, lining up the holes in the blocks with the holes in the pallet.



13. Place the wooden ramp onto the appropriate location on the front of the pallet. Secure the ramp in place using 2 long screws or Allen wrenches.

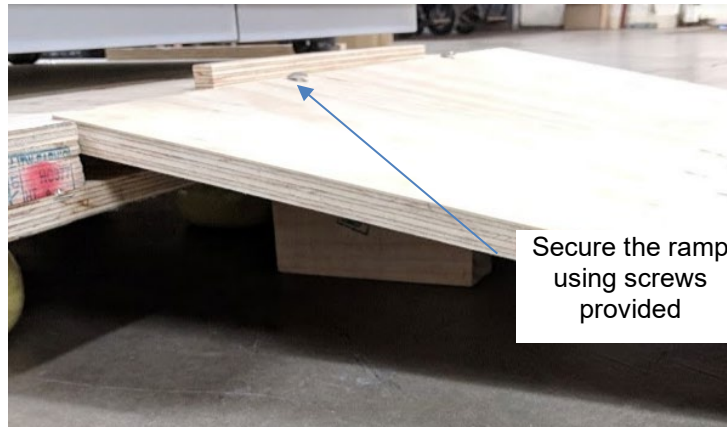

14. Using two people, carefully push the eWire from the back down the ramp. Make sure the eWire casters stay on the pallet and the ramp and control the machine on the way down. Make sure to support the eWire carefully while moving due to its weight.

15. Open the top cover and lift the lower bypass panel. Remove the shipping material in the book draw so that the drawer can open. Open the book drawer and remove the contents. Check all the parts are present before proceeding.



6200001	CORD SET, 115V
6200002	POWER CORD, EUROPE
6200014	POWER CORD, UK
6200015	POWER CORD, SWISS
7717700	INFEEED GUIDE ASSEMBLY, FWD, EWIRE
7718170	DOCKING PLATE, SPARTA TO EWIRE
7716522	CD, OPERATOR AND INSTALLATION MANUALS
7718072	FLEXIBLE MAGNET, ASSY, EWIRE
7717869	CABLE, DATA, EXTERNAL, EWIRE
1823903	SCREW, PHILLIPS HX HD W/SEMS M4 X 8 (Qty 8)
7718208	CABLE, LAN, COMMUNICATION
7708460	MIDWAY SHUNT CABLE
7717880	COVER, USB DRIVE, EWIRE
7723152	WIRE CUTTERS
7717879	TOOL, PUNCHED HOLE POSITION CHECK
7717881	EWIRE SETUP TOOL ASSEMBLY, ELEMENT HEIGHT
7709668	SCREW, CARRAIGE, 5/16-18X4" (Qty 2)
7723183	SUPPORT, PACKING, EWIRE

16. Using the wire cutters from the installation kit, remove the red cable tie from the handle. Lift the handle on the Vacuum Module and remove the bubble wrap from beneath the Vacuum Module.

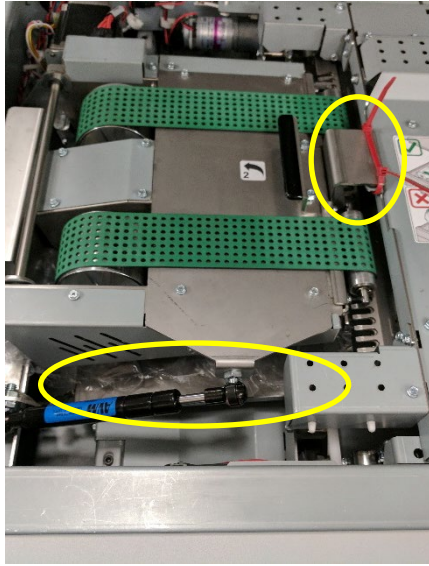

17. Remove the zip tie from the Drawer Lockout mechanism where shown.

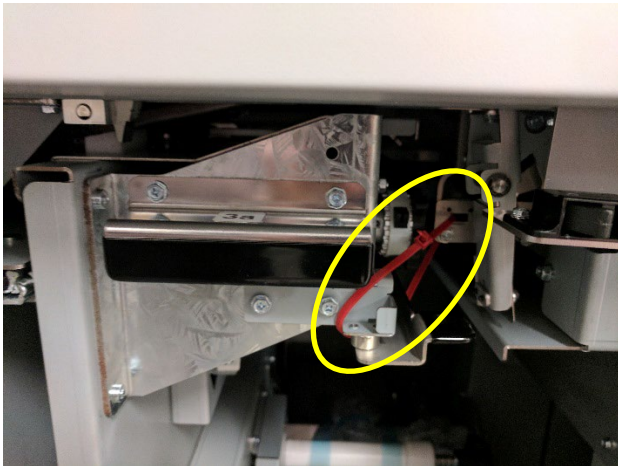

18. Remove the zip ties securing the closer module the side frame of the eWire.

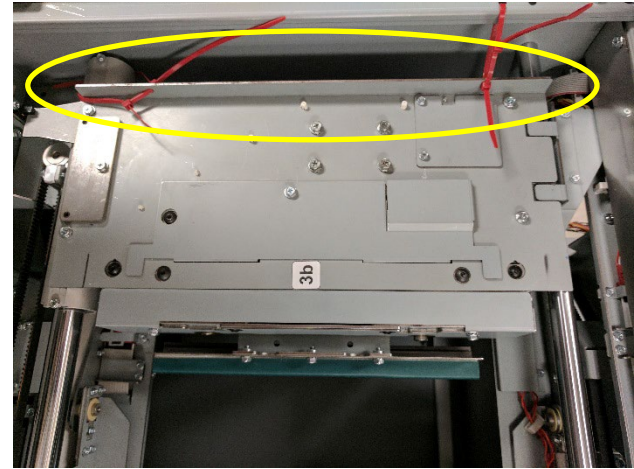

19. Move the closer module by hand to reveal the cable tie on the holder frame. Remove the cable tie.

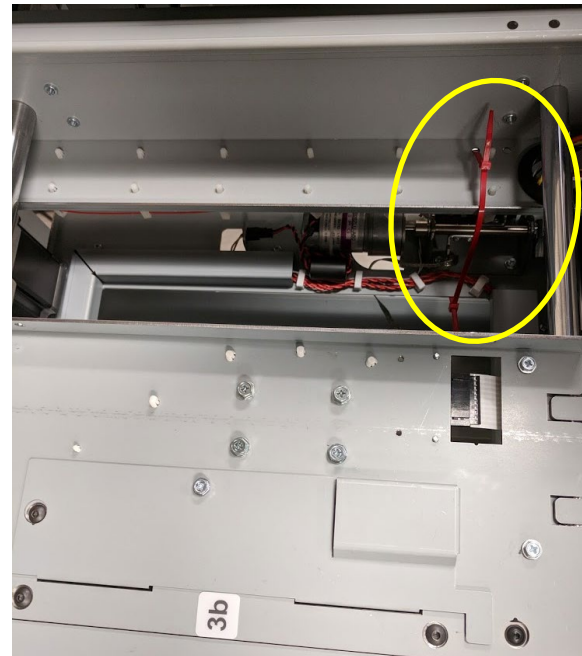

20. Remove the foam shipping blocks from the front and rear that keeping the holder in place.

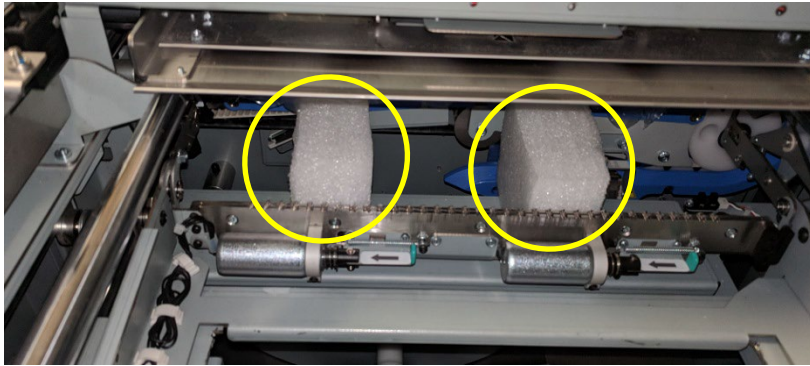

21. Place the spare magnet strips from the installation kit on the element feeder as shown below. When storing them on the element feeder, ensure that they are completely on the flat face of the drawer and are not near the spool.

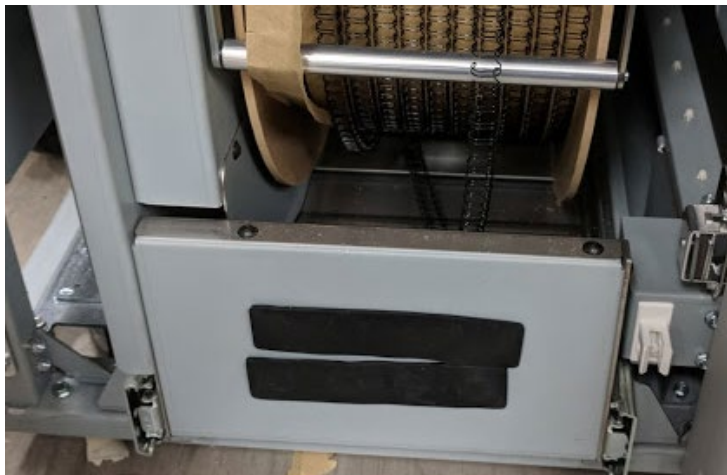

22. Take the wire cutters from the installation kit and install them into the triangular pocket located behind the element feeder door. Place the Element Height Setup Tool and the Punched Hole Position check tool on the inside of the book drawer as shown below.

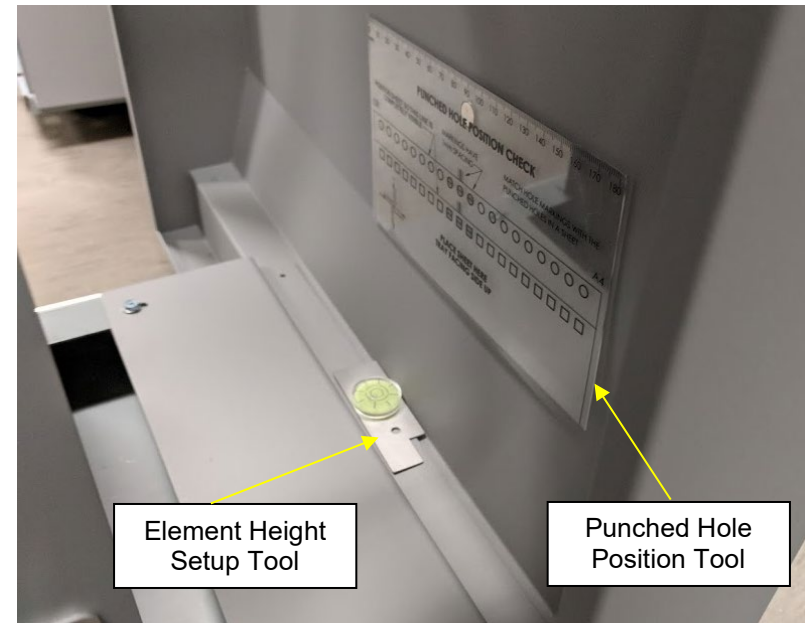

## 8.4. Inspect for Damage

1. Inspect the entire machine for damage. Make sure any damage that could affect the operation of the eWire is repaired.
2. Double check that all packaging (foam, zip ties, lock collars) has been removed from the eWire. Running the eWire with packaging material still in place could cause damage.

## 8.5. Prepare and Dock

### 8.5.1 Install Internal Communication Cable to MFPP-C1

If installing the MFPP-C1, then an internal communication cable must be installed. If you are installing the eWire with a MFPP-B1, then the cable comes pre-installed.

Install the Internal Communication Cable (7718656) on the MFPP-C1 main board. Connect one end into connection in the board shown below.

Remove the blank connector from the back panel of the MFPP-C1 and put the other end of 7718656 in its place. Make sure the panel mount is secure to prevent it from falling back into the punch when the external cable is connected.

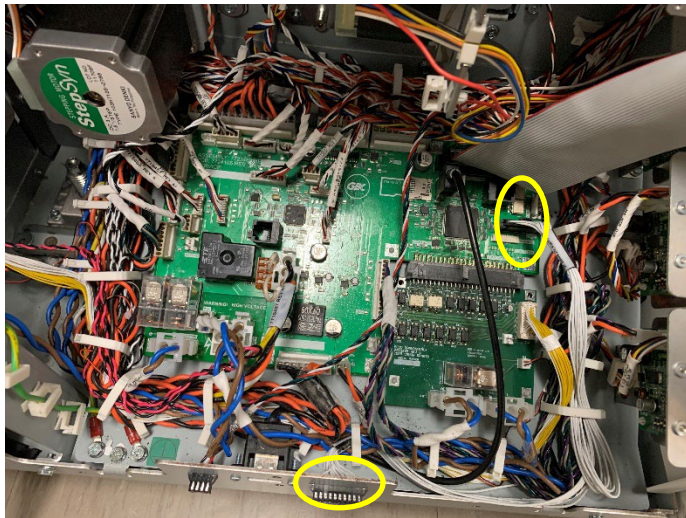

### 8.5.2 Prepare Docking Components

1. Locate the docking plate for the upstream MFPP-B1/C1 that was removed from behind the book drawer door.
2. Remove the M4 screw holding the docking plate to the eWire and set it aside for later.



3. Mount the docking plate to the upstream MFPP-B1/C1 device with the (4) M4 screws as shown below.

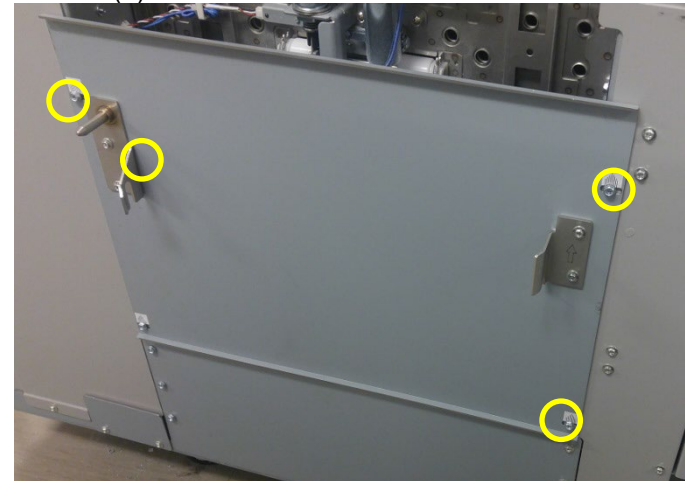

4. Set the plate so the middle marking is in line with the screw.



5. Remove the existing anti-static brush from the MFPP-B1/C1 exit plate.

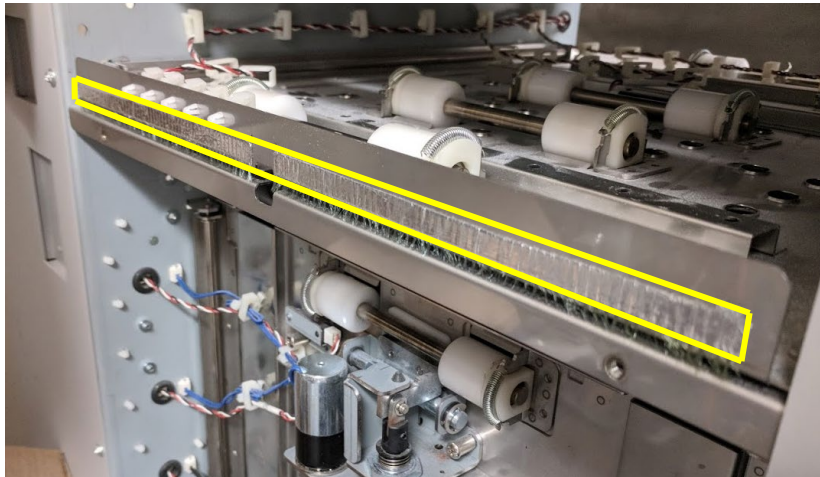

6. Attach the outfeed guide from the installation kit with (2) M4 screws provided in the installation kit.



7. Before docking, ensure that the paper path outfeed guide on the MFPP-B1/C1 is level with the infeed guide on the eWire. The paper path center line of the MFPP-B1/C1 outfeed guide should be vertically aligned with the center of the eWire infeed. Adjust the casters of eWire as necessary to achieve this. Refer to ADJ 1.12 in the service manual for instructions on caster adjustment.

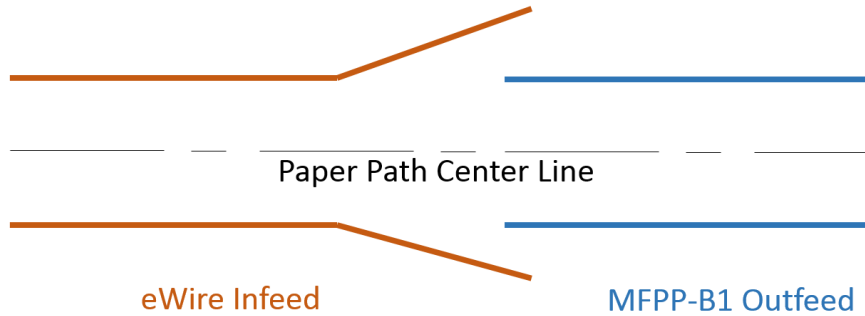

8. Line the alignment pin on the MFPP-B1/C1 mounting plate with the slotted hole on the eWire docking bracket.



9. After the machine is aligned with MFPP-B1/C1, push the eWire upstream to engage the docking mechanism on the eWire with the brackets on the MFPP-B1/C1.
10. Check that the sensor window at the exit of MFPP-B1/C1 aligns with the entrance sensor window of the eWire.

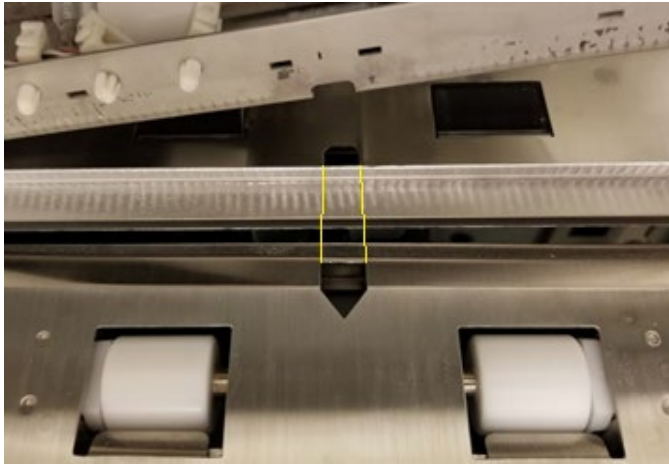

11. If the sensor windows do not align repeat step 4 and adjust the position of the docking plate. Adjust the plate position until the sensor windows are aligned.

12. Once docked, engage the docking lock by pushing the bracket in and securing it with the M4 screw removed on step 2.



## 8.6. Vertical Alignment and Leveling of the eWire

1. While maintaining the proper paper path height shown in section 8.5, adjust the height of the upstream casters of the eWire so that the top cover of the eWire is the same height as the top cover on the MFPP-B1/C1. Refer to ADJ 1.12 in the service manual for instructions on caster adjustment.
2. Check the level of the eWire front to rear on the upstream side of the top cover. Make adjustments to the upstream casters as necessary to level them while maintaining the correct paper path height.



3. Check the level of the eWire left to right. Adjust the downstream casters as necessary to level the machine in this direction.



4. Recheck the level of the front to back level of the cover at the upstream and downstream edges, and correct any level issues these may be off after performing step 3.
5. Dock the eWire to the upstream device and look through the gap on the upstream side of eWire. Confirm that the exit baffles of the upstream device are aligned vertically with the infeed baffles of the eWire. A piece of thick paper (200gsm or heavier) can be fed through the MFPP-B1/C1 into the eWire to better visual the height alignment.

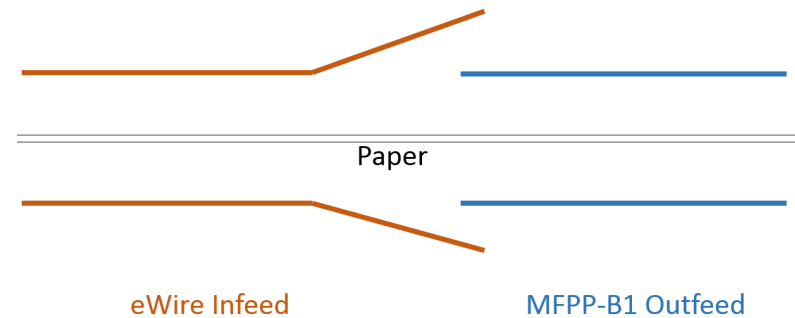

6. Once the eWire is the proper height and level, lock the casters in place as outline in ADJ 1.12



## 8.7. Connection and Powering the eWire

Do the following to power up the eWire.

1. Check the specifications of the input power to eWire is 115/230v 50/60 Hz.
2. Connect the ground cable between the eWire and finisher

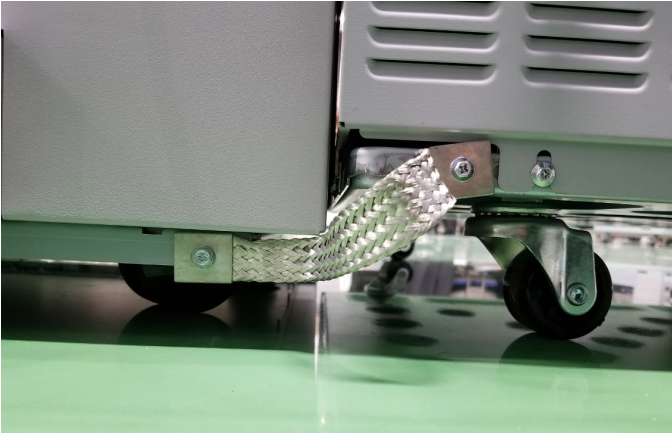

3. Connect the shunt cable 7708460 between the MFPP-B1/C1 and the eWire



4. Connect the Power Cord to the AC Filter on the rear of the eWire.
5. Remove the connector covers from eWire and the MFPP-B1/C1.
6. Replace the cover from the MFPP-B1/C1 with the extra cover found in the installation kit.
7. Thread the communication cable through the hole in the covers on each end.



8. Plug in the cable and replace the covers onto the eWire and MFPP-B1/C1.
9. Use the new longer LAN cable provided to reach around MFPP-B1/C1 and eWire.
10. Press the Power Switch to the On (I) position.

Once the full system is powered check the eWire LCD shows READY. If no element spool is installed the LCD will show ADD ELEMENTS. The eWire will not turn on immediately, the printer will control turning it on several minutes after the initial start up.

## 8.8. Configure the eWire

1. Do GP 6.2.4 LANGUAGE MODE Procedure to set the desired language.

## 8.9. Run eWire

1. Do GP 6.7 or refer to the user manual Section 6.B to install a supply spool.
2. Run a simple bypass job from the printer and check that the sheets transition correctly from upstream and downstream of eWire.
3. Complete the HOLDER TO XFER function test described in GP 6.3.4. Make sure the holder mates flush with the element feeder. Follow ADJ 1.3 and ADJ 1.16 if adjustment is needed to remove any gaps.
4. Feed an element per the function FEED ELEMENT test described in GP 6.3.4. Make sure the element feeds and moves to the stack position without issue. Check that the height of the element at the front and rear, in relation to the deflector, is the same using the element height tool described in ADJ 1.10.
5. Perform the Element Hook Position Adjustment ADJ 1.8 to make sure the alignment, skew and deflector timing are correct. The deflector timing can be done for every element size. Once the alignment and deskew is checked/adjusted for one element size it should not need to be done for other sizes.
6. Program the printer to feed a book job into the eWire and confirm that the eWire successfully creates a book.

## 8.10. User Manual

Make sure the customer has the *User Instructions Manual*.

Review the following sections of the user manual with the user to ensure they are familiar the operation and basic troubleshooting procedures. User knowledge of the sections indicated below will reduce jams and the need for service calls.

### Section 7 – User Operations

- A. Removing a supply spool from the machine
- B. Installing a new supply spool into the machine
- C. Supply spool storage
- D. Emptying the book drawer
- E. Clearing jams

### Section 9 – Problem Solving

This area lists the most likely causes of jam codes and errors. Review with the user the possible problem areas shown in the table in Section A

Point out the location of S22 sensor and the element slack sensor.

Ensure that no debris fell under the element slack sensor during the installation. Demonstrate to the user how to check and clean this area when you perform this check during the installation.